

ALTERA MAX10 Development & Education Board (DE10-Lite)

PAGE	CONTENT	PAGE	CONTENT
1	Cover Page	19	
2	Block Diagram	20	
3	MAX 10 Bank 1 & 2	21	
4	MAX 10 Bank 3 & 4	22	
5	MAX 10 Bank 5 & 6	23	
6	MAX 10 Bank 7 & 8	24	
7	MAX 10 Clocks	25	
8	MAX 10 Configuration	26	
9	MAX10 Power		
10	MAX10 Ground		
11	MAX10 Decoupling		
12	SDRAM		
13	GPIO and Arduino Interface		
14	LED, 7'Seg, User IO		
15	VGA and Accelerometer		
16	Power - 5V, 1.2V		
17	Power - 1.8V, 2.5V, 3.3V		
18	USB Blaster		

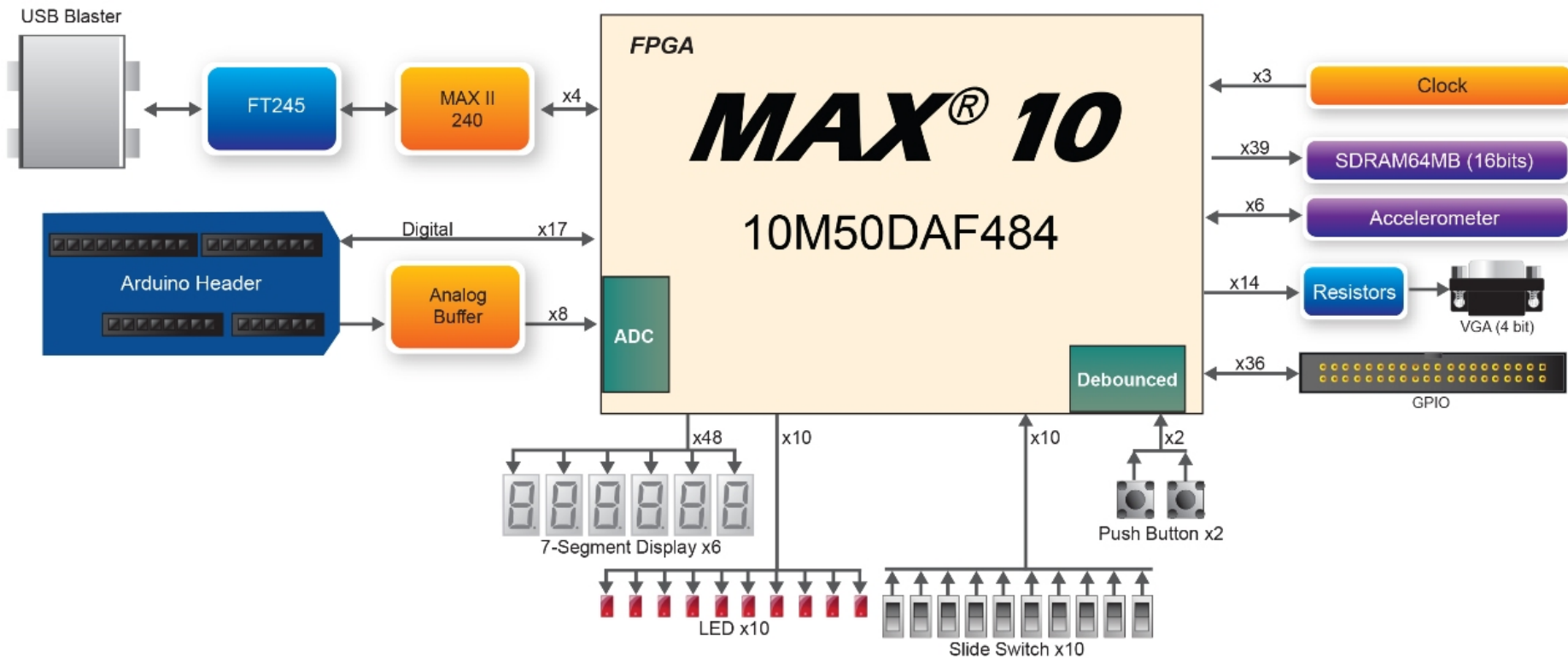

www.terasic.com

MAX10 Bank 3 & 4

GPIO 0

7,13 GPIO [35..0]

Arduino Digital Interface

13 Arduino IO[15..0]

Digital Accelerometer

15 GSENSOR_SDI

15 GSENSOR_SCLK

15 GSENSOR_INT1

15 GSENSOR_INT2

15 GSENSOR_CS_n

15 GSENSOR_SDO

VGA

15 VGA_R[3..0]

U5B

MAX 10 BOTTOM BANKS

BANK-3VCCIO = 3.3V

BANK-4VCCIO = 3.3V

GPIO 25	Y7	DIFFIO_RX_B10N	W11	GPIO_19	
GPIO 23	Y8	DIFFIO_RX_B10P	Y11	GPIO_17	
GPIO 34	AB2	DIFFIO_RX_B12N	AB10	GPIO_20	
GPIO 32	AB3	DIFFIO_RX_B12P	AB11	GPIO_18	
GPIO 33	Y3	DIFFIO_RX_B14N	AB12	GPIO_16	
GPIO 31	Y4	DIFFIO_RX_B14P	AB13	GPIO_15	
GPIO 30	AA5	DIFFIO_RX_B17N	W12	GPIO_14	
Arduino_IO0	AB5	DIFFIO_RX_B17P	W13	GPIO_13	
Arduino_IO1	AB6	DIFFIO_RX_B19N	AA14	GPIO_12	
Arduino_IO2	AB7	DIFFIO_RX_B19P	AB15	GSSENSOR_SCLK	
GPIO 24	AA8	DIFFIO_RX_B21N	AA15	GPIO_11	
Arduino_IO3	AB8	DIFFIO_RX_B21P	Y16		
GPIO 22	AA9	DIFFIO_RX_B23N	AB16	GSSENSOR_CS_n	
Arduino_IO4	AB9	DIFFIO_RX_B23P	AA16		
GPIO 9	V4	DIFFIO_RX_B2N	DIFFIO_RX_B42P	AB19	Arduino_IO10
VGA_R3	Y1	DIFFIO_RX_B2P	DIFFIO_RX_B44N	AB20	Arduino_IO13
VGA_R2	Y2	DIFFIO_RX_B4N	DIFFIO_RX_B44P	AA19	Arduino_IO11
VGA_R0	AA1	DIFFIO_RX_B4P	DIFFIO_RX_B46N	Y18	
GPIO 35	AA2	DIFFIO_RX_B6N	DIFFIO_RX_B46P	AB21	Arduino_IO14
GPIO 29	Y5	DIFFIO_RX_B8N	DIFFIO_RX_B50N	AA20	Arduino_IO15
GPIO 27	Y6	DIFFIO_RX_B8P	DIFFIO_RX_B50P	AB17	Arduino_IO8
GPIO 3	W9	DIFFIO_TX_RX_B11N	DIFFIO_RX_B58N	AB18	
GPIO 1	W10	DIFFIO_TX_RX_B11P	DIFFIO_RX_B58P	V11	GSSENSOR_SDI
GPIO 7	W7	DIFFIO_TX_RX_B13N	DIFFIO_TX_RX_B24N	V12	GSSENSOR_SDO
GPIO 5	W8	DIFFIO_TX_RX_B13P	DIFFIO_TX_RX_B24P	R12	
	R10	DIFFIO_TX_RX_B15N	DIFFIO_TX_RX_B26N	P12	
	P10	DIFFIO_TX_RX_B15P	DIFFIO_TX_RX_B26P	AA11	Arduino_IO6
GPIO 28	AA6	DIFFIO_TX_RX_B16N	DIFFIO_TX_RX_B28N	AA12	Arduino_IO7
GPIO 26	AA7	DIFFIO_TX_RX_B16P	DIFFIO_TX_RX_B28P	V13	
GPIO 10	W5	DIFFIO_TX_RX_B18N	DIFFIO_TX_RX_B34N	W14	
GPIO 8	W6	DIFFIO_TX_RX_B18P	DIFFIO_TX_RX_B34P	R13	
Arduino_IO5	Y10	DIFFIO_TX_RX_B22N	DIFFIO_TX_RX_B36N	P13	
GPIO 21	AA10	DIFFIO_TX_RX_B22P	DIFFIO_TX_RX_B36P	Y13	GSSENSOR_INT2
	U6	DIFFIO_TX_RX_B3N	DIFFIO_TX_RX_B37N	Y14	GSSENSOR_INT1
	U7	DIFFIO_TX_RX_B3P	DIFFIO_TX_RX_B37P	V14	
	W4	DIFFIO_TX_RX_B5N	DIFFIO_TX_RX_B39N	W15	
	W3	DIFFIO_TX_RX_B5P	DIFFIO_TX_RX_B39P	U15	
GPIO 6	V7	DIFFIO_TX_RX_B7N	DIFFIO_TX_RX_B41N	V16	
GPIO 4	V8	DIFFIO_TX_RX_B7P	DIFFIO_TX_RX_B41P	AA17	Arduino_IO9
	R9	DIFFIO_TX_RX_B9N	DIFFIO_TX_RX_B43N	Y17	
	P9	DIFFIO_TX_RX_B9P	DIFFIO_TX_RX_B43P	V15	
	AA3	DIFFIO_TX_RX_B9N	DIFFIO_TX_RX_B45N	W16	
	AB4	VREFB3N0	DIFFIO_TX_RX_B45P	Y19	Arduino_IO12
		IO_BANK3	DIFFIO_TX_RX_B49N	W18	
			DIFFIO_TX_RX_B49P	AA13	
			VREFB4N0	AB14	
			IO_BANK4		

10M50DAF484

MAX10 Bank 5 & 6

SDRAM

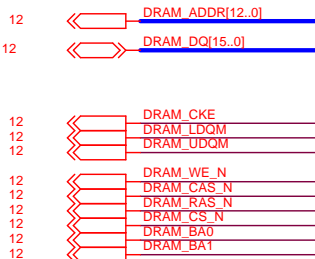

SWITCH



KEY



LED



7-segment Display

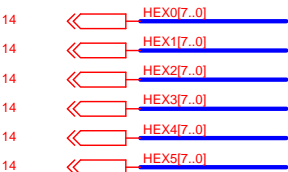

U5C

MAX 10 RIGHT BANKS



10M50DAF484

MAX10 Bank 7 & 8

7-segment Display

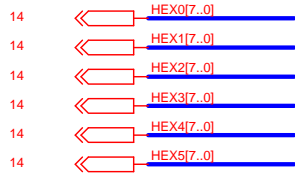

SWITCH

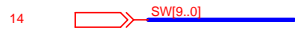

KEY



LED



Arduino Digital Interface



U5D

MAX 10 TOP BANKS

BANK-7VCCIO = 3.3V

BANK-8VCCIO = 2.5V

HEX14	A17	DIFFIO_RX_T10N	DIFFIO_RX_T39N	C7
HEX15	A18	DIFFIO_RX_T10P	DIFFIO_RX_T39P	C8
HEX02	C15	DIFFIO_RX_T15N	DIFFIO_RX_T41N	A6
HEX03	C16	DIFFIO_RX_T15P	DIFFIO_RX_T41P	B7
HEX17	A16	DIFFIO_RX_T16N	DIFFIO_RX_T42P	D8
HEX13	B16	DIFFIO_RX_T16P	DIFFIO_RX_T42P	A4
	J13	DIFFIO_RX_T17N	DIFFIO_RX_T43N	A5
	H14	DIFFIO_RX_T17P	DIFFIO_RX_T43P	E9
LEDR5	C13	DIFFIO_RX_T18N	DIFFIO_RX_T44N	A2
HEX00	C14	DIFFIO_RX_T18P	DIFFIO_RX_T45P	A3
SW8	B14	DIFFIO_RX_T19N	DIFFIO_RX_T45N	B3
SW7	A14	DIFFIO_RX_T19P	DIFFIO_RX_T46P	B4
HEX01	E15	DIFFIO_RX_T19P	DIFFIO_RX_T46N	B5
HEX04	E16	DIFFIO_RX_T1N	DIFFIO_RX_T47P	C4
	E13	DIFFIO_RX_T1P	DIFFIO_RX_T47N	E8
LEDR7	D14	DIFFIO_RX_T20N	DIFFIO_RX_T48P	D5
	E12	DIFFIO_RX_T20P	DIFFIO_RX_T48P	C5
LEDR4	D13	DIFFIO_RX_T21P	DIFFIO_RX_T49P	B1
	J12	DIFFIO_RX_T21N	DIFFIO_RX_T51N	B2
	H13	DIFFIO_RX_T22N	DIFFIO_RX_T51P	C2
	A12	DIFFIO_RX_T22P	DIFFIO_RX_T53N	C3
SW4	A12	DIFFIO_RX_T23N	DIFFIO_RX_T53P	D7
SW6	A13	DIFFIO_RX_T23P	VREFB8N0	D7
SW2	D12	DIFFIO_RX_T24N	IO_BANK8	C6
SW3	C12	DIFFIO_RX_T24P		
LEDR2	A10	DIFFIO_RX_T25N		
LEDR8	A11	DIFFIO_RX_T25P		
SW0	C10	DIFFIO_RX_T26N		
SW1	C11	DIFFIO_RX_T26N		
LEDR9	B11	DIFFIO_RX_T26P		
SW5	B12	DIFFIO_RX_T27N		
	J11	DIFFIO_RX_T27P		
	H12	DIFFIO_RX_T28N		
	B8	DIFFIO_RX_T28P		
KEY0	A9	DIFFIO_RX_T31N		
LEDR1	A9	DIFFIO_RX_T31P		
HEX06	C17	DIFFIO_RX_T2N		
HEX05	D17	DIFFIO_RX_T2P		
	C9	DIFFIO_RX_T30N		
LEDR3	B10	DIFFIO_RX_T30N		
KEY1	A7	DIFFIO_RX_T30P		
LEDR0	A8	DIFFIO_RX_T29P		
SW9	F15	DIFFIO_RX_T29N		
Arduino_Reset_n	F16	DIFFIO_RX_T5N		
HEX22	B19	DIFFIO_RX_T5P		
HEX33	C19	DIFFIO_RX_T6N		
HEX16	B17	DIFFIO_RX_T6P		
HEX10	C18	DIFFIO_RX_T7N		
HEX27	A19	DIFFIO_RX_T7P		
HEX21	A20	DIFFIO_RX_T8N		
LEDR6	E14	DIFFIO_RX_T8P		
	D15	DIFFIO_RX_T9N		
HEX07	D15	DIFFIO_RX_T9P		
	B15	VREFB7N0		
	A15	IO_BANK7		

10M50DAF484

MAX10 Clock

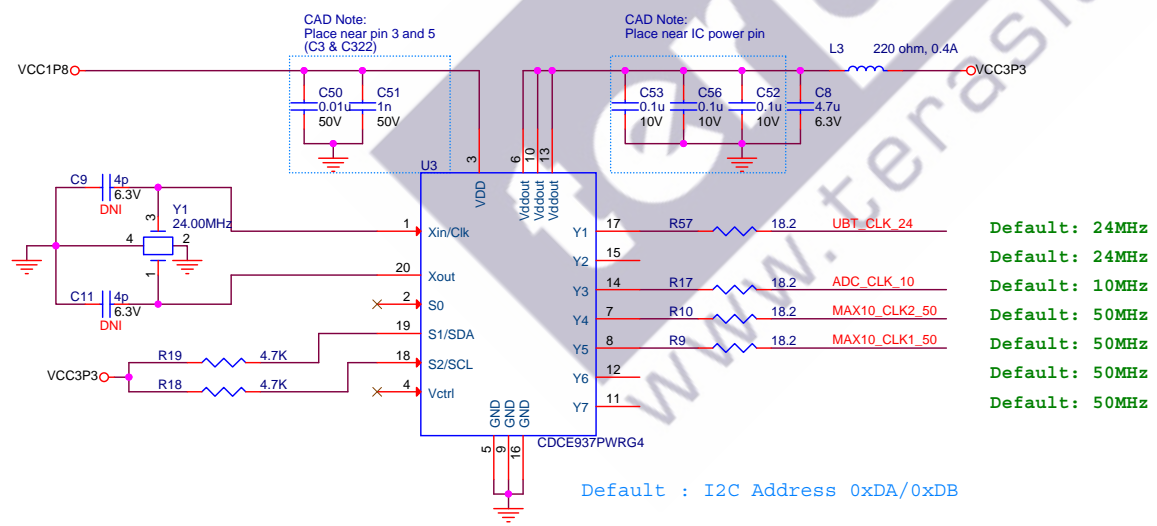
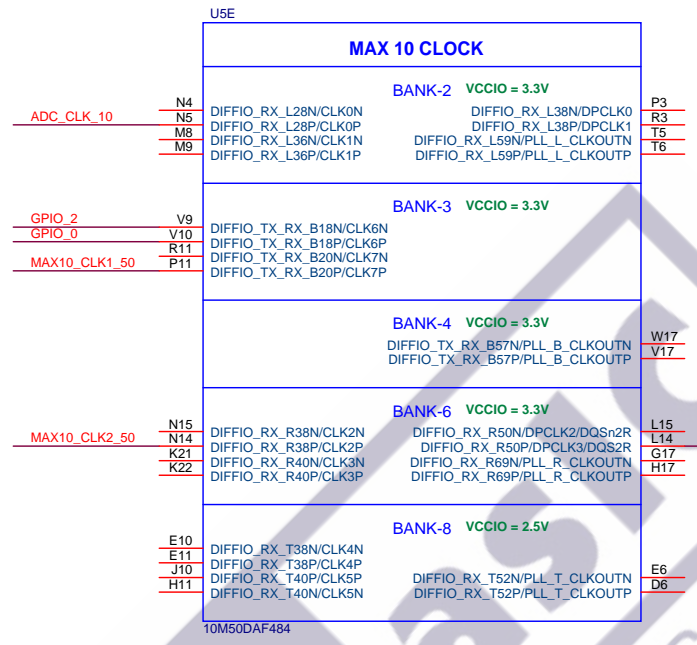
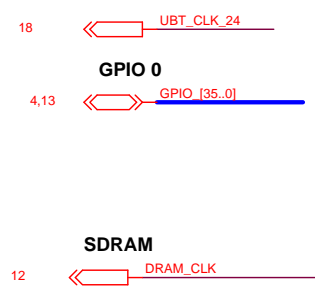

MAX10 Configuration

JTAG Interface



FPGA CONFIG

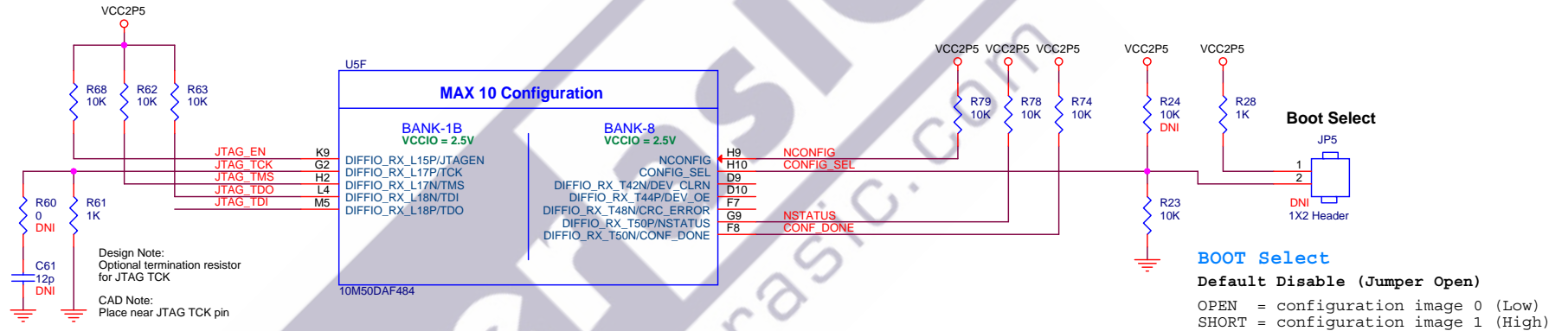
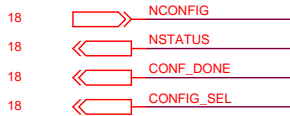

MAX10 Power

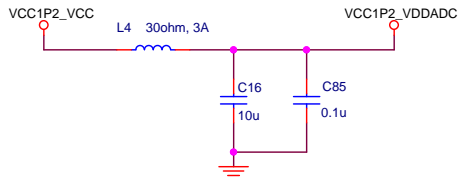
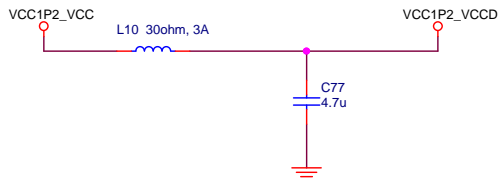

CAD Notes:
Place the 10uF cap close to ferrite bead.
Place the 0.1uF cap close to MAX10 pin.

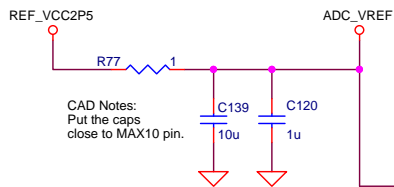

CAD Notes:
Put the caps
close to MAX10 pin.

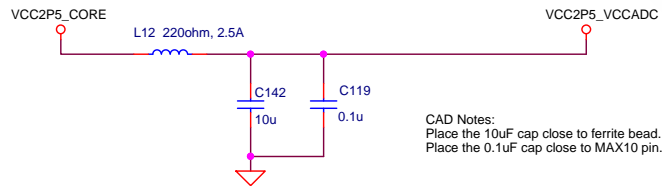
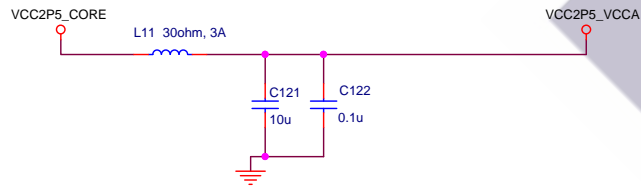

CAD Notes:
Place the 10uF cap close to ferrite bead.
Place the 0.1uF cap close to MAX10 pin.

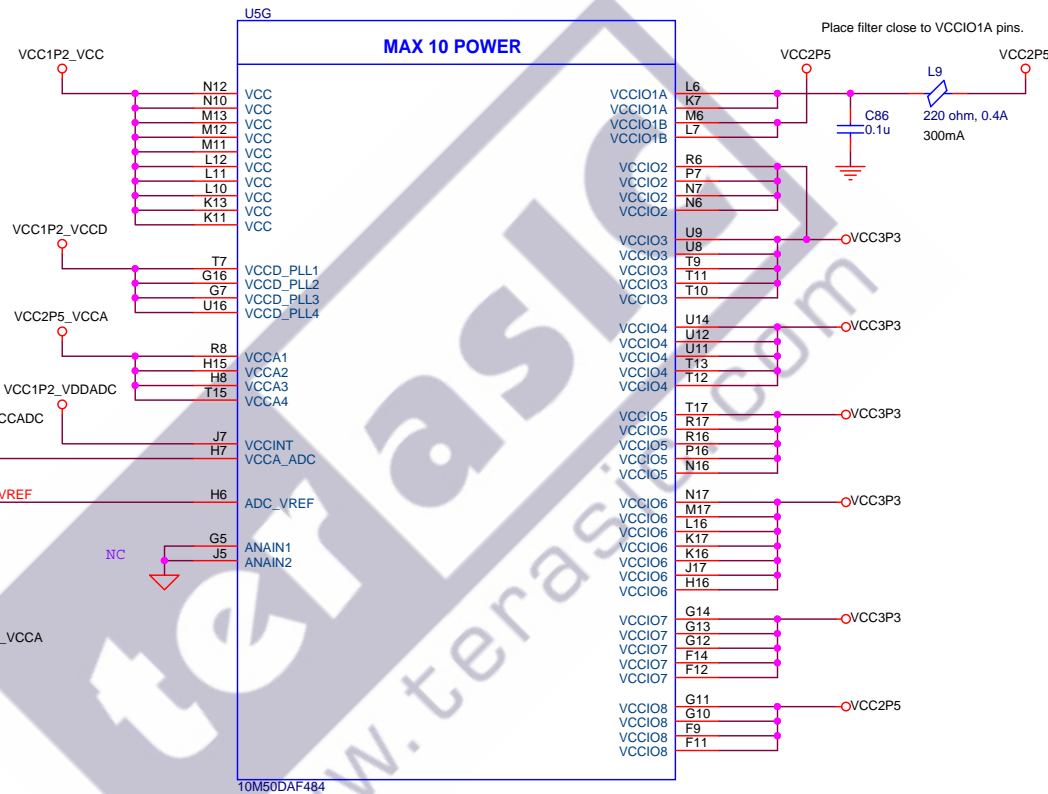

Copyright (c) 2016 by Terasic Inc. Taiwan. All rights reserved. No part of this schematic design may be reproduced, duplicated, or used without the prior written permission of Terasic.	
Title DE10-Lite	
Size B	Document Number MAX10 Power
Date: Friday, January 20, 2017	Sheet 9 of 18
Rev B1	

MAX10 Ground

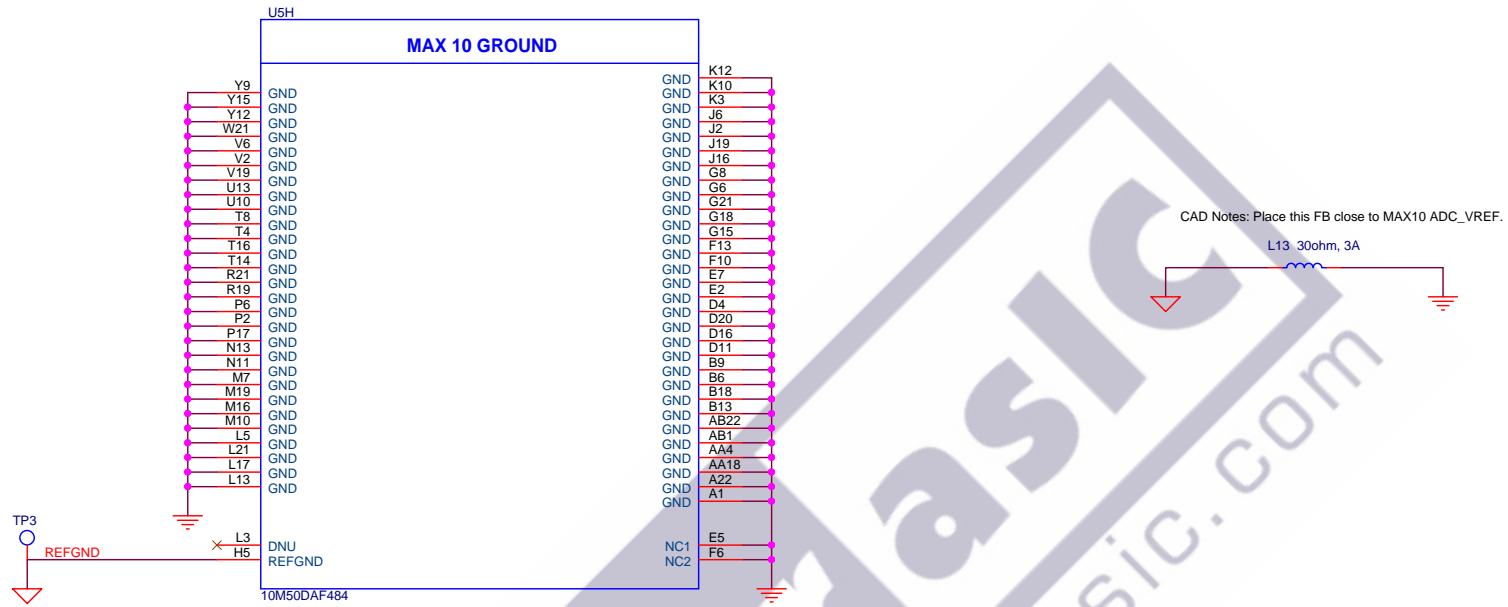

1. Use REFVDD as ground reference.
2. Route analog input signal adjacent to AVSSREF as possible.

MAX10 Decoupling

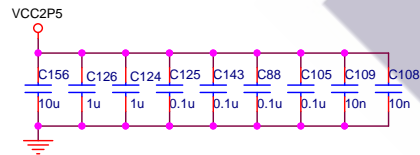
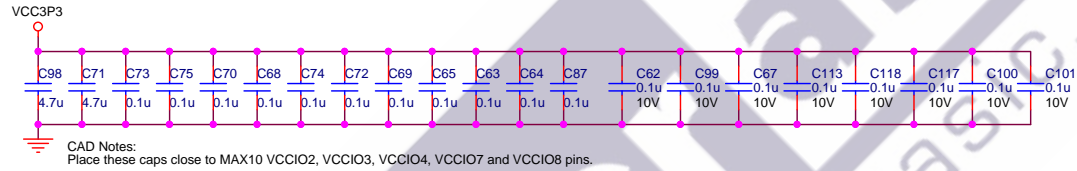
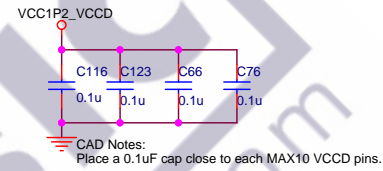
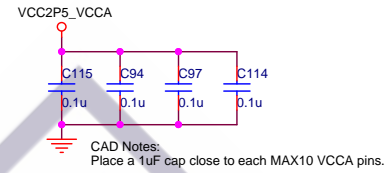
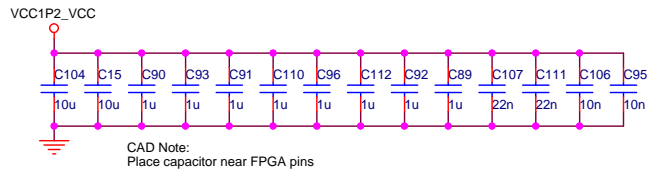

CAD Note:
Place near IC power pin

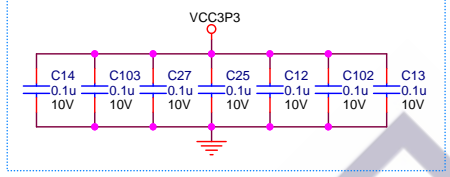

SDRAM

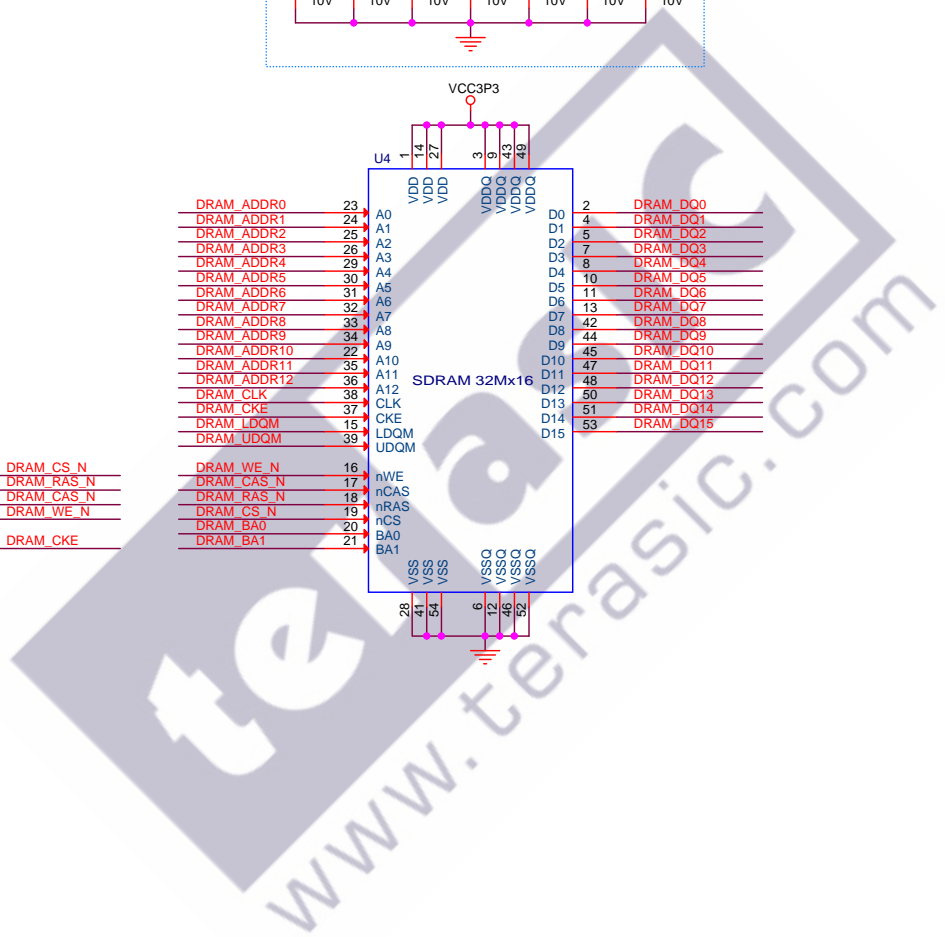
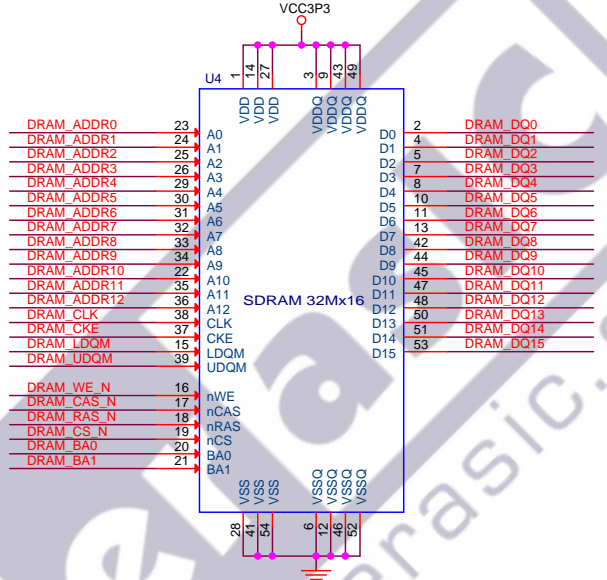
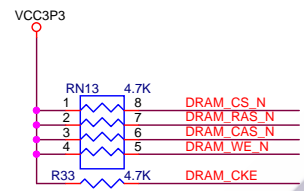
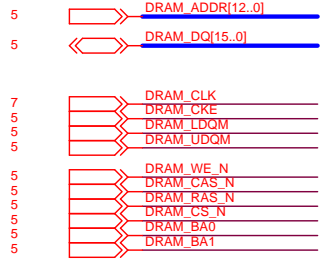

GPIO



Arduino Digital Interface



Analog input interface

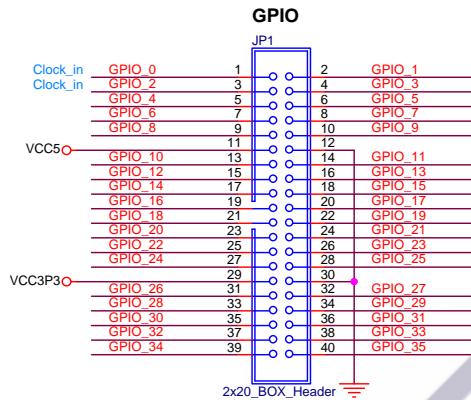

Arduino UNO Rev3

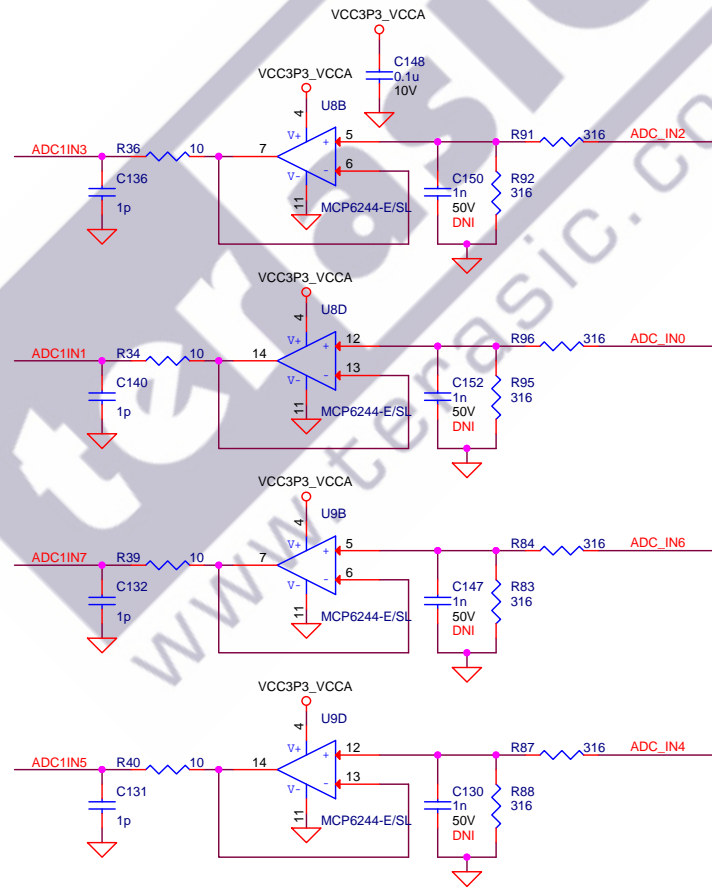
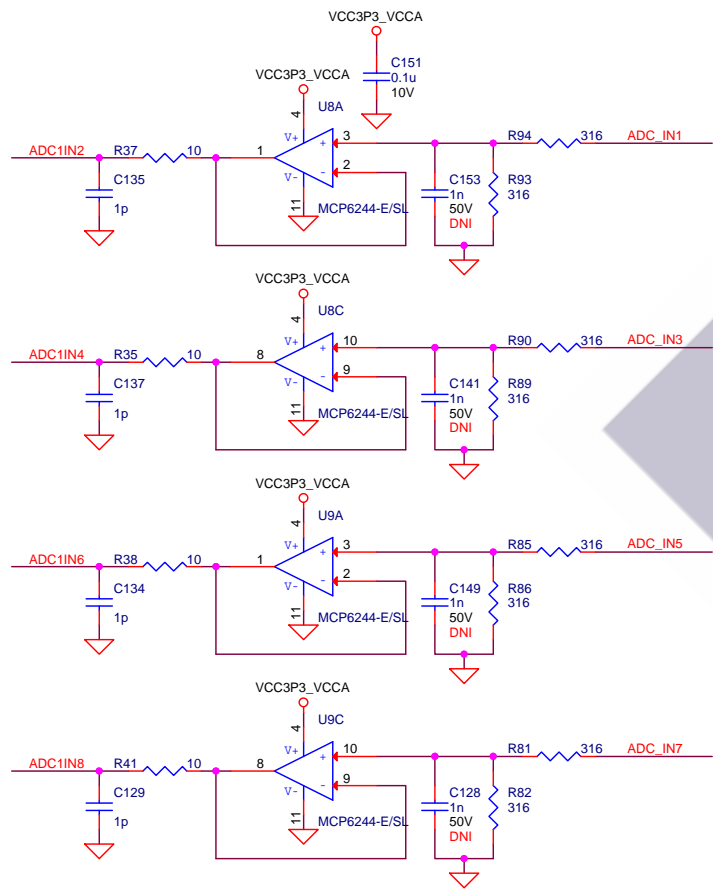
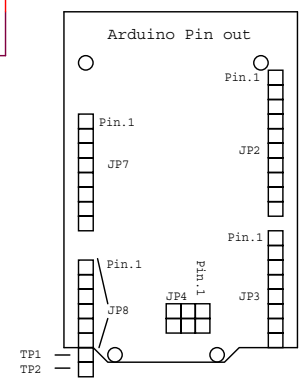
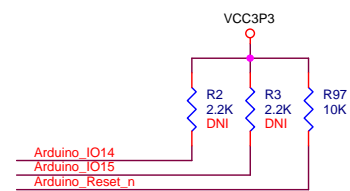
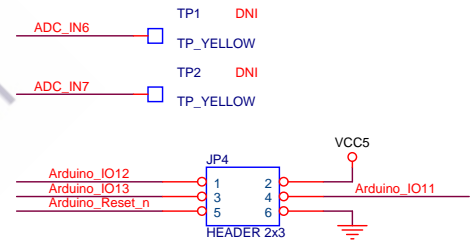
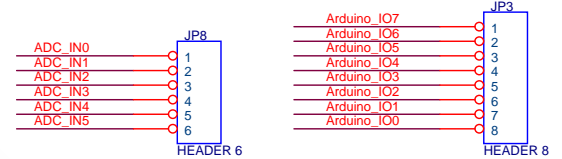
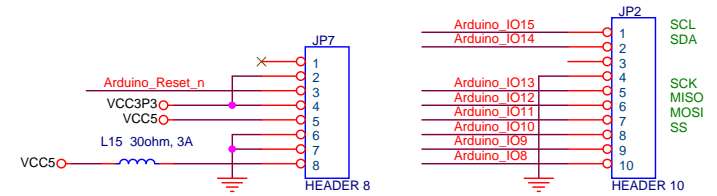

User IO, 7-Seg, LED

SWITCH

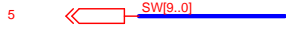

KEY



LED



7-segment Display

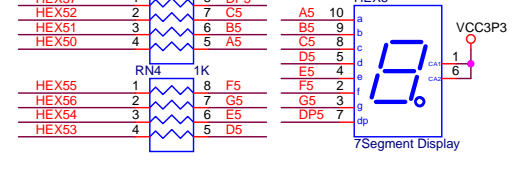
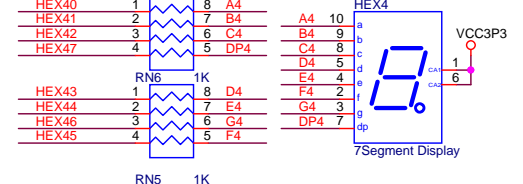
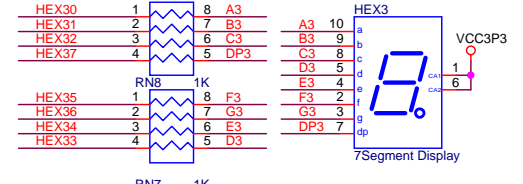
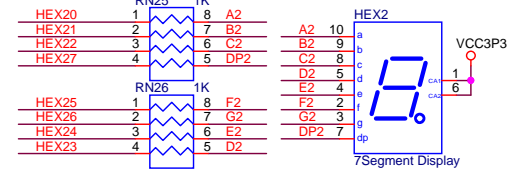
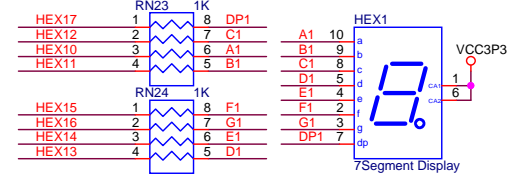
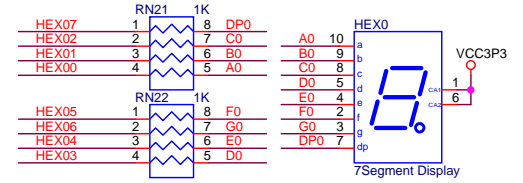
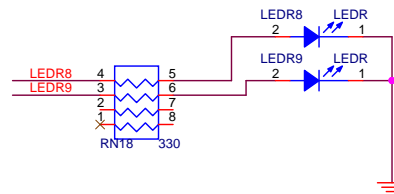
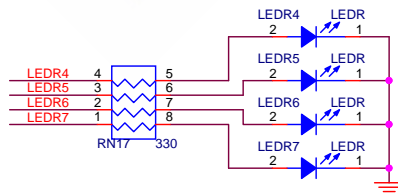
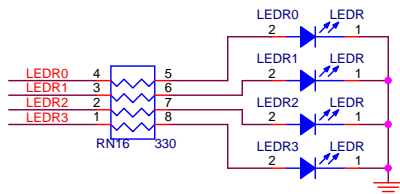
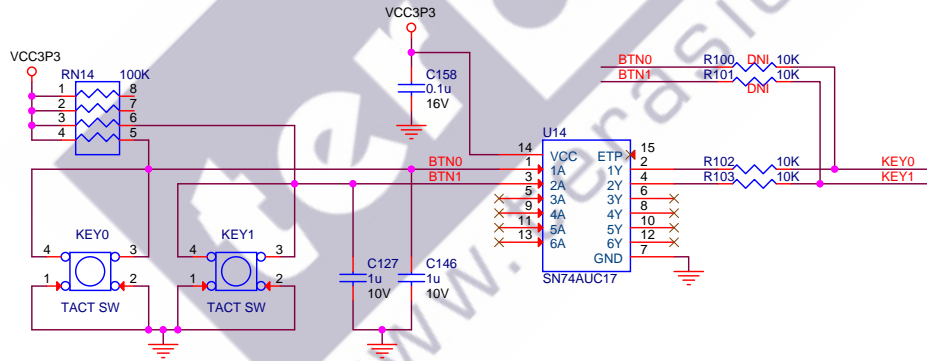
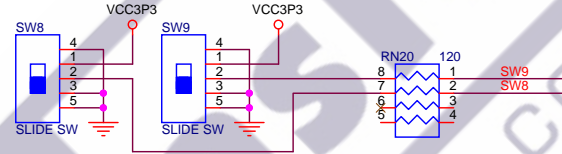
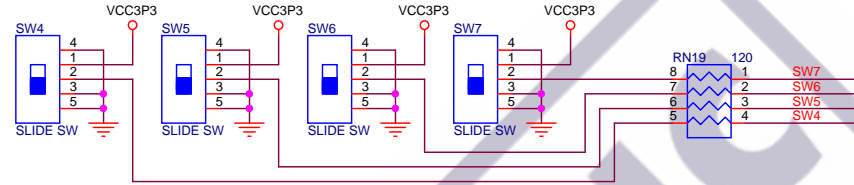
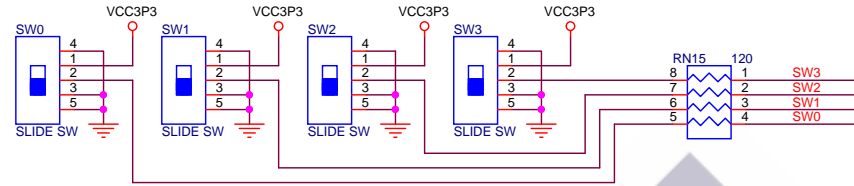

VGA

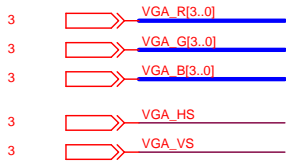

VGA and Accelerometer

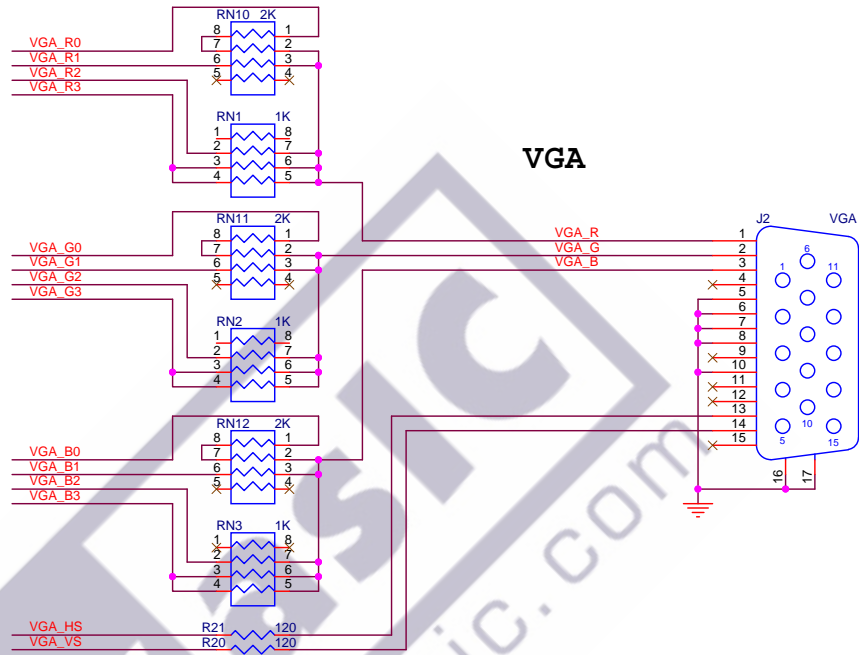

Digital Accelerometer

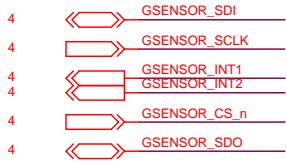

Digital Accelerometer

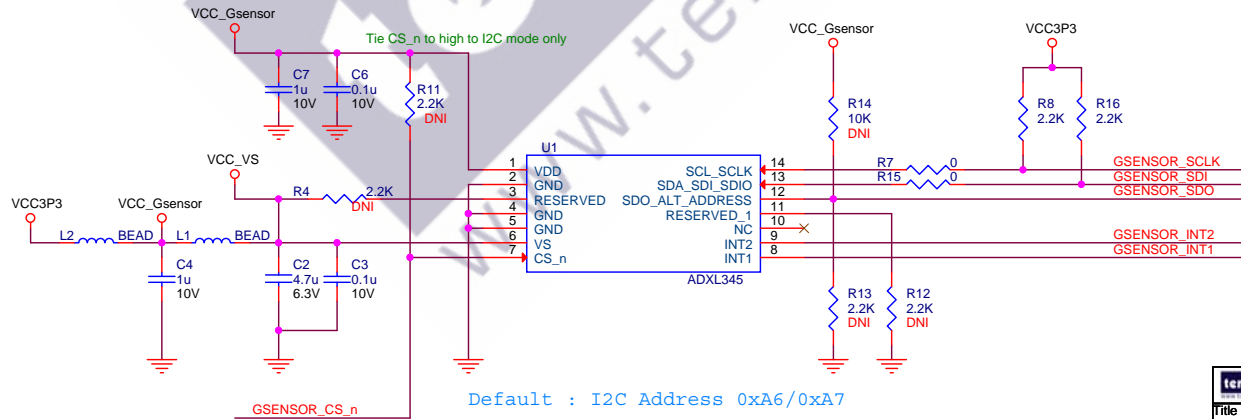

terasic Copyright (c) 2016 by Terasic Inc., Taiwan. All rights reserved. No part of this schematic design may be reproduced, duplicated, or used without the prior written permission of Terasic.

Title		
DE10-Lite		
Size	Document Number	Rev
B	VGA and Accelerometer	B1
Date:	Friday, January 20, 2017	Sheet 15 of 18

Power - 5V_DCIN / 1.2V

Power up Sequence:
 VCC5 --->
 VCC2P5, VCC3P3 --->
 VCC1P2_VCC

5V Power from USB Port

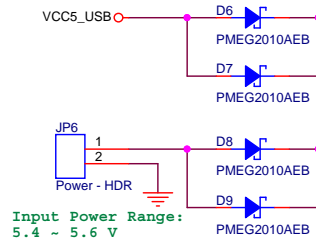

Overvoltage Protection
 Threshold Voltage : 5.4 ~ 5.6V

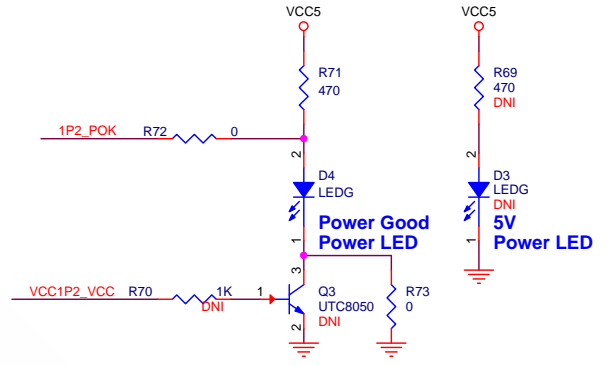
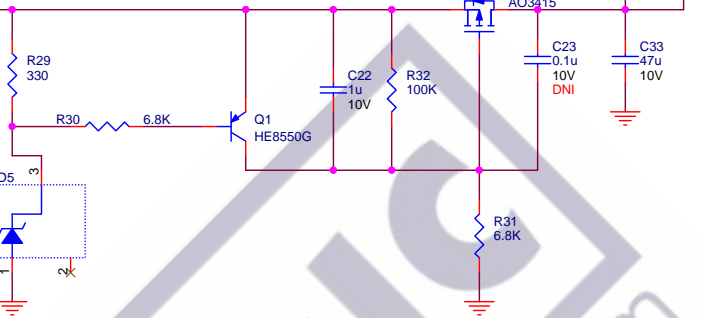

Ramp Time
 Tsoft-start = 1 msec
 Switching Frequency : 2.25MHz
 1.2V / 3A

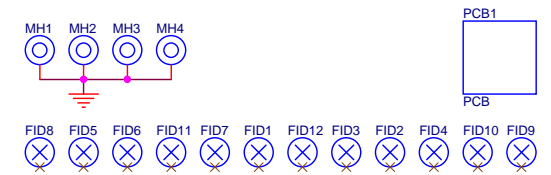
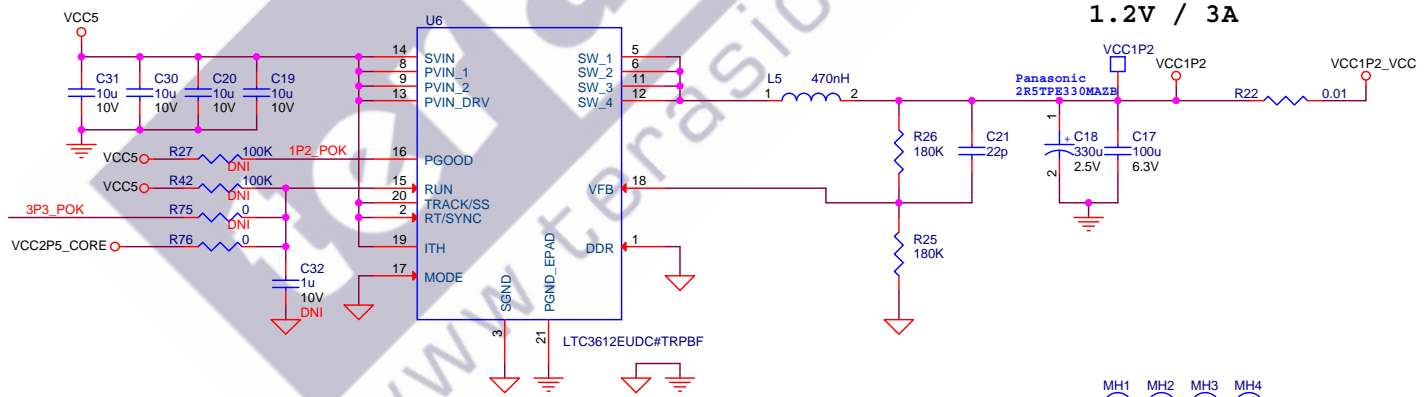

Copyright (c) 2016 by Terasic Inc. Taiwan. All rights reserved. No part of this schematic design may be reproduced, duplicated, or used without the prior written permission of Terasic.	
Title	
DE10-Lite	
Size	Document Number
B	Power - 12V, 5V
Date:	Friday, January 20, 2017
Sheet	16 of 18
Rev	B1

Power - 3.3V / 2.5V

Ramp Time
Tsoft-start = 1 msec
Switching Frequency : 2.25MHz
3.3V / 3A

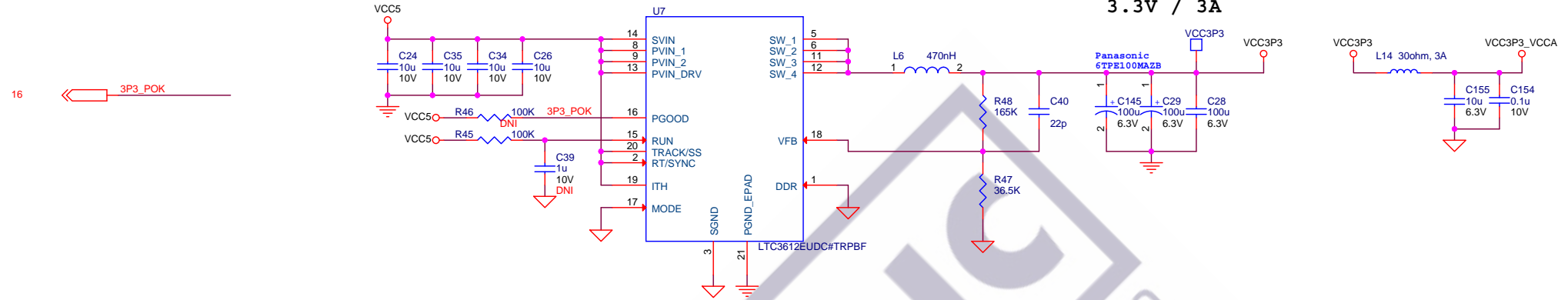

2.5V / 0.5A Ramp Time = 2 msec

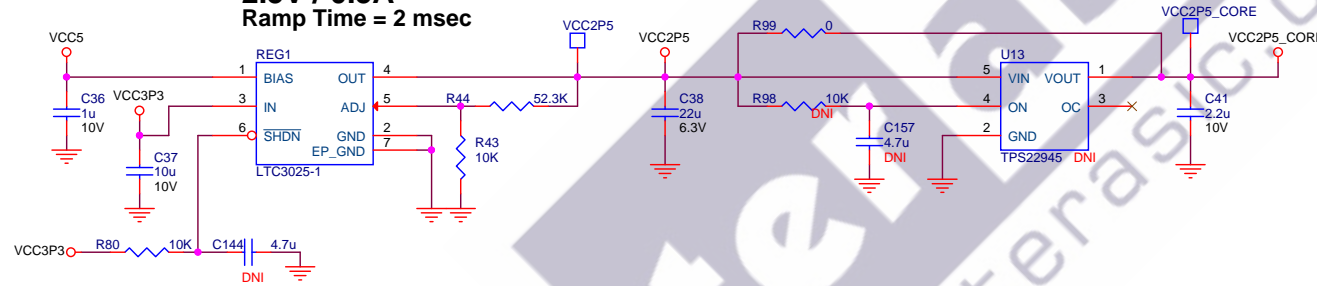

1.8V / 0.5A Ramp Time = 2 msec

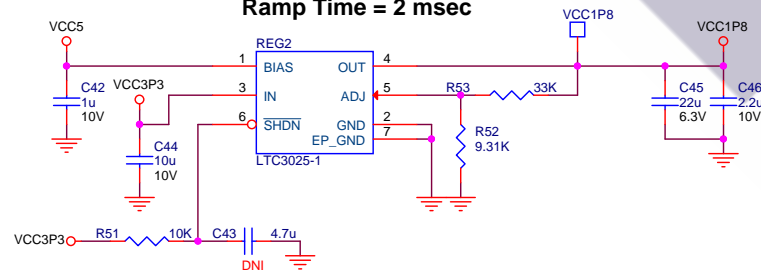

Voltage Reference

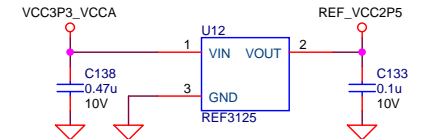

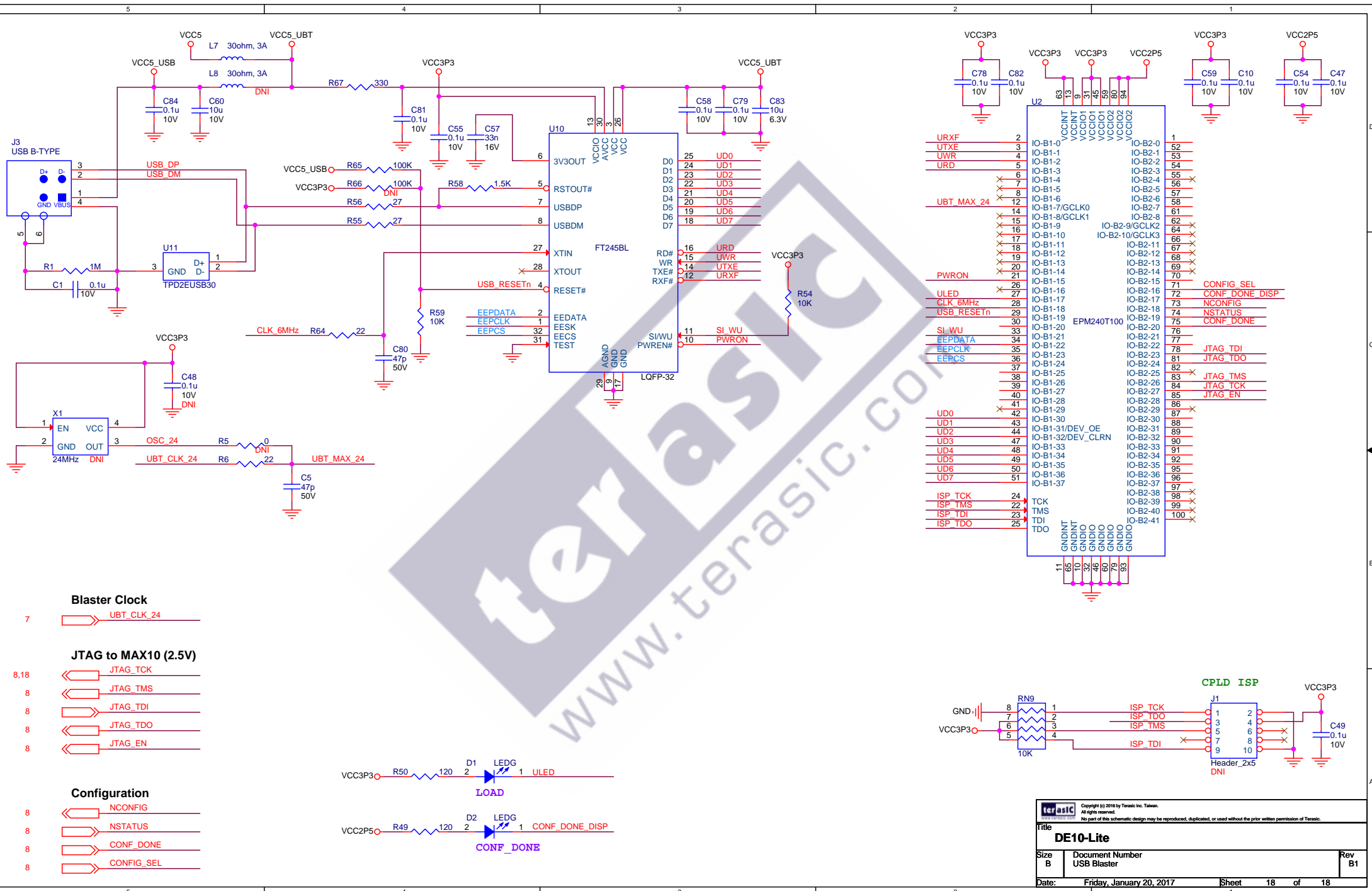

Blaster Clock



JTAG to MAX10 (2.5V)



Configuration

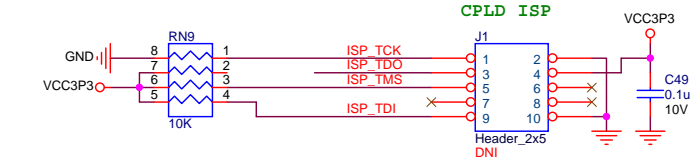
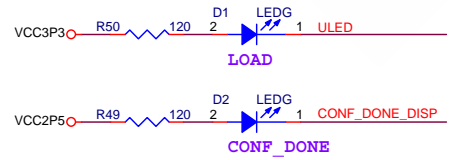
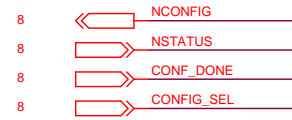

Copyright (c) 2016 by Terasic Inc. Taiwan. All rights reserved. No part of this schematic design may be reproduced, duplicated, or used without the prior written permission of Terasic.			
Title			
DE10-Lite			
Size	Document Number	Rev	
B	USB Blaster	B1	
Date:	Friday, January 20, 2017	Sheet	18 of 18