

# ***TMS320C28x CPU and Instruction Set Reference Guide***

Literature Number: SPRU430E  
August 2001 – Revised January 2009



# Read This First

---

---

---

### ***About This Manual***

This manual describes the central processing unit (CPU) and the assembly language instructions of the TMS320C28x 32-bit fixed-point CPU. It also describes emulation features available on these devices. A summary of the chapters and appendixes follows:

- |                  |   |
|------------------|---|
| <b>Chapter 1</b> | <b>Architectural Overview</b><br>This chapter introduces the C2800 CPU that is at the heart of each TMS320C28x device. The chapter includes a memory map and a high-level description of the memory interface that connects the core with memory and peripheral devices.          |
| <b>Chapter 2</b> | <b>Central Processing Unit</b><br>This chapter describes the architecture, registers, and primary functions of the CPU. The chapter includes detailed descriptions of the flag and control bits in the most important CPU registers, status registers ST0 and ST1.                |
| <b>Chapter 3</b> | <b>Interrupts and Reset</b><br>This chapter describes the interrupts and how they are handled by the CPU. The chapter also explains the effects of a reset on the CPU and includes discussion of the automatic context save performed by the CPU prior to servicing an interrupt. |
| <b>Chapter 4</b> | <b>Pipeline</b><br>This chapter describes the phases and operation of the instruction pipeline. The chapter is primarily for readers interested in increasing the efficiency of their programs by preventing pipeline delays.   |
| <b>Chapter 5</b> | <b>Addressing Modes</b><br>This chapter explains the modes by which the assembly language instructions accept data and access register and memory locations. The chapter includes a description of how addressing-mode information is encoded in opcodes.                         |
| <b>Chapter 6</b> | <b>Assembly Language Instructions</b><br>This chapter provides summaries of the instruction set and detailed descriptions (including examples) for the instructions. The chapter includes an explanation of how 32-bit accesses are aligned to even addresses.                    |

- Chapter 7**    **Emulation Features**  
This chapter describes the TMS320C28x emulation features that can be used with only a JTAG port and two additional emulation pins.
- Appendix A**    **Register Quick Reference**  
This appendix is a concise central resource for information about the status and control registers of the CPU. The chapter includes figures that summarize the bit fields of the registers.
- Appendix B**    **C2xLP and C28x Architectural Differences**  
This appendix describes the differences in the architecture of the C2xLP and the C28x.
- Appendix C**    **Migration From C2xLP**  
This appendix explains how to migrate code from the C2xLP to the C28x.
- Appendix D**    **C2xLP Instruction Set Compatibility**  
This appendix describes the instruction set compatibility with the C2xLP.
- Appendix E**    **Migration From C27x to C28x**  
This appendix explains how to migrate code from the C27x to the C28x.
- Appendix G**    **Glossary**  
This appendix explains abbreviations, acronyms, and special terminology used throughout this document.

## Notational Conventions

This document uses the following conventions:

- The device number TMS320C28x is very often abbreviated as '28x.
- Program examples are shown in a `special` typeface. Here is a sample line of program code:

```
PUSH IER
```

- Portions of an instruction syntax that are in **bold** should be entered as shown; portions of a syntax that are in *italics* are variables indicating information that should be entered. Here is an example of an instruction syntax:

**MOV AR $x$ , \*-SP[6bit]**

MOV is the instruction mnemonic. This instruction has two operands, indicated by **AR $x$**  and **\*-SP[6bit]**. Where the variable  $x$  appears, you type a value from 0 to 5; where the *6bit* appears, you type a 6-bit constant. The rest of the instruction, including the square brackets, must be entered as shown.

- When braces or brackets enclose an operand, as in {operand}, the operand is optional. If you use an optional operand, you specify the information within the braces; you do not enter the braces themselves. In the following syntax, the operand `<< shift` is optional:

**MOV ACC, \*-SP[6bit] {<< shift }**

**MOV ACC, \*-SP{6bit} {<< shift }**

For example, you could use either of the following instructions:

```
MOV ACC, *-SP[5]
```

```
MOV ACC, *-SP[5] << 4
```

- In most cases, hexadecimal numbers are shown with a subscript of 16. For example, the hexadecimal number 40 would be shown as 40<sub>16</sub>. An exception to this rule is a hexadecimal number in a code example; these hexadecimal numbers have the suffix `h`. For example, the number 40 in the following code is a hexadecimal 40.

```
MOVB AR0, #40h
```

Similarly, binary numbers usually are shown with a subscript of 2. For example, the binary number 4 would be shown as 0100<sub>2</sub>. Binary numbers in example code have the suffix b. For example, the following code uses a binary 4.

```
MOVB AR0, #0100b
```

- Bus signals and bits are sometimes represented with the following notations:

Notation	Description	Example
Bus(n:m)	Signals n through m of bus	PRDB(31:0) represents the 32 signals of the program-read data bus (PRDB).
Register(n:m)	Bits n through m of register	T(3:0) represents the 4 least significant bits of the T register.
Register(n)	Bit n of register	IER(4) represents bit 4 of the interrupt enable register (IER).

- Concatenated values are represented with the following notation:

Notation	Description	Example
x:y	x concatenated with y	AR1:AR0 is the concatenation of the 16-bit registers AR1 and AR0. AR0 is the low word. AR1 is the high word.

- If a signal is from an active-low pin, the name of the signal is qualified with an overbar (for example,  $\overline{\text{INT1}}$ ). If a signal is from an active-high pin or from hardware inside the the device (in which case, the polarity is irrelevant), the name of the signal is left unqualified (for example, DLOGINT).

## **Related Documentation From Texas Instruments**

The following books describe the TMS320C28x DSP and related support tools. The documents are available for downloading on the Texas Instruments website ([www.ti.com](http://www.ti.com)).

**TMS320F2801, TMS320F2806, TMS320F2808 Digital Signal Processors** (literature number SPRS230) data sheet contains the pinout, signal descriptions, as well as electrical and timing specifications for the F280x devices.

**TMS320C28x Assembly Language Tools User's Guide** (literature number SPRU513) describes the assembly language tools (assembler and other tools used to develop assembly language code), assembler directives, macros, common object file format, and symbolic debugging directives for the TMS320C28x™ device.

**TMS320C28x Optimizing C Compiler User's Guide** (literature number SPRU514) describes the TMS320C28x™ C/C++ compiler. This compiler accepts ANSI standard C/C++ source code and produces TMS320™ DSP assembly language source code for the TMS320C28x device.

**TMS320F2810, TMS320F2811, TMS320F2812, TMS320C2810, TMS320C2811, and TMS320C2812 Digital Signal Processors** (literature number SPRS174) data sheet contains the electrical and timing specifications for these devices, as well as signal descriptions and pinouts for all of the available packages.

**TMS320x28xx, 28xxx DSP Peripherals Reference Guide** (literature number SPRU566) describes all the peripherals available for TMS320x28xx and TMS320x28xxx devices.

**TMS320C28x Floating Point Unit and Instruction Set Reference Guide** (literature number SPRUEO2) describes the CPU architecture, pipeline, instruction set, and interrupts of the C28x floating-point DSP.

***Trademarks***

320 Hotline On-line is a trademark of Texas Instruments Incorporated.

HP-UX is a trademark of Hewlett-Packard Company.

IBM and PC are trademarks of International Business Machines Corporation.

Intel is a trademark of Intel Corporation.

MS-DOS is a registered trademark of Microsoft Corporation.

PAL<sup>®</sup> is a registered trademark of Advanced Micro Devices, Inc.

SunOS is a trademark of Sun Microsystems, Inc.

C2xLP, C27x, C28x, TMS320C28x, TMS320F28x, and XDS510 are trademarks of Texas Instruments Incorporated.

# Contents

---

---

---

<b>1</b>	<b>Architectural Overview</b> .....	<b>1-1</b>
	<i>Introduces the architecture and memory map of the T320C28x DSP CPU.</i>	
1.1	Introduction to the CPU .....	1-2
1.1.1	Compatibility With Other TMS320 CPUs .....	1-2
1.1.2	Switching to C28x Mode From Reset .....	1-3
1.2	Components of the CPU .....	1-4
1.2.1	Central Processing Unit (CPU) .....	1-4
1.2.2	Emulation Logic .....	1-5
1.2.3	Signals .....	1-6
1.3	Memory Map .....	1-7
1.3.1	CPU Interrupt Vectors .....	1-7
1.4	Memory Interface .....	1-9
1.4.1	Address and Data Buses .....	1-9
1.4.2	Special Bus Operations .....	1-10
1.4.3	Alignment of 32-Bit Accesses to Even Addresses .....	1-11
<b>2</b>	<b>Central Processing Unit</b> .....	<b>2-1</b>
	<i>Describes the architecture, registers, and primary functions of the TMS320C28x CPU.</i>	
2.1	CPU Architecture .....	2-2
2.2	CPU Registers .....	2-4
2.2.1	Accumulator (ACC, AH, AL) .....	2-6
2.2.2	Multiplicand Register (XT) .....	2-8
2.2.3	Product Register (P, PH, PL) .....	2-9
2.2.4	Data Page Pointer (DP) .....	2-10
2.2.5	Stack Pointer (SP) .....	2-11
2.2.6	Auxiliary Registers (XAR0–XAR7, AR0–AR7) .....	2-12
2.2.7	Program Counter (PC) .....	2-14
2.2.8	Return Program Counter (RPC) .....	2-14
2.2.9	Status Registers (ST0, ST1) .....	2-14
2.2.10	Interrupt-Control Registers (IFR, IER, DBGIER) .....	2-14
2.3	Status Register (ST0) .....	2-16
2.4	Status Register ST1 .....	2-34
2.5	Program Flow .....	2-39
2.5.1	Interrupts .....	2-39
2.5.2	Branches, Calls, and Returns .....	2-39



2.5.3	Repeating a Single Instruction .....	2-39
2.5.4	Instruction Pipeline .....	2-40
2.6	Multiply Operations .....	2-41
2.6.1	16-bit X 16-bit Multiplication .....	2-41
2.6.2	32-Bit X 32-Bit Multiplication .....	2-42
2.7	Shift Operations .....	2-44
<b>3</b>	<b>CPU Interrupts and Reset .....</b>	<b>3-1</b>
	<i>Describes the TMS320C28x interrupts and how they are handled by the CPU. Also explains the effects of a hardware reset.</i>	
3.1	CPU Interrupts Overview .....	3-2
3.2	CPU Interrupt Vectors and Priorities .....	3-4
3.3	Maskable Interrupts: INT1–INT14, DLOGINT, and RTOSINT .....	3-6
3.3.1	CPU Interrupt Flag Register (IFR) .....	3-7
3.3.2	CPU Interrupt Enable Register (IER) and CPU Debug Interrupt Enable Register (DBGIER) .....	3-8
3.4	Standard Operation for Maskable Interrupts .....	3-11
3.5	Nonmaskable Interrupts .....	3-17
3.5.1	INTR Instruction .....	3-17
3.5.2	TRAP Instruction .....	3-18
3.5.3	Hardware Interrupt NMI .....	3-21
3.6	Illegal-Instruction Trap .....	3-22
3.7	Hardware Reset (RS) .....	3-23
<b>4</b>	<b>Pipeline .....</b>	<b>4-1</b>
	<i>Describes the phases and operation of the instruction pipeline.</i>	
4.1	Pipelining of Instructions .....	4-2
4.1.1	Decoupled Pipeline Segments .....	4-4
4.1.2	Instruction-Fetch Mechanism .....	4-4
4.1.3	Address Counters FC, IC, and PC .....	4-5
4.2	Visualizing Pipeline Activity .....	4-7
4.3	Freezes in Pipeline Activity .....	4-10
4.3.1	Wait States .....	4-10
4.3.2	Instruction-Not-Available Condition .....	4-10
4.4	Pipeline Protection .....	4-12
4.4.1	Protection During Reads and Writes to the Same Data-Space Location .....	4-12
4.4.2	Protection Against Register Conflicts .....	4-13
4.5	Avoiding Unprotected Operations .....	4-16
4.5.1	Unprotected Program-Space Reads and Writes .....	4-16
4.5.2	An Access to One Location That Affects Another Location .....	4-16
4.5.3	Write Followed By Read Protection Mode .....	4-17

<b>5</b>	<b>C28x Addressing Modes</b> .....	<b>5-1</b>
	<i>Describes the addressing modes of the C28x.</i>	
5.1	Types of Addressing Modes .....	5-2
5.2	Addressing Modes Select Bit (AMODE) .....	5-4
5.3	Assembler/Compiler Tracking of AMODE Bit .....	5-7
5.4	Direct Addressing Modes (DP) .....	5-8
5.5	Stack Addressing Modes (SP) .....	5-9
5.6	Indirect Addressing Modes .....	5-10
5.6.1	C28x Indirect Addressing Modes (XAR0 to XAR7) .....	5-10
5.6.2	C2xLP Indirect Addressing Modes (ARP, XAR0 to XAR7) .....	5-12
5.6.3	Circular Indirect Addressing Modes (XAR6, XAR1) .....	5-21
5.7	Register Addressing Modes .....	5-25
5.7.1	32-Bit Register Addressing Modes .....	5-25
5.7.2	16-Bit Register Addressing Modes .....	5-26
5.8	Data/Program/IO Space Immediate Addressing Modes .....	5-28
5.9	Program Space Indirect Addressing Modes .....	5-30
5.10	Byte Addressing Modes .....	5-31
5.11	Alignment of 32-Bit Operations .....	5-33
<b>6</b>	<b>C28x Assembly Language Instructions</b> .....	<b>6-1</b>
	<i>Presents summaries of the instruction set, defines special symbols and notations used, and describes each instruction in detail in alphabetical order.</i>	
6.1	Instruction Set Summary (Organized by Function) .....	6-2
6.2	Register Operations .....	6-4
<b>7</b>	<b>Emulation Features</b> .....	<b>7-1</b>
	<i>Explains features supported by the TC2800 CPU for testing and debugging programs.</i>	
7.1	Overview of Emulation Features .....	7-2
7.2	Debug Interface .....	7-3
7.3	Debug Terminology .....	7-6
7.4	Execution Control Modes .....	7-7
7.4.1	Stop Mode .....	7-7
7.4.2	Real-Time Mode .....	7-9
	Caution about breakpoints within time-critical interrupt service routines ....	7-11
7.4.3	Summary of Stop Mode and Real-Time Mode .....	7-11
7.5	Aborting Interrupts With the ABORTI Instruction .....	7-15
7.6	DT-DMA Mechanism .....	7-16
7.7	Analysis Breakpoints, Watchpoints, and Counter(s) .....	7-19
7.7.1	Analysis Breakpoints .....	7-19
7.7.2	Watchpoints .....	7-19
7.7.3	Benchmark Counter/Event Counter(s) .....	7-20
7.7.4	Typical Analysis Unit Configurations .....	7-21

7.8	Data Logging .....	7-23
7.8.1	Creating a Data Logging Transfer Buffer .....	7-23
7.8.2	Accessing the Emulation Registers Properly .....	7-26
7.8.3	Data Log Interrupt (DLOGINT) .....	7-27
7.8.4	Examples of Data Logging .....	7-28
7.9	Sharing Analysis Resources .....	7-30
7.10	Diagnostics and Recovery .....	7-31
<b>A</b>	<b>Register Quick Reference .....</b>	<b>A-1</b>
	<i>Is a concise, central resource for information about the status and control registers of the TMS320C28x CPU.</i>	
A.1	Reset Values of and Instructions for Accessing the Registers .....	A-2
A.2	Register Figures .....	A-3
<b>B</b>	<b>C2xLP and C28x Architectural Differences .....</b>	<b>B-1</b>
	<i>Highlights some the architectural differences between C2xLP and C28x, with a focus on registers and memory maps.</i>	
FB.1	Summary of Architecture Differences Between C2xLP and C28x .....	B-2
B.1.1	Enhancements of the C28x over the C2xLP: .....	B-2
B.2	Registers .....	B-3
B.2.1	CPU Register Changes .....	B-4
B.2.2	Data Page (DP) Pointer Changes .....	B-5
B.2.3	Status Register Changes .....	B-7
B.2.4	Register Reset Conditions .....	B-10
B.3	Memory Map .....	B-12
<b>C</b>	<b>C2xLP Migration Guidelines .....</b>	<b>C-1</b>
	<i>Provides guidelines for C2xLP code migration to a C28x device.</i>	
C.1	Introduction .....	C-2
C.2	Recommended Migration Flow .....	C-3
C.3	Mixing C2xLP and C28x Assembly .....	C-6
C.4	Code Examples .....	C-7
C.4.1	Boot Code for C28x operating mode initialization .....	C-7
C.4.2	IER/IFR Code .....	C-7
C.4.3	Context Save/Restore .....	C-8
C.5	Reference Tables for C2xLP Code Migration Topics .....	C-10
<b>D</b>	<b>C2xLP Instruction Set Compatibility .....</b>	<b>D-1</b>
	<i>Describes the instruction set compatibility between the C2xLP and the C28x.</i>	
D.1	Condition Tests on Flags .....	D-2
D.2	C2xLP vs. C28x Mnemonics .....	D-3
D.3	Repeatable Instructions .....	D-9

<b>E</b>	<b>Migration From C27x to C28x</b> .....	<b>E-1</b>
	<i>Highlights the architectural differences between C27x and C28x and describes how to migrate your code from C27x to C28x</i>	
E.1	Architecture Changes .....	E-2
E.1.1	Changes to Registers .....	E-2
E.1.2	Full Context Save and Restore .....	E-5
E.1.3	B0/B1 Memory Map Consideration .....	E-6
E.1.4	C27x Object Compatibility .....	E-8
E.2	Moving to a C28x Object .....	E-9
E.2.1	Caution When Changing OJBMODE .....	E-9
E.3	Migrating to C28x Object Code .....	E-11
E.3.1	Instruction Syntax Changes .....	E-11
E.3.2	Repeatable Instructions .....	E-13
E.3.3	Changes to the SUBCU Instruction .....	E-14
E.4	Compiling C28x Source Code .....	E-16
<b>F</b>	<b>Glossary</b> .....	<b>G-1</b>

# Figures

---

---

---

1-1	High-Level Conceptual Diagram of the CPU	1-4
1-2	TMS320C28x High-Level Memory Map	1-8
2-1	Conceptual Block Diagram of the CPU	2-3
2-2	C28x Registers	2-6
2-3	Individually Accessible Portions of the Accumulator	2-7
2-4	Individually Accessible Halves of the XT Register	2-9
2-5	Individually Accessible Halves of the P Register	2-9
2-6	Pages of Data Memory	2-11
2-7	Address Reach of the Stack Pointer	2-12
2-8	XAR0 – XAR7 Registers	2-13
2-9	XAR0 – XAR7	2-13
2-10	Bit Fields of Status Register (ST0)	2-16
2-11	Bit Fields of Status Register 1 (ST1)	2-34
2-12	Conceptual Diagram of Components Involved in 16 X16-Bit Multiplication	2-42
2-13	Conceptual Diagram of Components Involved in 32 X 32-Bit Multiplication	2-43
3-1	Interrupt Flag Register (IFR)	3-7
3-2	Interrupt Enable Register (IER)	3-9
3-3	Debug Interrupt Enable Register (DBGIER)	3-10
3-4	Standard Operation for CPU Maskable Interrupts	3-12
3-5	Functional Flow Chart for an Interrupt Initiated by the TRAP Instruction	3-18
5-1	Circular Buffer with AMODE = 0	5-22
5-2	Circular Buffer with AMODE = 1	5-24
7-1	JTAG Header to Interface a Target to the Scan Controller	7-3
7-2	Stop Mode Execution States	7-8
7-3	Real-time Mode Execution States	7-10
7-4	Stop Mode Versus Real-Time Mode	7-12
7-5	Process for Handling a DT-DMA Request	7-17
7-6	ADDRL (at Data-Space Address 00 083816)	7-24
7-7	ADDRH (at Data-Space Address 00 083916)	7-24
7-8	REFL (at Data-Space Address 00 084A16)	7-24
7-9	REFH (at Data-Space Address 00 084B16)	7-24
7-10	Valid Combinations of Analysis Resources	7-30
A-1	Status register ST0	A-4
A-2	Status register ST1, Bits15–8	A-5
A-3	Status Register ST1, Bits 7–0	A-6
A-4	Interrupt flag register (IFR)	A-7

A-5	Interrupt enable register (IER) .....	A-8
A-6	Debug interrupt enable register (DBGIER) .....	A-9
B-1	Register Changes From C2xLP to C28x .....	B-3
B-2	Direct Addressing Mode Mapping .....	B-6
B-3	Status Register Comparison Between C2xLP and C28x .....	B-7
B-4	Memory Map Comparison (See Note A) .....	B-13
C-1	Flow Chart of Recommended Migration Steps .....	C-4
E-1	C28x Registers .....	E-2
E-2	Full Context Save/Restore .....	E-5
E-3	Code for a Full Context Save/Restore for C28x vs C27x .....	E-6
E-4	Mapping of Memory Blocks B0 and B1 on C27x .....	E-7
E-5	C27x Compatible Mapping of Blocks M0 and M1 .....	E-7
E-6	Building a C27x Object File From C27x Source .....	E-8
E-7	Building a C28x Object File From Mixed C27x/C28x Source .....	E-9
E-8	Compiling C28x Source .....	E-16

# Tables

1-1	Compatibility Modes .....	1-2
1-2	Summary of Bus Use During Data-Space and Program-Space Accesses .....	1-10
1-3	Special Bus Operations .....	1-11
2-1	CPU Register Summary .....	2-4
2-2	Available Operations for Shifting Values in the Accumulator .....	2-8
2-3	Product Shift Modes .....	2-10
2-4	Instructions That Affect OVC/OVCU .....	2-17
2-5	Instructions Affected by the PM Bits .....	2-20
2-6	Instructions Affected by V flag .....	2-21
2-7	Negative Flag Under Overflow Conditions .....	2-24
2-8	Bits Affected by the C Bit .....	2-25
2-9	Instructions That Affect the TC Bit .....	2-31
2-10	Instructions Affected by SXM .....	2-33
2-11	Shift Operations .....	2-45
3-1	Interrupt Vectors and Priorities .....	3-4
3-2	Requirements for Enabling a Maskable Interrupt .....	3-7
3-3	Register Pairs Saved and SP Positions for Context Saves .....	3-14
3-4	Register Pairs Saved and SP Positions for Context Saves .....	3-20
3-5	Registers After Reset .....	3-23
5-1	Addressing Modes for “loc16” or “loc32” .....	5-4
6-1	Instruction Set Summary (Organized by Function) .....	6-2
6-2	Register Operations .....	6-4
7-1	14-Pin Header Signal Descriptions .....	7-4
7-2	Selecting Device Operating Modes By Using TRST, EMU0, and EMU1 .....	7-5
7-3	Interrupt Handling Information By Mode and State .....	7-13
7-4	Start Address and DMA Registers .....	7-25
7-5	End-Address Registers .....	7-26
7-6	Analysis Resources .....	7-30
A-1	Reset Values of the Status and Control Registers .....	A-2
B-1	General Features .....	B-2
B-2	C2xLP Product Mode Shifter .....	B-8
B-3	C28x Product Mode Shifter .....	B-8
B-4	Reset Conditions of Internal Registers .....	B-10
B-5	Status Register Bits .....	B-11
B-6	B0 Memory Map .....	B-14
C-1	Code to Save Contents Of IMR (IER) And Disabling Lower Priority Interrupts At Beginning Of ISR .....	C-7

---

C-2	Code to Disable an Interrupt .....	C-7
C-3	Code to Enable an Interrupt .....	C-8
C-4	Code to Clear the IFR Register .....	C-8
C-5	Full Context Save/Restore Comparison .....	C-9
C-6	C2xLP and C28x Differences in Interrupts .....	C-10
C-7	C2xLP and C28x Differences in Status Registers .....	C-11
C-8	C2xLP and C28x Differences in Memory Maps .....	C-12
C-9	C2xLP and C28x Differences in Instructions and Registers .....	C-13
C-10	Code Generation Tools and Syntax Differences .....	C-15
D-1	C28x and C2xLP Flags .....	D-2
D-2	C2xLP Instructions and C28x Equivalent Instructions .....	D-3
D-3	Repeatable Instructions for the C2xLP and C28x .....	D-9
E-1	ST0 Register Bits .....	E-3
E-2	ST1 Register Bits .....	E-4
E-3	Instruction Syntax Change .....	E-12



# Examples

---

---

---

3-1	Typical ISR .....	3-16
4-1	Relationship Between Pipeline and Address Counters FC, IC, and PC .....	4-6
4-2	Diagramming Pipeline Activity .....	4-8
4-3	Simplified Diagram of Pipeline Activity .....	4-9
4-4	Conflict Between a Read From and a Write to Same Memory Location .....	4-13
4-5	Register Conflict .....	4-14
7-1	Initialization Code for Data Logging With Word Counter .....	7-28
7-2	Initialization Code for Data Logging With End Address .....	7-29

# Architectural Overview

---

---

---

---

The TMS320C28x™ is one of several fixed-point CPUs in the TMS320 family. The C28x™ is source-code and object-code compatible with the C27x™. In addition, much of the code written for the C2xLP CPU can be reassembled to run on a C28x device.

The C2xLP CPU is used in all TMS320F24xx and TMS320C20x devices and their derivatives. This document refers to C2xLP as a generic name for the CPU used in these devices.

This chapter provides an overview of the architectural structure and components of the C28x CPU.

<b>Topic</b>	<b>Page</b>
<b>1.1 Introduction to the CPU</b> .....	<b>1-2</b>
<b>1.2 Components of the CPU</b> .....	<b>1-4</b>
<b>1.3 Memory Map</b> .....	<b>1-7</b>
<b>1.4 Memory Interface</b> .....	<b>1-9</b>

## 1.1 Introduction to the CPU

The CPU is a low-cost 32-bit fixed-point processor. This device draws from the best features of digital signal processing; reduced instruction set computing (RISC); and microcontroller architectures, firmware, and tool sets. The CPU features include a modified Harvard architecture and circular addressing. The RISC features are single-cycle instruction execution, register-to-register operations, and modified Harvard architecture (usable in Von Neumann mode). The microcontroller features include ease of use through an intuitive instruction set, byte packing and unpacking, and bit manipulation.

The modified Harvard architecture of the CPU enables instruction and data fetches to be performed in parallel. The CPU can read instructions and data while it writes data simultaneously to maintain the single-cycle instruction operation across the pipeline. The CPU does this over six separate address/data buses.

### 1.1.1 Compatibility With Other TMS320 CPUs

The C28x CPU features compatibility modes that minimize the migration effort from the C27x and C2xLP CPUs. The operating mode of the device is determined by a combination of the OBJMODE and AMODE bits in status register 1 (ST1) as shown in Table 1–1. The OBJMODE bit allows you to select between code compiled for a C28x (OBJMODE == 1) and code compiled for a C27x (OBJMODE == 0). The AMODE bit allows you to select between C28x/C27x instruction addressing modes (AMODE == 0) and C2xLP compatible instruction addressing modes (AMODE == 1).

Table 1–1. Compatibility Modes

	OBJMODE	AMODE
C28x Mode	1	0
C2xLP Source-compatible Mode	1	1
C27x Object-compatible Mode <sup>†</sup>	0	0

<sup>†</sup> The C28x is in C27x-compatible mode at reset.

- C28x Mode: In C28x mode, you can take advantage of all the C28x native features, addressing modes, and instructions. To operate in C28x mode from reset, your code must first set the OBJMODE bit by using the "C28OBJ" (or "SETC OBJMODE") instruction. This book assumes you are operating in C28x mode unless stated otherwise.

- ❑ **C2xLP Source-Compatible Mode:** C2xLP source-compatible mode allows you to run C2xLP source code which has been reassembled using the C28x code-generation tools. For more information on operating in this mode and migration from a C2xLP CPU, see Appendices C, D, and E.
- ❑ **C27x Object-Compatible Mode:** At reset, the C28x CPU operates in C27x object-compatible mode. In this mode, the C28x is 100% object-code and cycle-count compatible with the C27x CPU. For detailed information on operating in C27x object-compatible mode and migrating from the C27x, see Appendix F.

### 1.1.2 Switching to C28x Mode From Reset

At reset, the C28x CPU is in C27x Object-Compatible Mode (OBJMODE == 0, AMODE == 0) and is 100% compatible with the C27x CPU. To take advantage of the enhanced C28x instruction set, you must instead operate the device in C28x mode. To do this, after a reset your code must first set the OBJMODE bit in ST1 by using the "C28OBJ" (or "SETC OBJMODE") instruction.

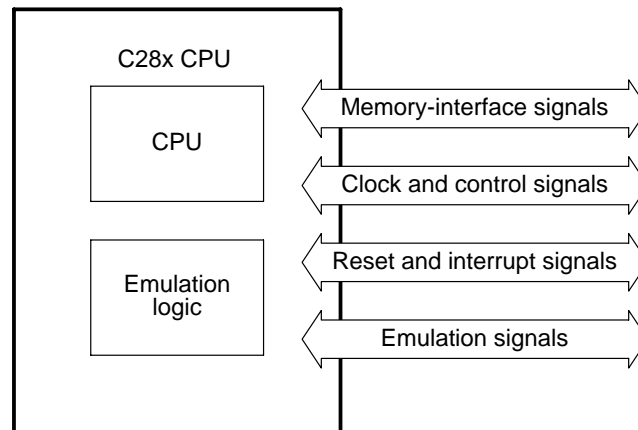
## 1.2 Components of the CPU

As shown in Figure 1–1, the CPU contains:

- ❑ A CPU for generating data- and program-memory addresses; decoding and executing instructions; performing arithmetic, logical, and shift operations; and controlling data transfers among CPU registers, data memory, and program memory
- ❑ Emulation logic for monitoring and controlling various parts and functionalities of the DSP and for testing device operation
- ❑ Signals for interfacing with memory and peripherals, clocking and controlling the CPU and the emulation logic, showing the status of the CPU and the emulation logic, and using interrupts

The CPU does not contain memory, a clock generator, or peripheral devices. For information about interfacing to these items, see the *C28x Peripheral User's Guide* (literature number SPRU566) and the data sheet that corresponds to your DSP.

Figure 1–1. High-Level Conceptual Diagram of the CPU



### 1.2.1 Central Processing Unit (CPU)

The CPU is discussed in more detail in Chapter 2, but following is a list of its major features:

- ❑ Protected pipeline. The CPU implements an 8-phase pipeline that prevents a write to and a read from the same location from occurring out of order.
- ❑ Independent register space. The CPU contains registers that are not mapped to data space. These registers function as system-control

registers, math registers, and data pointers. The system-control registers are accessed by special instructions. The other registers are accessed by special instructions or by a special addressing mode (register addressing mode).

- Arithmetic logic unit (ALU). The 32-bit ALU performs 2s-complement arithmetic and Boolean logic operations.
- Address register arithmetic unit (ARAU). The ARAU generates data-memory addresses and increments or decrements pointers in parallel with ALU operations.
- Barrel shifter. This shifter performs all left and right shifts of data. It can shift data to the left by up to 16 bits and to the right by up to 16 bits.
- Multiplier. The multiplier performs 32-bit  $\times$  32-bit 2s-complement multiplication with a 64-bit result. The multiplication can be performed with two signed numbers, two unsigned numbers, or one signed number and one unsigned number.

### 1.2.2 Emulation Logic

The emulation logic includes the following features. For more details about these features, see Chapter 7, *Emulation Features*.

- Debug-and-test direct memory access (DT-DMA). A debug host can gain direct access to the content of registers and memory by taking control of the memory interface during unused cycles of the instruction pipeline.
- Data logging. The emulation logic enables application-initiated transfers of memory contents between the C28x and a debug host.
- A counter for performance benchmarking
- Multiple debug events. Any of the following *debug events* can cause a break in program execution:
  - A breakpoint initiated by the ESTOP0 or ESTOP1 instruction
  - An access to a specified program-space or data-space location
  - A request from the debug host or other hardware

When a debug event causes the C28x to enter the debug-halt state, the event is called a *break event*.

- Real-time mode of operation. When the C28x is in this mode and a break event occurs, the main body of program code comes to a halt, but time-critical interrupts can still be serviced.

### **1.2.3 Signals**

The CPU has four main types of signals:

- Memory-interface signals. These signals transfer data among the CPU, memory, and peripherals; indicate program-memory accesses and data-memory accesses; and differentiate between accesses of different sizes (16-bit or 32-bit).
- Clock and control signals. These provide clocking for the CPU and the emulation logic, and they are used to control and monitor the CPU.
- Reset and interrupt signals. These are used for generating a hardware reset and interrupts, and for monitoring the status of interrupts.
- Emulation signals. These signals are used for testing and debugging.

## 1.3 Memory Map

The C28x uses 32-bit data addresses and 22-bit program addresses. This allows for a total address reach of 4G words (1 word = 16 bits) in data space and 4M words in program space. Memory blocks on all C28x designs are uniformly mapped to both program and data space. Figure 1–2 shows a high-level view of how addresses are allocated in program space and data space.

The memory map in Figure 1–2 has been divided into the following segments:

- On-chip program/data
- Reserved
- CPU interrupt vectors

For specific details about each of the map segments, see the data sheet for your device. See Appendix C for more information on the C2xLP compatible memory space.

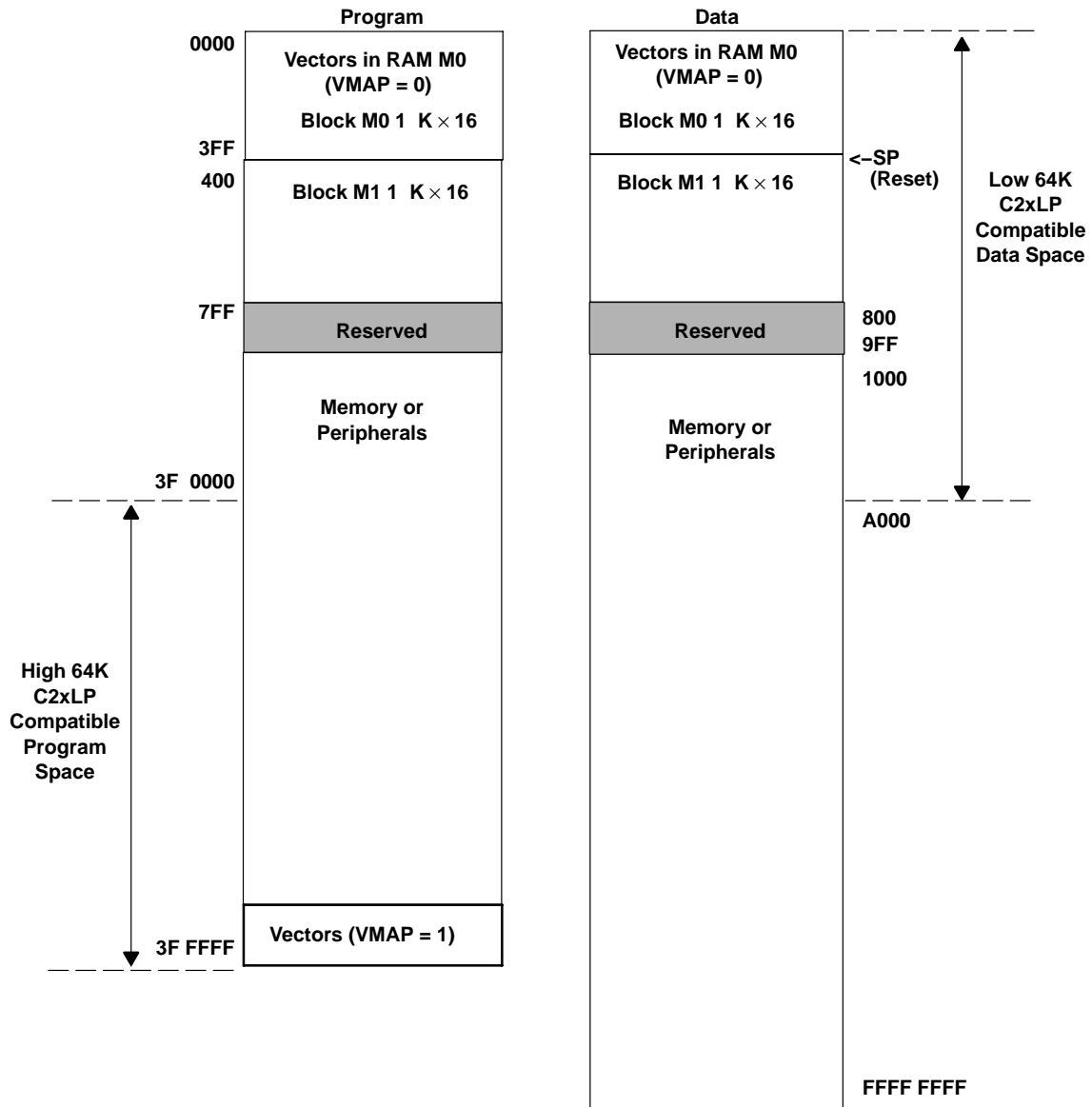
### 1.3.1 CPU Interrupt Vectors

Sixty-four addresses in program space are set aside for a table of 32 CPU interrupt vectors. The CPU vectors can be mapped to the top or bottom of program space by way of the VMAP bit. For more information about the CPU vectors, see Section 3.2, *Interrupt Vectors and Priorities* on page 3-4.

For devices with a peripheral interrupt expansion (PIE) block, the interrupt vectors will reside in the PIE vector table and this memory can be used as program memory.



Figure 1–2. TMS320C28x High-Level Memory Map



See the data sheet for your specific device for details of the exact memory map.

## 1.4 Memory Interface

The C28x memory map is accessible outside the CPU by the memory interface, which connects the CPU logic to memories, peripherals, or other interfaces. The memory interface includes separate buses for program space and data space. This means an instruction can be fetched from program memory while data memory is being accessed.

The interface also includes signals that indicate the type of read or write being requested by the CPU. These signals can select a specified memory block or peripheral for a given bus transaction. In addition to 16-bit and 32-bit accesses, the C28x supports special byte-access instructions which can access the least significant byte (LSByte) or most significant byte (MSByte) of an addressed word. Strobe signals indicate when such an access is occurring on a data bus.

### 1.4.1 Address and Data Buses

The memory interface has three address buses:

**PAB** *Program address bus.* The PAB carries addresses for reads and writes from program space. PAB is a 22-bit bus.

**DRAB** *Data-read address bus.* The 32-bit DRAB carries addresses for reads from data space.

**DWAB** *Data-write address bus.* The 32-bit DWAB carries addresses for writes to data space.

The memory interface also has three data buses:

**PRDB** *Program-read data bus.* The PRDB carries instructions or data during reads from program space. PRDB is a 32-bit bus.

**DRDB** *Data-read data bus.* The DRDB carries data during reads from data space. PRDB is a 32-bit bus.

**DWDB** *Data-/Program-write data bus.* The 32-bit DWDB carries data during writes to data space or program space.

Table 1–2 summarizes how these buses are used during accesses.

*Table 1–2. Summary of Bus Use During Data-Space and Program-Space Accesses*

<b>Access Type</b>	<b>Address Bus</b>	<b>Data Bus</b>
Read from program space	PAB	PRDB
Read from data space	DRAB	DRDB
Write to program space	PAB	DWDB
Write to data space	DWAB	DWDB

A program-space read and a program-space write cannot happen simultaneously because both use the PAB. Similarly, a program-space write and a data-space write cannot happen simultaneously because both use the DWDB. Transactions that use different buses can happen simultaneously. For example, the CPU can read from program space (using PAB and PRDB), read from data space (using DRAB and DRDB), and write to data space (using DWAB and DWDB) at the same time.

#### **1.4.2 Special Bus Operations**

Typically, PAB and PRDB are used only for reading instructions from program space, and DWDB is used only for writing data to data space. However, the instructions in Table 1–3 are exceptions to this behavior. For more details about using these instructions, see Chapter 6, *Assembly Language Instructions*.

Table 1–3. Special Bus Operations

Instruction	Special Bus Operation
PREAD	<p>This instruction reads a data value rather than an instruction from program space. It then transfers that value to data space or a register.</p> <p>For the read from program space, the CPU places the source address on the program address bus (PAB), sets the appropriate program-space select signals, and reads the data value from the program-read data bus (PRDB).</p>
PWRITE	<p>This instruction writes a data value to program space. The value is read from from data space or a register.</p> <p>For the write to program space, the CPU places the destination address on the program address bus (PAB), sets the appropriate program-space select signals, and writes the data value to the data-/program-write data bus (DWDB).</p>
MAC DMAC QMACL IMACL XMAC XMACD	<p>As part of their operation, these instructions multiply two data values, one of which is read from program space.</p> <p>For the read from program space, the CPU places the program-space source address on the program address bus (PAB), sets the appropriate program-space select signals, and reads the program data value from the program read data bus (PRDB).</p>

### 1.4.3 Alignment of 32-Bit Accesses to Even Addresses

The C28x CPU expects memory wrappers or peripheral-interface logic to align any 32-bit read or write to an even address. If the address-generation logic generates an odd address, the CPU must begin reading or writing at the previous even address. This alignment does not affect the address values generated by the address-generation logic.

Most instruction fetches from program space are performed as 32-bit read operations and are aligned accordingly. However, alignment of instruction fetches are effectively invisible to a programmer. When instructions are stored to program space, they do not have to be aligned to even addresses. Instruction boundaries are decoded within the CPU.

You need to be concerned with alignment when using instructions that perform 32-bit reads from or writes to data space.



# Central Processing Unit

---

---

---

---

The central processing unit (CPU) is responsible for controlling the flow of a program and the processing of instructions. It performs arithmetic, Boolean logic, multiply, and shift operations. When performing signed math, the CPU uses 2s-complement notation. This chapter describes the architecture, registers, and primary functions of the CPU.

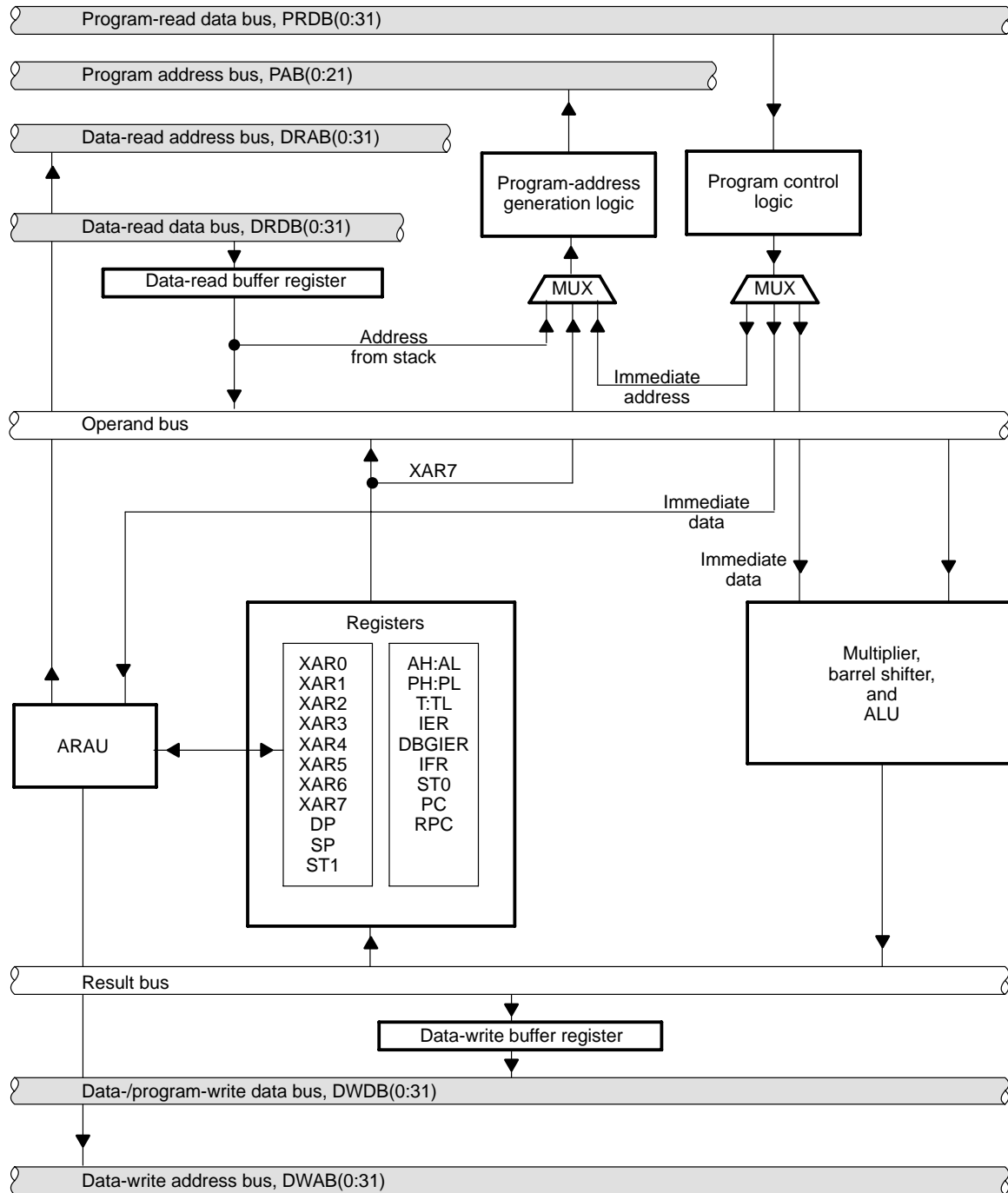
<b>Topic</b>	<b>Page</b>
<b>2.1 CPU Architecture</b> .....	<b>2-2</b>
<b>2.2 CPU Registers</b> .....	<b>2-4</b>
<b>2.3 Status Register ST0</b> .....	<b>2-16</b>
<b>2.4 Status Register ST1</b> .....	<b>2-34</b>
<b>2.5 Program Flow</b> .....	<b>2-39</b>
<b>2.6 Multiply Operations</b> .....	<b>2-41</b>
<b>2.7 Shift Operations</b> .....	<b>2-44</b>

## 2.1 CPU Architecture

All C28x devices contain a central processing unit (CPU), emulation logic, and signals for interfacing with memory and peripherals. Included with these signals are three address buses and three data buses. Figure 2–1 shows the major blocks and data paths of the C28x CPU. It does not reflect the actual silicon implementation. The shaded buses are memory-interface buses that are external to the CPU. The operand bus supplies the values for multiplier, shifter, and ALU operations, and the result bus carries the results to registers and memory. The main blocks of the CPU are:

- Program and data control logic.** This logic stores a queue of instructions that have been fetched from program memory.
- Real-Time emulation and visibility**
- Address register arithmetic unit (ARAU).** The ARAU generates addresses for values that must be fetched from data memory. For a data read, it places the address on the data-read address bus (DRAB); for a data write, it loads the data-write address bus (DWAB). The ARAU also increments or decrements the stack pointer (SP) and the auxiliary registers (XAR0, XAR1, XAR2, XAR3, XAR4, XAR5, XAR6, and XAR7).
- Atomic arithmetic logic unit (ALU).** The 32-bit ALU performs 2s-complement arithmetic and Boolean logic operations. Before doing its calculations, the ALU accepts data from registers, from data memory, or from the program control logic. The ALU saves results to a register or to data memory.
- Prefetch queue and instruction decode**
- Address generators for program and data**
- Fixed-point MPY/ALU.** The multiplier performs 32-bit  $\times$  32-bit 2s-complement multiplication with a 64-bit result. In conjunction with the multiplier, the '28xx uses the 32-bit multiplicand register (XT), the 32-bit product register (P), and the 32-bit accumulator (ACC). The XT register supplies one of the values to be multiplied. The result of the multiplication can be sent to the P register or to ACC.
- Interrupt processing**

Figure 2–1. Conceptual Block Diagram of the CPU





## 2.2 CPU Registers

Table 2–1 lists the main CPU registers and their values after reset. Sections 2.2.1 through 2.2.10 describe the registers in more detail. Figure 2–2 shows the registers.

*Table 2–1. CPU Register Summary*

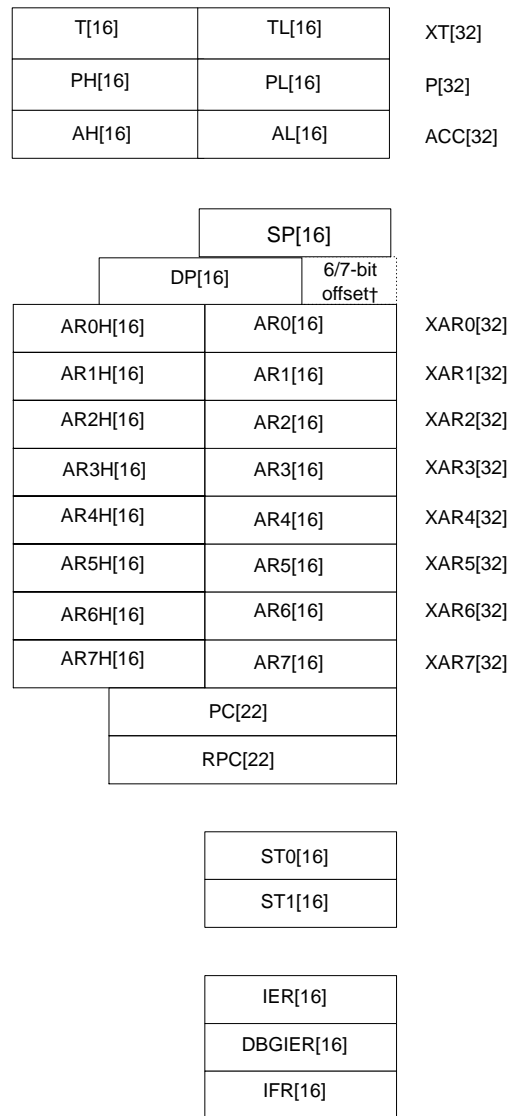
<b>Register</b>	<b>Size</b>	<b>Description</b>	<b>Value After Reset</b>
ACC	32 bits	Accumulator	0x00000000
AH	16 bits	High half of ACC	0x0000
AL	16 bits	Low half of ACC	0x0000
XAR0	16 bits	Auxiliary register 0	0x00000000
XAR1	32 bits	Auxiliary register 1	0x00000000
XAR2	32 bits	Auxiliary register 2	0x00000000
XAR3	32 bits	Auxiliary register 3	0x00000000
XAR4	32 bits	Auxiliary register 4	0x00000000
XAR5	32 bits	Auxiliary register 5	0x00000000
XAR6	32 bits	Auxiliary register 6	0x00000000
XAR7	32 bits	Auxiliary register 7	0x00000000
AR0	16 bits	Low half of XAR0	0x0000
AR1	16 bits	Low half of XAR1	0x0000
AR2	16 bits	Low half of XAR2	0x0000
AR3	16 bits	Low half of XAR3	0x0000
AR4	16 bits	Low half of XAR4	0x0000
AR5	16 bits	Low half of XAR5	0x0000
AR6	16 bits	Low half of XAR6	0x0000
AR7	16 bits	Low half of XAR7	0x0000

Table 2–1. CPU Register Summary (Continued)

Register	Size	Description	Value After Reset
DP	16 bits	Data-page pointer	0x0000
IFR	16 bits	Interrupt flag register	0x0000
IER	16 bits	Interrupt enable register	0x0000 (INT1 to INT14, DLOGINT, RTOSINT disabled)
DBGIER	16 bits	Debug interrupt enable register	0x0000 (INT1 to INT14, DLOGINT, RTOSINT disabled)
P	32 bits	Product register	0x00000000
PH	16 bits	High half of P	0x0000
PL	16 bits	Low half of P	0x0000
PC	22 bits	Program counter	0x3F FFC0
RPC	22 bits	Return program counter	0x00000000
SP	16 bits	Stack pointer	0x0400
ST0	16 bits	Status register 0	0x0000
ST1	16 bits	Status register 1	0x080B <sup>†</sup>
XT	32 bits	Multiplicand register	0x00000000
T	16 bits	High half of XT	0x0000
TL	16 bits	Low half of XT	0x0000

<sup>†</sup> Reset value shown is for devices without the VMAP signal and MOM1MAP signal pinned out. On these devices both of these signals are tied high internal to the device.

Figure 2–2. C28x Registers



† A 6-bit offset is used when operating in C28x mode or C27x object-compatible mode.  
 A 7-bit offset is used when operating in C2xLP source-compatible mode. The least significant bit of the DP is ignored when operating in this mode.

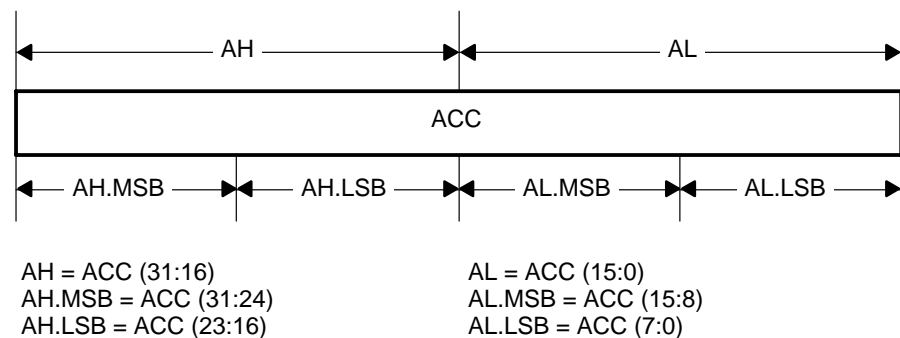
### 2.2.1 Accumulator (ACC, AH, AL)

The accumulator (ACC) is the main working register for the device. It is the destination for all ALU operations except those which operate directly on memory or registers. ACC supports single-cycle move, add, subtract, and

compare operations from 32-bit-wide data memory. It can also accept the 32-bit result of a multiplication operation.

The halves and quarters of the ACC can also be accessed (see Figure 2–3). ACC can be treated as two independent 16-bit registers: AH (high 16 bits) and AL (low 16 bits). The bytes within AH and AL can also be accessed independently. Special byte-move instructions load and store the most significant byte or least significant byte of AH or AL. This enables efficient byte packing and unpacking.

Figure 2–3. Individually Accessible Portions of the Accumulator



The accumulator has the following associated status bits. For the details on these bits, see section 2.3, *Status Register ST0*.

- Overflow mode bit (OVM)
- Sign-extension mode bit (SXM)
- Test/control flag bit (TC)
- Carry bit (C)
- Zero flag bit (Z)
- Negative flag bit (N)
- Latched overflow flag bit (V)
- Overflow counter bits (OVC)

Table 2–2 shows the ways to shift the content of AH, AL, or ACC.

Table 2–2. Available Operations for Shifting Values in the Accumulator

Register	Shift Direction	Shift Type	Instruction
ACC	Left	Logical	LSL or LSLL
		Rotation	ROL
	Right	Arithmetic	SFR with SXM = 1 or ASRL
		Logical	SFR with SXM = 0 or LSRL
AH or AL	Left	Rotation	ROR
		Logical	LSL
	Right	Arithmetic	ASR
		Logical	LSR

### 2.2.2 Multiplicand Register (XT)

The multiplicand register (XT register) is used primarily to store a 32-bit signed integer value prior to a 32-bit multiply operation.

The lower 16-bit portion of the XT register is referred to as the TL register. This register can be loaded with a signed 16-bit value that is automatically sign-extended to fill the 32-bit XT register.

The upper 16-bit portion of the XT register is referred to as the T register. The T register is mainly used to store a 16-bit integer value prior to a 16-bit multiply operation.

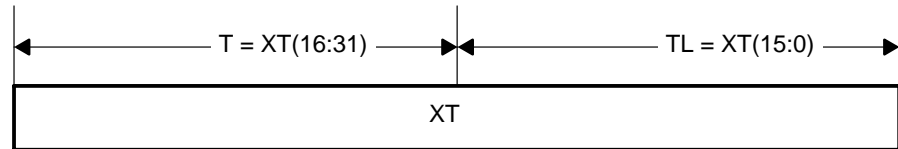
The T register is also used to specify the shift value for some shift operations. In this case, only a portion of the T register is used, depending on the instruction.

For example:

ASR AX, T	performs an arithmetic shift right based on the four least significant bits of T: T(3:0) = 0...15
ASRL ACC, T	performs an arithmetic shift right by the five least significant bits of T: T(4:0) 0...31

For these operations, the most significant bits of T are ignored.

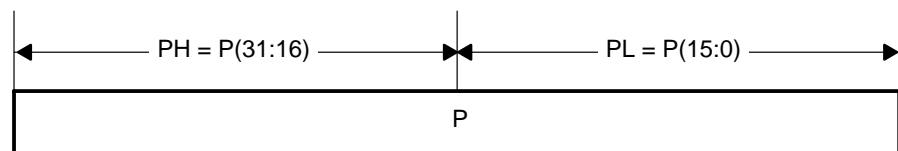
Figure 2–4. Individually Accessible Halves of the XT Register



### 2.2.3 Product Register (P, PH, PL)

The product register (P register) is typically used to hold the 32-bit result of a multiplication. It can also be loaded directly from a 16- or 32-bit data-memory location, a 16-bit constant, the 32-bit ACC, or a 16-bit or a 32-bit addressable CPU register. The P register can be treated as a 32-bit register or as two independent 16-bit registers: PH (high 16 bits) and PL (low 16 bits); see Figure 2–5.

Figure 2–5. Individually Accessible Halves of the P Register



When some instructions access P, PH, or PL, all 32-bits are copied to the ALU-shifter block, where the barrel shifter may perform a left shift, a right shift, or no shift. The action of the shifter for these instructions is determined by the product shift mode (PM) bits in status register ST0. Table 2–3 shows the possible PM values and the corresponding product shift modes. When the barrel shifter performs a left shift, the low order bits are filled with zeros. When the shifter performs a right shift, the P register value is sign extended. Instructions that use PH or PL as operands ignore the product shift mode.

For a complete list of instructions affected by PM bits, see Table 2–5 on page 2-20.

Table 2–3. Product Shift Modes

PM Value	Product Shift Mode
000 <sub>2</sub>	Left shift by 1
001 <sub>2</sub>	No shift
010 <sub>2</sub>	Right shift by 1
011 <sub>2</sub>	Right shift by 2
100 <sub>2</sub>	Right shift by 3
101 <sub>2</sub>	Right shift by 4 (if AMODE = 1, left 4)
110 <sub>2</sub>	Right shift by 5
111 <sub>2</sub>	Right shift by 6

#### 2.2.4 Data Page Pointer (DP)

In the direct addressing modes, data memory is addressed in blocks of 64 words called *data pages*. The lower 4M words of data memory consists of 65 536 data pages labeled 0 through 65 535, as shown in Figure 2–6. In DP direct addressing mode, the 16-bit data page pointer (DP) holds the current data page number. You change the data page by loading the DP with a new number. For information about the direct addressing modes, see section 5.4 on page 5-8.

Figure 2–6. Pages of Data Memory

Data page	Offset	Data memory
00 0000 0000 0000 00 ⋮	00 0000 ⋮	Page 0: 0000 0000–0000 003F
00 0000 0000 0000 00 ⋮	11 1111 ⋮	Page 1: 0000 0040–0000 007F
00 0000 0000 0000 01 ⋮	00 0000 ⋮	Page 2: 0000 0080–0000 00BF
00 0000 0000 0000 01 ⋮	11 1111 ⋮	
00 0000 0000 0000 10 ⋮	00 0000 ⋮	
00 0000 0000 0000 10 ⋮	11 1111 ⋮	
⋮	⋮	⋮
⋮	⋮	⋮
⋮	⋮	⋮
⋮	⋮	⋮
⋮	⋮	⋮
11 1111 1111 1111 11 ⋮	00 0000 ⋮	Page 65 535: 003F FFC0–003F FFFF
11 1111 1111 1111 11 ⋮	11 1111 ⋮	

Data memory above 4M words is not accessible using the DP.

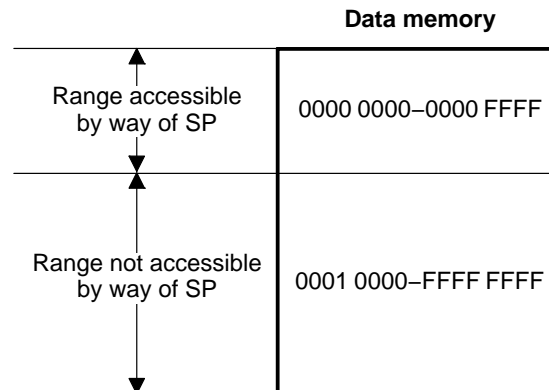
When operating in C2xLP source-compatible mode, a 7-bit offset is used and the least significant bit of the DP register is ignored. See Appendix C for more details.

### 2.2.5 Stack Pointer (SP)

The stack pointer (SP) enables the use of a software stack in data memory. The stack pointer has only 16 bits and can only address the low 64K of data space (see Figure 2–7). When the SP is used, the upper six bits of the 32-bit address are forced to 0. (For information about addressing modes that use the SP, see section 5.5 on page 5-9.) After reset, SP points to address 0000 0400<sub>16</sub>.



Figure 2–7. Address Reach of the Stack Pointer



The operation of the stack is as follows:

- The stack grows from low memory to high memory.
- The SP always points to the next empty location in the stack.
- At reset, the SP is initialized, so that it points to address 0000 0400<sub>16</sub>.
- When 32-bit values are saved to the stack, the least significant 16 bits are saved first, and the most significant 16 bits are saved to the next higher address (little endian format).
- When 32-bit operations read or write a 32-bit value, the C28x CPU expects the memory wrapper or peripheral-interface logic to align that read or write to an even address. For example, if the SP contains the odd address 0000 0083<sub>16</sub>, a 32-bit read operation reads from addresses 0000 0082<sub>16</sub> and 0000 0083<sub>16</sub>.
- The SP overflows if its value is increased beyond FFFF<sub>16</sub> or decreased below 0000<sub>16</sub>. When the SP increases past FFFF<sub>16</sub>, it counts forward from 0000<sub>16</sub>. For example, if SP = FFFE<sub>16</sub> and an instruction adds 3 to the SP, the result is 0001<sub>16</sub>. When the SP decreases past 0000<sub>16</sub>, it counts backward from FFFF<sub>16</sub>. For example, if SP = 0002<sub>16</sub> and an instruction subtracts 4 from SP, the result is FFFE<sub>16</sub>.
- When values are being saved to the stack, the SP is not forced to align with even or odd addresses. Alignment is forced by the memory wrapper or peripheral-interface logic.

### 2.2.6 Auxiliary Registers (XAR0–XAR7, AR0–AR7)

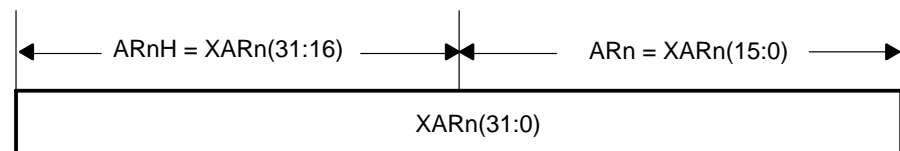
The CPU provides eight 32-bit registers that can be used as pointers to memory or as general-purpose registers (see Section 5.6, *Indirect Addressing*)

*Modes*, on page 5-10 . The auxiliary registers are: XAR0, XAR1, XAR2, XAR3, XAR4, XAR5, XAR6, and XAR7.

Many instructions allow you to access the 16 LSBs of XAR0–XAR7. As shown in Figure 2–8, the 16 LSBs of the auxiliary registers are referred to as AR0–AR7. AR0–AR7 can be used as general purpose registers for loop control and for efficient 16-bit comparisons.

When accessing AR0–AR7, the upper 16 bits of the register (known as AR0H–AR7H) may or may not be modified, depending on the instruction used (see Chapter 6 for information on the behavior of particular instructions). AR0H–AR7H are accessed only as part of XAR0–XAR7 and are not individually accessible.

Figure 2–8. XAR0 – XAR7 Registers



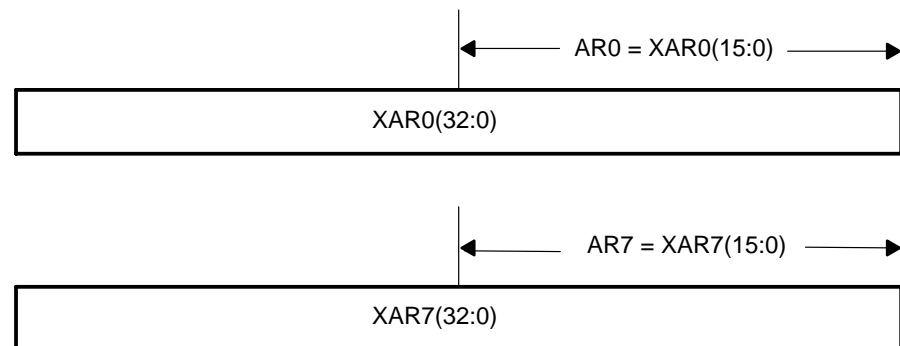
n = number 0 through 7

For ACC operations, all 32 bits are valid (@XARn). For 16-bit operations, the lower 16 bits are used and upper 16 bits are ignored (@ARn).

XAR0 – XAR7 can also be used by some instructions to point to any value in program memory; see Section 5.6, *Indirect Addressing Modes*.

Many instructions allow you to access the 16 least significant bits (LSBs) of XAR0–XAR7. As shown in Figure 2–9, 16 LSBs of XAR0–XAR7 are known as one auxiliary register of AR0–AR7.

Figure 2–9. XAR0 – XAR7



### 2.2.7 Program Counter (PC)

When the pipeline is full, the 22-bit program counter (PC) always points to the instruction that is currently being processed — the instruction that has just reached the decode 2 phase of the pipeline. Once an instruction reaches this phase of the pipeline, it cannot be flushed from the pipeline by an interrupt. It is executed before the interrupt is taken. The pipeline is discussed in Chapter 4.

### 2.2.8 Return Program Counter (RPC)

When a call operation is performed using the LCR instruction, the return address is saved in the RPC register and the old value in the RPC is saved on the stack (in two 16-bit operations). When a return operation is performed using the LRETR instruction, the return address is read from the RPC register and the value on the stack is written into the RPC register (in two 16-bit operations). Other call instructions do not use the RPC register. For more information, see the instructions in Chapter 6.

### 2.2.9 Status Registers (ST0, ST1)

The C28x has two status registers, ST0 and ST1, which contain various flag bits and control bits. These registers can be stored into and loaded from data memory, enabling the status of the machine to be saved and restored for sub-routines.

The status bits have been organized according to when the bit values are modified in the pipeline. Bits in ST0 are modified in the execute phase of the pipeline; bits in ST1 are modified in the decode 2 phase. (For details about the pipeline, see Chapter 4.) The status bits are described in detail in sections 2.3 (ST0) and 2.4 (ST1). Also, ST0 and ST1 are included in Appendix A, *Register Quick Reference*.

### 2.2.10 Interrupt-Control Registers (IFR, IER, DBGIER)

The C28x CPU has three registers dedicated to the control of interrupts:

- Interrupt flag register (IFR)
- Interrupt enable register (IER)
- Debug interrupt enable register (DBGIER)

These registers handle interrupts at the CPU level. Devices with a peripheral interrupt expansion (PIE) block will have additional interrupt control as part of the PIE module.

The IFR contains flag bits for maskable interrupts (those that can be enabled and disabled with software). When one of these flags is set, by hardware or

software, the corresponding interrupt will be serviced if it is enabled. You enable or disable a maskable interrupt with its corresponding bit in the IER. The DBGIER indicates the time-critical interrupts that will be serviced (if enabled) while the DSP is in real-time emulation mode and the CPU is halted.

The C28x CPU interrupts and the interrupt-control registers are described in detail in Chapter 3, *Interrupts*. Also, the IFR, IER, and DBGIER are included in Appendix A, *Register Quick Reference*.

## 2.3 Status Register (ST0)

The following figure shows the bit fields of status register (ST0). All of these bit fields are modified in the execute phase of the pipeline. Detailed descriptions of these bits follow the figure.

Figure 2–10. Bit Fields of Status Register (ST0)

15	10	9	7	6	5	4	3	2	1	0	
OVC/OVCU		PM			V	N	Z	C	TC	OVM	SXM
R/W-00 0000		R/W-0			RW-0	RW-0	RW-0	RW-0	RW-0	RW-0	RW-0

**Note:** R = Read access; W = Write access; value following dash (–) is value after reset.

### OVC/OVCU Bits15–10

**Overflow counter.** The overflow counter behaves differently for signed and unsigned operations.

For signed operations, the overflow counter is a 6-bit signed counter with a range of –32 to 31. When overflow mode is off (OVM = 0), ACC overflows normally, and OVC keeps track of overflows. When overflow mode is on (OVM = 1) and an overflow occurs in ACC, the OVC is not affected. Instead, the CPU automatically fills ACC with a positive or negative saturation value (see the description for OVM on page 2-32).

When ACC overflows in the positive direction (from 7FFF FFFF<sub>16</sub> to 8000 0000<sub>16</sub>), the OVC is incremented by 1. When ACC overflows in the negative direction (from 8000 0000<sub>16</sub> to 7FFF FFFF<sub>16</sub>) the OVC is decremented by 1. The increment or decrement is performed as the overflow affects the V flag.

For unsigned operations (OVCU), the counter increments for ADD when a Carry is generated and decrements for a SUB when a Borrow is generated (similar to a carry counter).

If OVC increments past its most positive value, 31, the counter wraps around to –32. If OVC decrements past its most negative value, –32, the counter wraps around to 31. At reset, OVC is cleared.

OVC is not affected by overflows in registers other than ACC and is not affected by compare instructions (CMP and CMPL). The table that follows explains how OVC may be affected by the saturate accumulator (SAT ACC) instruction.

Table 2–4 lists the instructions affecting OVC/OVCU. See the instruction set in Chapter 6 for a complete description of each instruction.

Table 2–4. Instructions That Affect OVC/OVCU

<b>Signed Addition Instructions</b>	<b>Effect on OVC/OVCU</b>
ADD ACC,loc16 << shift	if(OVM == 0) Inc OVC on +ve signed overflow
ADD ACC,#16bit << shift	
ADD ACC,loc16 << T	
ADD loc16,#16bitSigned	
ADDB ACC,#8bit	
ADDCL ACC,loc32	
ADDCU ACC,loc16	
ADDL ACC,loc32	
ADDL loc32,ACC	
ADDU ACC,loc16	
DMAC ACC:P,loc32,*XAR7/++	
INC loc16	
MAC P,loc16,*XAR7/++	
MAC P,loc16,0:pma	
MOVA T,loc16	
MOVAD T,loc16	
MPYA P,loc16,#16bit	
MPYA P,T,loc16	
QMACL P,loc32,*XAR7/++	
QMPYAL P,XT,loc32	
SQRA loc16	
XMAC P,loc16,*(pma)	
XMACD P,loc16,*(pma)	
<b>Signed Subtraction Instructions</b>	<b>Effect on OVC/OVCU</b>
DEC loc16	if(OVM == 0) Dec OVC on –ve signed overflow
MOVS T,loc16	

Table 2–4. Instructions That Affect OVC/OVCU (Continued)

<b>Signed Addition Instructions</b>	<b>Effect on OVC/OVCU</b>
MPYS P,T,loc16	
QMPYSL P,XT,loc32	
SBBU ACC,loc16	
SQRS loc16	
SUB ACC,#16bit << shift	
SUB ACC,loc16 << shift	
SUB ACC,loc16 << T	
SUBB ACC,#8bit	
SUBBL ACC,loc32	
SUBL ACC,loc32	
SUBL loc32,ACC	
SUBRL loc32,ACC	
SUBU ACC,loc16	
SUBUL ACC,loc32	
SUBUL P,loc32	
<b>Unsigned Instructions</b>	<b>Effect on OVC/OVCU</b>
ADDUL ACC,loc32	Inc OVC/OVCU on unsigned carry
ADDUL P,loc32	
IMPYAL P,XT,loc32	
IMACL P,loc32,*XAR7/++	
<b>Misc Instructions</b>	<b>Effect on OVC/OVCU</b>
SAT ACC	if(OVC > 0) Saturate +ve if(OVC < 0) Saturate -ve OVC = 0
SAT64 ACC:P	
ZAPA	OVC = 0
ZAP OVC	
MOV OVC,loc16	OVC = [loc16(15:10)]

Table 2–4. Instructions That Affect OVC/OVCU (Continued)

Signed Addition Instructions	Effect on OVC/OVCU
MOVU OVC,loc16	OVC = [loc16(5:0)]

Condition	Operation Performed by SAT ACC Instruction
OVC = 0	Leave ACC and OVC unchanged.
OVC > 0	Saturate ACC in the positive direction (fill ACC with 7FFF FFFF <sub>16</sub> ), and clear OVC.
OVC < 0	Saturate ACC in the negative direction (fill ACC with 8000 0000 <sub>16</sub> ), and clear OVC.

**PM**  
Bits 9–7

**Product shift mode bits.** This 3-bit value determines the shift mode for any output operation from the product (P) register. The shift modes are shown in the following table. The output can be to the ALU or to memory. All instructions that are affected by the product shift mode will sign extend the P register value during a right shift operation. At reset, PM is cleared (left shift by 1 bit is the default).

PM is summarized as follows:

000	Left shift by 1. During the shift, the low-order bit is zero filled. At reset, this mode is selected.
001	No shift
010	Right shift by 1. During the shift, the lower bits are lost, and the shifted value is sign extended.
011	Right shift by 2. During the shift, the lower bits are lost, and the shifted value is sign extended.
100	Right shift by 3. During the shift, the lower bits are lost, and the shifted value is sign extended.
101	Right shift by 4. During the shift, the lower bits are lost, and the shifted value is sign extended. Note, if AMODE = 1, then 101 is a left shift by 4.
110	Right shift by 5. During the shift, the lower bits are lost, and the shifted value is sign extended.
111	Right shift by 6. During the shift, the lower bits are lost, and the shifted value is sign extended.

**Note:** For performing unsigned arithmetic, you must use a product shift of 0 (PM = 001) to avoid sign extension and generation of incorrect results.

Table 2–5 lists instructions that are affected by the PM bits. See the instruction set in chapter 6 for a complete description of each instruction.



Table 2–5. Instructions Affected by the PM Bits

Instruction	Effect of PM
CMPL ACC,P << PM	flags set on(ACC – P << PM)
DMAC ACC:P,loc32,*XAR7/++	ACC = ACC + MSW*MSW << PM P = P + LSW*LSW << PM
IMACL P,loc32,*XAR7/++	P = ([loc32] * Prog[*XAR7/++]) << PM
IMPYAL P,XT,loc32	P = (XT * [loc32]) << PM
IMPYL P,XT,loc32	P = (XT * [loc32]) << PM
IMPYSL P,XT,loc32	ACC = ACC – P unsigned P = (XT * [loc32]) << PM
IMPYXUL P,XT,loc32	P = (XT sign * [loc32]uns) << PM
MAC P,loc16,*XAR7/++	ACC = ACC + P << PM
MAC P,loc16,0:pma	ACC = ACC + P << PM
MOV loc16,P	[loc16] = low(P << PM)
MOVA T,loc16	ACC = ACC + P << PM
MOVAD T,loc16	ACC = ACC + P << PM
MOVH loc16,P	[loc16] = high(P << PM)
MOVP T,loc16	ACC = P << PM
MOVST T,loc16	ACC = ACC – P << PM
MPYA P,loc16,#16bit	ACC = ACC + P << PM
MPYA P,T,loc16	ACC = ACC + P << PM
MPYS P,T,loc16	ACC = ACC – P << PM
QMACL P,loc32,*XAR7	ACC = ACC + P << PM
QMACL P,loc32,*XAR7++	ACC = ACC + P << PM
QMPYAL P,XT,loc32	ACC = ACC + P << PM
QMPYSL P,XT,loc32	ACC = ACC – P << PM
SQRA loc16	ACC = ACC + P << PM
SQRS loc16	ACC = ACC – P << PM
XMAC P,loc16,*(pma)	ACC = ACC + P << PM
XMACD P,loc16,*(pma)	ACC = ACC + P << PM

**V**  
Bit 6

**Overflow flag.** If the result of an operation causes an overflow in the register holding the result, V is set and latched. If no overflow occurs, V is not modified. Once V is latched, it remains set until it is cleared by reset or by a conditional branch instruction that tests V. Such a conditional branch clears V regardless of whether the tested condition ( $V = 0$  or  $V = 1$ ) is true.

An overflow occurs in ACC (and V is set) if the result of an addition or subtraction does not fit within the signed numerical range  $-2^{31}$  to  $(+2^{31} - 1)$ , or  $8000\ 0000_{16}$  to  $7FFF\ FFFF_{16}$ .

An overflow occurs in AH, AL, or another 16-bit register or data-memory location if the result of an addition or subtraction does not fit within the signed numerical range  $-2^{15}$  to  $(+2^{15} - 1)$ , or  $8000_{16}$  to  $7FFF_{16}$ .

The instructions CMP, CMPB and CMPL do not affect the state of the V flag. Table 2–6 lists the instructions that are affected by V flag. See Chapter 6 for more details on instructions.

V can be summarized as follows:

- 0 V has been cleared.
- 1 An overflow has been detected, or V has been set.

*Table 2–6. Instructions Affected by V flag*

Instruction	Description
ABS ACC	if(ACC == 0x8000 0000) V = 1
ABSTC ACC	if(ACC == 0x8000 0000) V = 1
ADD ACC,#16bit << shift	V = 1 on signed overflow
ADD ACC,loc16 << shift	V = 1 on signed overflow
ADD ACC,loc16 << T	V = 1 on signed overflow
ADD AX,loc16	V = 1 on signed overflow
ADD loc16,#16bitSigned	V = 1 on signed overflow
ADD loc16,AX	V = 1 on signed overflow
ADDB ACC,#8bit	V = 1 on signed overflow
ADDB AX,#8bitSigned	V = 1 on signed overflow
ADDCL ACC,loc32	V = 1 on signed overflow
ADDCU ACC,loc16	V = 1 on signed overflow
ADDL ACC,loc32	V = 1 on signed overflow
ADDL loc32,ACC	V = 1 on signed overflow
ADDU ACC,loc16	V = 1 on signed overflow
ADDUL ACC,loc32	V = 1 on signed overflow

Table 2–6. Instructions Affected by V flag (Continued)

Instruction	Description
ADDUL P,loc32	V = 1 on signed overflow
B 16bitOff,COND	V = 0 if tested
BF 16bitOff,COND	V = 0 if tested
DEC loc16	V = 1 on signed overflow
DMAC ACC:P,loc32,*XAR7/++	V = 1 on signed overflow
IMACL P,loc32,*XAR7/++	V = 1 on signed overflow
IMPYAL P,XT,loc32	V = 1 on signed overflow
IMPYSL P,XT,loc32	V = 1 on signed overflow
INC loc16	V = 1 on signed overflow
MAC P,loc16,*XAR7/++	V = 1 on signed overflow
MAC P,loc16,0:pma	V = 1 on signed overflow
MAX AX,loc16	if((AX – [loc16]) < 0) V = 1
MAXL ACC,loc32	if((ACC – [loc32]) < 0) V = 1
MIN AX,loc16	if((AX – [loc16]) > 0) V = 1
MINL ACC,loc32	if((ACC – [loc32]) > 0) V = 1
MOV loc16,AX,COND	V = 0 if tested
MOVA T,loc16	V = 1 on signed overflow
MOVAD T,loc16	V = 1 on signed overflow
MOVB loc16,#8bit,COND	V = 0 if tested
MOVL loc32,ACC,COND	V = 0 if tested
MOVVS T,loc16	V = 1 on signed overflow
MPYA P,loc16,#16bit	V = 1 on signed overflow
MPYA P,T,loc16	V = 1 on signed overflow
MPYS P,T,loc16	V = 1 on signed overflow
NEG ACC	if(ACC == 0x8000 0000) V = 1
NEG AX	if(AX == 0x8000) V = 1
NEG64 ACC:P	if(ACC:P == 0x80....00) V = 1

Table 2–6. Instructions Affected by V flag (Continued)

Instruction	Description
NEGTC ACC	if(TC == 1) if(ACC == 0x8000 0000) V = 1
QMACL P,loc32,*XAR7/++	V = 1 on signed overflow
QMPYAL P,XT,loc32	V = 1 on signed overflow
QMPYSL P,XT,loc32	V = 1 on signed overflow
SAT ACC	if(OVC == 0) V = 0 else V = 1
SAT64 ACC:P	if(OVC == 0) V = 0 else V = 1
SB 8bitOff,COND	V = 0 if tested
SBBU ACC,loc16	V = 1 on signed overflow
SQRA loc16	V = 1 on signed overflow
SQRS loc16	V = 1 on signed overflow
SUB ACC,#16bit << shift	V = 1 on signed overflow
SUB ACC,loc16 << shift	V = 1 on signed overflow
SUB ACC,loc16 << T	V = 1 on signed overflow
SUB AX,loc16	V = 1 on signed overflow
SUB loc16,AX	V = 1 on signed overflow
SUBB ACC,#8bit	V = 1 on signed overflow
SUBBL ACC,loc32	V = 1 on signed overflow
SUBL ACC,loc32	V = 1 on signed overflow
SUBL loc32,ACC	V = 1 on signed overflow
SUBR loc16,AX	V = 1 on signed overflow
SUBRL loc32,ACC	V = 1 on signed overflow
SUBU ACC,loc16	V = 1 on signed overflow
SUBUL ACC,loc32	V = 1 on signed overflow
SUBUL P,loc32	V = 1 on signed overflow
XB pma,COND	V = 0 if tested
XCALL pma,COND	V = 0 if tested
XMAC P,loc16,*(pma)	V = 1 on signed overflow

Table 2–6. Instructions Affected by V flag (Continued)

Instruction	Description
XMACD P,loc16,*(pma)	V = 1 on signed overflow
XRETC COND	V = 0 if tested

**N**  
Bit 5

**Negative flag.** During certain operations, N is set if the result of the operation is a negative number or cleared if the result is a positive number. At reset, N is cleared.

Results in ACC are tested for the negative condition. Bit 31 of ACC is the sign bit. If bit 31 is a 0, ACC is positive; if bit 31 is a 1, ACC is negative. N is set if a result in ACC is negative or cleared if a result is positive.

Results in AH, AL, and other 16-bit registers or data-memory locations are also tested for the negative condition. In these cases bit 15 of the value is the sign bit (1 indicates negative, 0 indicates positive). N is set if the value is negative or cleared if the value is positive.

The TEST ACC instruction sets N if the value in ACC is negative. Otherwise the instruction clears N.

As shown in Table 2–7, under overflow conditions, the way the N flag is set for compare operations is different from the way it is set for addition or subtraction operations. For addition or subtraction operations, the N flag is set to match the most significant bit of the truncated result. For compare operations, the N flag assumes infinite precision. This applies to operations whose result is loaded to ACC, AH, AL, another register, or a data-memory location.

Table 2–7. Negative Flag Under Overflow Conditions

A <sup>†</sup>	B <sup>†</sup>	(A – B)	Subtraction	Compare <sup>‡</sup>
		Neg		
Pos	Neg	(due to overflow in positive direction)	N = 1	N = 0
		Pos		
Neg	Pos	(due to overflow in negative direction)	N = 0	N = 1

<sup>†</sup> For 32-bit data: Pos = Positive number from 0000 0000<sub>16</sub> to 7FFF FFFF<sub>16</sub>  
Neg = Negative number from 8000 0000<sub>16</sub> to FFFF FFFF<sub>16</sub>

For 16-bit data: Pos = Positive number from 0000<sub>16</sub> to 7FFF<sub>16</sub>  
Neg = Negative number from 8000<sub>16</sub> to FFFF<sub>16</sub>

<sup>‡</sup> The compare instructions are CMP, CMPB, CMPL, MIN, MAX, MINL, and MAXL.

N can be summarized as follows:

- 0 The tested number is positive, or N has been cleared.
- 1 The tested number is negative, or N has been set.

**Z**  
Bit 4      **Zero flag.** Z is set if the result of certain operations is 0 or is cleared if the result is nonzero. This applies to results that are loaded into ACC, AH, AL, another register, or a data-memory location. At reset, Z is cleared.

The TEST ACC instruction sets Z if the value in ACC is 0. Otherwise, it clears Z.

Z can be summarized as follows:

- 0      The tested number is nonzero, or Z has been cleared.
- 1      The tested number is 0, or Z has been set.

**C**  
Bit 3      **Carry bit.** This bit indicates when an addition or increment generates a carry or when a subtraction, compare, or decrement generates a borrow. It is also affected by rotate operations on ACC and barrel shifts on ACC, AH, and AL.

During additions/increments, C is set if the addition generates a carry; otherwise C is cleared. There is one exception: If you are using the ADD instruction with a shift of 16, the ADD instruction can set C but cannot clear C.

During subtractions/decrements/compares, C is cleared if the subtraction generates a carry; otherwise C is set. There is one exception: if you are using the SUB instruction with a shift of 16, the SUB instruction can clear C but cannot set C.

This bit can be individually set and cleared by the SETC C instruction and CLRC C instruction, respectively. At reset, C is cleared.

C can be summarized as follows:

- 0      A subtraction generated a borrow, an addition did not generate a carry, or C has been cleared. *Exception:* An ADD instruction with a shift of 16 cannot clear C.
- 1      An addition generated a carry, a subtraction did not generate a borrow, or C has been set. *Exception:* A SUB instruction with a shift of 16 cannot set C.

Table 2–8 lists the bits that are affected by the C bit. For more information on instructions, see Chapter 6.

*Table 2–8. Bits Affected by the C Bit*

Instruction	Affect of or Affect on C
ABS ACC	C = 0
ABSTC ACC	C = 0
ADD ACC,#16bit << shift	C = 1 on carry else C = 0
ADD ACC,loc16 << shift	if(shift == 16) C = 1 on carry if(shift != 16) C = 1 on carry else C = 0

Table 2–8. Bits Affected by the C Bit (Continued)

Instruction	Affect of or Affect on C
ADD ACC,loc16 << T	C = 1 on carry else C = 0
ADD AX,loc16	C = 1 on carry else C = 0
ADD loc16,#16bitSigned	C = 1 on carry else C = 0
ADD loc16,AX	C = 1 on carry else C = 0
ADDB ACC,#8bit	C = 1 on carry else C = 0
ADDB AX,#8bitSigned	C = 1 on carry else C = 0
ADDCL ACC,loc32	ACC = ACC + [loc32] + C C = 1 on carry else C = 0
ADDCU ACC,loc16	ACC = ACC + [loc16] + C C = 1 on carry else C = 0
ADDL ACC,loc32	C = 1 on carry else C = 0
ADDL loc32,ACC	C = 1 on carry else C = 0
ADDU ACC,loc16	C = 1 on carry else C = 0
ADDUL ACC,loc32	C = 1 on carry else C = 0
ADDUL P,loc32	C = 1 on carry else C = 0
ASR AX,1..16	C = AX(bit(shift–1))
ASR AX,T	if(T == 0) C = 0 else C = AX(bit(T–1))
ASR64 ACC:P,1..16	C = P(bit(shift–1))
ASR64 ACC:P,T	if(T == 0) C = 0 else C = P(bit(T–1))
ASRL ACC,T	if(T == 0) C = 0 else C = ACC(bit(T–1))
B 16bitOff,COND	C bit used as test condition
BF 16bitOff,COND	C bit used as test condition
CLRC C	C = 0
CMP AX,loc16	C = 0 on borrow else C = 1

Table 2–8. Bits Affected by the C Bit (Continued)

Instruction	Affect of or Affect on C
CMP loc16,#16bitSigned	for([loc16] – 16bitSigned) C = 0 on borrow else C = 1
CMPB AX,#8bit	C = 0 on borrow else C = 1
CMPL ACC,loc32	for(ACC – [loc32]) C = 0 on borrow else C = 1
CMPL ACC,P << PM	for(ACC – P << PM) C = 0 on borrow else C = 1
DEC loc16+	C = 0 on borrow else C = 1
DMAC ACC:P,loc32,*XAR7/++	C = 1 on carry else C = 0
IMACL P,loc32,*XAR7/++	C = 1 on carry else C = 0
IMPYAL P,XT,loc32	C = 1 on carry else C = 0
IMPYSL P,XT,loc32	C = 0 on borrow else C = 1
INC loc16	C = 1 on carry else C = 0
LSL ACC,1..16	C = ACC(bit(32–shift))
LSL ACC,T	if(T == 0) C = 0 else C = ACC(bit(32–T))
LSL AX,1..16	C = AX(bit(16–shift))
LSL AX,T	if(T == 0) C = 0 else C = AX(bit(16–T))
LSL64 ACC:P,1..16	C = ACC(bit(32–shift))
LSL64 ACC:P,T	if(T == 0) C = 0 else C = ACC(bit(32–T))
LSLL ACC,T	if(T == 0) C = 0 else C = ACC(bit(32–T))
LSR AX,1..16	C = AX(bit(shift–1))
LSR AX,T	if(T == 0) C = 0 else C = AX(bit(T–1))
LSR64 ACC:P,1..16	C = P(bit(shift–1))



Table 2–8. Bits Affected by the C Bit (Continued)

Instruction	Affect of or Affect on C
LSR64 ACC:P,T	if(T == 0) C = 0 else C = P(bit(T–1))
LSRL ACC,T	if(T == 0) C = 0 else C = ACC(bit(T–1))
MAC P,loc16,*XAR7/++	C = 1 on carry else C = 0
MAC P,loc16,0:pma	C = 1 on carry else C = 0
MAX AX,loc16	for(AX – [loc16]) C = 0 on borrow else C = 1
MAXL ACC,loc32	for(ACC – [loc32]) C = 0 on borrow else C = 1
MIN AX,loc16	for(AX – [loc16]) C = 0 on borrow else C = 1
MINL ACC,loc32	for(ACC – [loc32]) C = 0 on borrow else C = 1
MOV loc16,AX,COND	C bit used as test condition
MOVA T,loc16	C = 1 on carry else C = 0
MOVAD T,loc16	C = 1 on carry else C = 0
MOVb loc16,#8bit,COND	C bit used as test condition
MOVL loc32,ACC,COND	C bit used as test condition
MOVs T,loc16	C = 0 on borrow else C = 1
MPYA P,loc16,#16bit	C = 1 on carry else C = 0
MPYA P,T,loc16	C = 1 on carry else C = 0
MPYS P,T,loc16	C = 0 on borrow else C = 1
NEG ACC	if( ACC == 0) C = 1 else C = 0
NEG AX	if(AX == 0) C = 1 else C = 0
NEG64 ACC:P	if( ACC:P == 0) C = 1 else C = 0

Table 2–8. Bits Affected by the C Bit (Continued)

Instruction	Affect of or Affect on C
NEGTC ACC	if(TC == 1) if(ACC == 0) C = 1 else C = 0
QMACL P,loc32,*XAR7/++	C = 1 on carry else C = 0
QMPYAL P,XT,loc32	C = 1 on carry else C = 0
QMPYSL P,XT,loc32	C = 0 on borrow else C = 1
ROL ACC	C ← (ACC << 1) ← C(before)
ROR ACC	C(before) → (ACC >> 1) → C
SAT ACC	C = 0
SAT64 ACC:P	C = 0
SB 8bitOff,COND	C bit used as test condition
SBBU ACC,loc16	ACC = ACC – ([loc16] + ~C) C = 0 on borrow else C = 1
SETC C	C = 1
SFR ACC,1..16	C = ACC(bit(shift–1))
SFR ACC,T	if(T == 0) C = 0 else C = ACC(bit(T–1))
SQRA loc16	C = 1 on carry else C = 0
SQRS loc16	C = 0 on borrow else C = 1
SUB ACC,#16bit << shift	C = 0 on borrow else C = 1
SUB ACC,loc16 << shift	if(shift == 16) C = 0 on borrow if(shift != 16) C = 0 on borrow else C = 1
SUB ACC,loc16 << T	C = 0 on borrow else C = 1
SUB AX,loc16	C = 0 on borrow else C = 1
SUB loc16,AX	C = 0 on borrow else C = 1
SUBB ACC,#8bit	C = 0 on borrow else C = 1

Table 2–8. Bits Affected by the C Bit (Continued)

Instruction	Affect of or Affect on C
SUBBL ACC,loc32	ACC = ACC – ([loc32] + ~C) C = 0 on borrow else C = 1
SUBCU ACC,loc16	for(ACC – [loc16]<<15) C = 0 on borrow else C = 1
SUBCUL ACC,loc32	for(ACC<<1 + P(31) – [loc32]) C = 0 on borrow else C = 1
SUBL ACC,loc32	C = 0 on borrow else C = 1
SUBL loc32,ACC	C = 0 on borrow else C = 1
SUBR loc16,AX	C = 0 on borrow else C = 1
SUBRL loc32,ACC	C = 0 on borrow else C = 1
SUBU ACC,loc16	C = 0 on borrow else C = 1
SUBUL ACC,loc32	C = 0 on borrow else C = 1
SUBUL P,loc32	C = 0 on borrow else C = 1
XB pma,COND	C bit used as test condition
XCALL pma,COND	C bit used as test condition
XMAC P,loc16,*(pma)	C = 1 on carry else C = 0
XMACD P,loc16,*(pma)	C = 1 on carry else C = 0
XRETC COND	C bit used as test condition

**TC**  
Bit 2

**Test/control flag.** This bit shows the result of a test performed by either the TBIT (test bit) instruction or the NORM (normalize) instruction.

The TBIT instruction tests a specified bit. When TBIT is executed, the TC bit is set if the tested bit is 1 or cleared if the tested bit is 0.

When a NORM instruction is executed, TC is modified as follows: If ACC holds 0, TC is set. If ACC does not hold 0, the CPU calculates the exclusive-OR of ACC bits 31 and 30, and then loads TC with the result.

This bit can be individually set and cleared by the SETC TC instruction and CLRC TC instruction, respectively. At reset, TC is cleared.

Table 2–9 lists the instructions that affect the TC bit. See the instruction set in Chapter 6 for a complete description of each instruction.

Table 2–9. Instructions That Affect the TC Bit

Instruction	Affect on the TC bit
ABSTC ACC	if( ACC < 0 ) TC = TC ^ 1
B 16bitOff,COND	TC bit used as test condition
BF 16bitOff,COND	TC bit used as test condition
CLRC TC	TC = 0
CMPR 0/1/2/3	TC = 0 0: if(AR(ARP) == AR0) TC = 1 1: if(AR(ARP) < AR0) TC = 1 2: if(AR(ARP) > AR0) TC = 1 3: if(AR(ARP) != AR0) TC = 1
CSB ACC	TC = N flag
MOV loc16,AX,COND	TC bit used as test condition
MOVB loc16,#8bit,COND	TC bit used as test condition
MOVL loc32,ACC,COND	TC bit used as test condition
NEGTC ACC	TC bit used as test condition
NORM ACC,XARn+/- NORM ACC,*ind	if(ACC != 0) TC = ACC(31) ^ ACC(30) else TC = 1
SB 8bitOff,COND	TC bit used as test condition
SBF 8bitOff,TC/NTC	TC bit used as test condition
SETC TC	TC = 1
TBIT loc16,#bit	TC = [loc16(bit)]
TBIT loc16,T	TC = [loc16(15-T)]
TCLR loc16,#bit	TC = [loc16(bit)]
TSET loc16,#bit	TC = [loc16(bit)]
XB pma,COND	TC bit used as test condition
XCALL pma,COND	TC bit used as test condition
XRETC COND	TC bit used as test condition

**OVM**  
Bit 1

**Overflow mode bit.** When ACC accepts the result of an addition or subtraction and the result causes an overflow, OVM determines how the CPU handles the overflow as follows:

- 0 Results overflow normally in ACC. The OVC reflects the overflow (see the description for the OVC on page 2-16)
- 1 ACC is filled with either its most positive or most negative value as follows:  
If ACC overflows in the positive direction (from 7FFF FFFF<sub>16</sub> to 8000 0000<sub>16</sub>), ACC is then filled with 7FFF FFFF<sub>16</sub>.  
If ACC overflows in the negative direction (from 8000 0000<sub>16</sub> to 7FFF FFFF<sub>16</sub>), ACC is then filled with 8000 0000<sub>16</sub>.

This bit can be individually set and cleared by the SETC OVM instruction and CLRC OVM instruction, respectively. At reset, OVM is cleared.

**SXM**  
Bit 0

**Sign-extension mode bit.** SXM affects the MOV, ADD, and SUB instructions that use a 16-bit value in an operation on the 32-bit accumulator. When the 16-bit value is loaded into (MOV), added to (ADD), or subtracted from (SUB) the accumulator, SXM determines whether the 16-bit value is sign extended during the operation as follows:

- 0 Sign extension is suppressed. (The 16-bit value is treated as unsigned.)
- 1 Sign extension is enabled. (The 16-bit value is treated as signed.)

For example:

```
ADD ACC, loc16 << shift
```

if SXM = 0, do not sign extend loc16 before adding to the 32-bit ACC.

if SXM = 1, sign extend loc16 before adding to the 32-bit ACC.

SXM also determines whether the accumulator is sign extended when it is shifted right by the SFR instruction. SXM does not affect instructions that shift the product register value; all right shifts of the product register value use sign extension.

This bit can be individually set and cleared by the SETC SXM instruction and CLRC SXM instruction, respectively. At reset, SXM is cleared. Table 2-10 lists the instructions that are affected by SXM. See Chapter 6 for more details on instructions.

Table 2–10. Instructions Affected by SXM

Instruction	Description
ADD ACC,#16bit << shift	Affected By SXM
ADD ACC,loc16 << shift	Affected By SXM
ADD ACC,loc16 << T	Affected By SXM
CLRC SXM	SXM = 0
MOV ACC,#16bit << shift	Affected By SXM
MOV ACC,loc16 << shift	Affected By SXM
MOV ACC,loc16 << T	Affected By SXM
SETC SXM	SXM = 1
SFR ACC,1..16	Affected By SXM
SFR ACC,T	Affected By SXM
SUB ACC,#16bit << shift	Affected By SXM
SUB ACC,loc16 << shift	Affected By SXM
SUB ACC,loc16 << T	Affected By SXM

## 2.4 Status Register ST1

The following figure shows the bit fields of status register ST1. All of these bit fields are modified in the decode 2 phase of the pipeline. Detailed descriptions of these bits follow the figure.

Figure 2–11. Bit Fields of Status Register 1 (ST1)

15			13		12	11	10		9	8	
ARP			XF		M0M1MAP	Reserved	OBJMODE		AMODE		
R/W-000			R/W-0		R/W-1	R/W-0	R/W-0		R/W-0		
7		6	5	4	3	2	1	0			
IDLESTAT	EALLOW	LOOP	SPA	VMAP	PAGE0	DBGM	INTM				
R-0	R/W-0	R-0	R/W-0	R/W-1	R/W-0	R/W-1	R/W-1				

**ARP**  
Bits 15–13

**Auxiliary register pointer.** This 3-bit field points to the current auxiliary register. This is one of the 32-bit auxiliary registers (XAR0–XAR7). The mapping of ARP values to auxiliary registers is as follows:

ARP	Selected Auxiliary Register
000	XAR0 (selected at reset)
001	XAR1
010	XAR2
011	XAR3
100	XAR4
101	XAR5
110	XAR6
111	XAR7

**XF**  
Bit 12

**XF status bit.** This bit reflects the current state of the XFS output signal, which is compatible to the C2XLP CPU. This bit is set by the "SETC XF" instruction. This bit is cleared by the "CLRC XF" instruction. The pipeline is not flushed when setting or clearing this bit using the given instructions. This bit can be saved and restored by interrupts and when restoring the ST1 register. This bit is set to 0 on reset.

**M0M1MAP**  
Bit 11

**M0 and M1 mapping mode bit.** The M0M1MAP bit should always remain set to 1 in the C28x object mode. This is the default value at reset. The M0M1MAP bit may be set low when operating in C27x-compatible mode. The effect of this bit, when low, is to swap the location of blocks M0 and M1 only in program space and to set the stack pointer default reset value to 0x000. C28x mode users should never set this bit to 0.

<b>Reserved</b> Bit 10	<b>Reserved.</b> This bit is reserved. Writes to this bit have no effect.
<b>OBJMODE</b> Bit 9	<b>Object compatibility mode bit.</b> This mode is used to select between C27x object mode (OBJMODE == 0) and C28x object mode (OBJMODE == 1) compatibility. This bit is set by the "C28OBJ" (or "SETC OBJMODE") instructions. This bit is cleared by the "C27OBJ" (or "CLRC OBJMODE") instructions. The pipeline is flushed when setting or clearing this bit using the given instructions. This bit is saved and restored by interrupts and when restoring the ST1 register. This bit is set to 0 on reset.
<b>AMODE</b> Bit 8	<p><b>Address mode bit.</b> This mode, in conjunction with the PAGE0 mode bit, is used to select the appropriate addressing mode decodes. This bit is set by the "LPADDR" ("SETC AMODE") instructions. This bit is cleared by the "C28ADDR" (or "CLRC AMODE") instructions. The pipeline is not flushed when setting or clearing this bit using the given instructions. This bit is saved and restored by interrupts and when restoring the ST1 register. This bit is set to 0 on reset.</p> <p>Note: Setting PAGE0 = AMODE = 1 will generate an illegal instruction trap ONLY for instructions that decode a memory or register addressing mode field (loc16 or loc32).</p>
<b>IDLESTAT</b> Bit 7	<p><b>IDLE status bit.</b> This read-only bit is set when the IDLE instruction is executed. It is cleared by any one of the following events:</p> <ul style="list-style-type: none"> <li><input type="checkbox"/> An interrupt is serviced.</li> <li><input type="checkbox"/> An interrupt is not serviced but takes the CPU out of the IDLE state.</li> <li><input type="checkbox"/> A valid instruction enters the instruction register (the register that holds the instruction currently being decoded).</li> <li><input type="checkbox"/> A device reset occurs.</li> </ul> <p>When the CPU services an interrupt, the current value of IDLESTAT is saved on the stack (when ST1 is saved on the stack), and then IDLESTAT is cleared. Upon return from the interrupt, IDLESTAT is not restored from the stack.</p>
<b>EALLOW</b> Bit 6	<p><b>Emulation access enable bit.</b> This bit, when set, enables access to emulation and other protected registers. Set this bit by using the EALLOW instruction and clear this bit by using the EDIS instruction. See the data sheet for a particular device to determine the registers that are protected.</p> <p>When the CPU services an interrupt, the current value of EALLOW is saved on the stack (when ST1 is saved on the stack), and then EALLOW is cleared. Therefore, at the start of an interrupt service routine (ISR), access to protected registers is disabled. If the ISR must access protected registers, it must include an EALLOW instruction. At the end of the ISR, EALLOW can be restored by the IRET instruction.</p>
<b>LOOP</b> Bit 5	<b>Loop instruction status bit.</b> LOOP is set when a loop instruction (LOOPNZ or LOOPZ) reaches the decode 2 phase of the pipeline. The loop instruction does not end until a specified condition is met. When the condition is met, LOOP is cleared. LOOP is a read-only bit; it is not affected by any instruction except a loop instruction.



When the CPU services an interrupt, the current value of LOOP is saved on the stack (when ST1 is saved on the stack), and then LOOP is cleared. Upon return from the interrupt, LOOP is not restored from the stack.

**SPA**  
Bits 4

**Stack pointer alignment bit.** SPA indicates whether the CPU has previously aligned the stack pointer to an even address by the ASP instruction:

- 0 The stack pointer has not been aligned to an even address.
- 1 The stack pointer has been aligned to an even address.

When the ASP (align stack pointer) instruction is executed, if the stack pointer (SP) points to an odd address, SP is incremented by 1 so that it points to an even address, and SPA is set. If SP already points to an even address, SP is not changed, but SPA is cleared. When the NASP (unalign stack pointer) instruction is executed, if SPA is 1, SP is decremented by 1 and SPA is cleared. If SPA is 0, SP is not changed.

At reset, SPA is cleared.

**VMAP**  
Bit 3

**Vector map bit.** VMAP determines whether the CPU interrupt vectors (including the reset vector) are mapped to the lowest or highest addresses in program memory:

- 0 CPU interrupt vectors are mapped to the bottom of program memory, addresses  $00\ 0000_{16}$ – $00\ 003F_{16}$ .
- 1 CPU interrupt vectors are mapped to the top of program memory, addresses  $3F\ FFC0_{16}$ – $3F\ FFFF_{16}$ .

On C28x designs, the VMAP signal is tied high internally, forcing the VMAP bit to be set high on a reset.

This bit can be individually set and cleared by the SETC VMAP instruction and CLRC VMAP instruction, respectively.

**PAGE0**  
Bit 2

**PAGE0 addressing mode configuration bit.** PAGE0 selects between two mutually-exclusive addressing modes: PAGE0 direct addressing mode and PAGE0 stack addressing mode. Selection of the modes is as follows:

- 0 PAGE0 stack addressing mode
- 1 PAGE0 direct addressing mode

---

**Note: Illegal Instruction Trap**

Setting PAGE0 = AMODE = 1 will generate an illegal instruction trap.

---

PAGE0 = 1 is included for compatibility with the C27x. the recommended operating mode for C28x is PAGE0 = 0.

This bit can be individually set and cleared by the SETC PAGE0 instruction and CLRC PAGE0 instruction, respectively. At reset, the PAGE0 bit is cleared (PAGE0 stack addressing mode is selected).

For details about the above addressing modes, see Chapter 5, *Addressing Modes*.

**DBGM**  
Bit 1

**Debug enable mask bit.** When DBGM is set, the emulator cannot access memory or registers in real time. The debugger cannot update its windows.

In the real-time emulation mode, if  $\text{DBGM} = 1$ , the CPU ignores halt requests or hardware breakpoints until DBGM is cleared. DBGM does not prevent the CPU from halting at a software breakpoint. One effect of this may be seen in real-time emulation mode. If you single-step an instruction in real time emulation mode and that instruction sets DBGM, the CPU continues to execute instructions until DBGM is cleared.

When you give the TI debugger the REALTIME command (to enter real-time mode), DBGM is forced to 0. Having  $\text{DBGM} = 0$  ensures that debug and test direct memory accesses (DT-DMAs) are allowed; memory and register values can be passed to the host processor for updating debugger windows.

Before the CPU executes an interrupt service routine (ISR), it sets DBGM. When  $\text{DBGM} = 1$ , halt requests from the host processor and hardware breakpoints are ignored. If you want to single-step through or set breakpoints in a non-time-critical ISR, you must add a CLRC DBGM instruction at the beginning of the ISR.

DBGM is primarily used in emulation to block debug events in time-critical portions of program code. DBGM enables or disables debug events as follows:

- 0 Debug events are enabled.
- 1 Debug events are disabled.

When the CPU services an interrupt, the current value of DBGM is saved on the stack (when ST1 is saved on the stack), and then DBGM is set. Upon return from the interrupt, DBGM is restored from the stack.

This bit can be individually set and cleared by the SETC DBGM instruction and CLRC DBGM instruction, respectively. DBGM is also set automatically during interrupt operations. At reset, DBGM is set. Executing the ABORTI (abort interrupt) instruction also sets DBGM.

**INTM**  
Bit 0

**Interrupt global mask bit.** This bit globally enables or disables all maskable CPU interrupts (those that can be blocked by software):

- 0 Maskable interrupts are globally enabled. To be acknowledged by the CPU, a maskable interrupt must also be locally enabled by the interrupt enable register (IER).
- 1 Maskable interrupts are globally disabled. Even if a maskable interrupt is locally enabled by the IER, it is not acknowledged by the CPU.

INTM has no effect on the nonmaskable interrupts, including a hardware reset or the hardware interrupt  $\overline{\text{NMI}}$ . In addition, when the CPU is halted in real-time emulation mode, an interrupt enabled by the IER and the DBGIER will be serviced even if INTM is set to disable maskable interrupts.

When the CPU services an interrupt, the current value of INTM is saved on the stack (when ST1 is saved on the stack), and then INTM is set. Upon return from the interrupt, INTM is restored from the stack.

This bit can be individually set and cleared by the SETC INTM instruction and CLRC INTM instruction, respectively. At reset, INTM is set. The value in INTM does not cause modification to the interrupt flag register (IFR), the interrupt enable register (IER), or the debug interrupt enable register (DBGIER).

## 2.5 Program Flow

The program control logic and program-address generation logic work together to provide proper program flow. Normally, the flow of a program is sequential: the CPU executes instructions at consecutive program-memory addresses. At times, a discontinuity is required; that is, a program must branch to a nonsequential address and then execute instructions sequentially at that new location. For this purpose, the '28x supports interrupts, branches, calls, returns, and repeats.

Proper program flow also requires smooth flow at the instruction level. To meet this need, the '28x has a protected pipeline and an instruction-fetch mechanism that attempts to keep the pipeline full.

### 2.5.1 Interrupts

Interrupts are hardware- or software-driven events that cause the CPU to suspend its current program sequence and execute a subroutine called an interrupt service routine. Interrupts are described in detail in Chapter 3.

### 2.5.2 Branches, Calls, and Returns

Branches, calls, and returns break the sequential flow of instructions by transferring control to another location in program memory. A branch only transfers control to the new location. A call also saves the return address (the address of the instruction following the call). Called subroutines or interrupt service routines are each concluded with a return instruction, which takes the return address from the stack or from XAR7 or RPC and places it into the program counter (PC).

The following branch instructions are conditional: B, BANZ, BAR, BF, SB, SBF, XBANZ, XCALL, and XRETC. They are executed only if a certain specified or predefined condition is met. For detailed descriptions of these instructions, see Chapter 6, *Assembly Language Instructions*.

### 2.5.3 Repeating a Single Instruction

The repeat (RPT) instruction allows the execution of a single instruction (N + 1) times, where N is specified as an operand of the RPT instruction. The instruction is executed once and then repeated N times. When RPT is executed, the repeat counter (RPTC) is loaded with N. RPTC is then decremented every time the repeated instruction is executed, until RPTC equals 0. For a description of RPT and a list of repeatable instructions, see Chapter 6, *Assembly Language Instructions*.

## 2.5.4 Instruction Pipeline

Each instruction passes through eight independent phases that form an instruction pipeline. At any given time, up to eight instructions may be active, each in a different phase of completion. Not all reads and writes happen in the same phases, but a pipeline-protection mechanism stalls instructions as needed to ensure that reads and writes to the same location happen in the order in which they are programmed.

To maximize pipeline efficiency, an instruction-fetch mechanism attempts to keep the pipeline full. Its role is to fill an instruction-fetch queue, which holds instructions in preparation for decoding and execution. The instruction-fetch mechanism fetches 32-bits at a time from program memory; it fetches one 32-bit instruction or two 16-bit instructions.

The instruction-fetch mechanism uses three program-address counters: the program counter (PC), the instruction counter (IC), and the fetch counter (FC). When the pipeline is full the PC will always point to the instruction in its decode 2 pipeline phase. The IC points to the next instruction to be processed. When the PC points to a 1-word instruction,  $IC = (PC+1)$ ; when the PC points to a 2-word instruction,  $IC = (PC+2)$ . The value in the FC is the address from which the next fetch is to be made.

The pipeline and the instruction-fetch mechanism are described in more detail in Chapter 4, *Pipeline*.

## 2.6 Multiply Operations

The C28x features a hardware multiplier that can perform 16-bit X 16-bit or 32-bit X 32-bit fixed-point multiplication. This functionality is enhanced by 16-bit X 16-bit multiply and accumulate (MAC), 32 X 32 MAC, and 16-bit X 16-bit dual MAC (DMAC) instructions. This section describes the components involved in each type of multiplication.

### 2.6.1 16-bit X 16-bit Multiplication

The C28x multiplier can perform a 16-bit X 16-bit multiplication to produce a signed or unsigned 32-bit product. Figure 2–12 shows the CPU components involved in this multiplication.

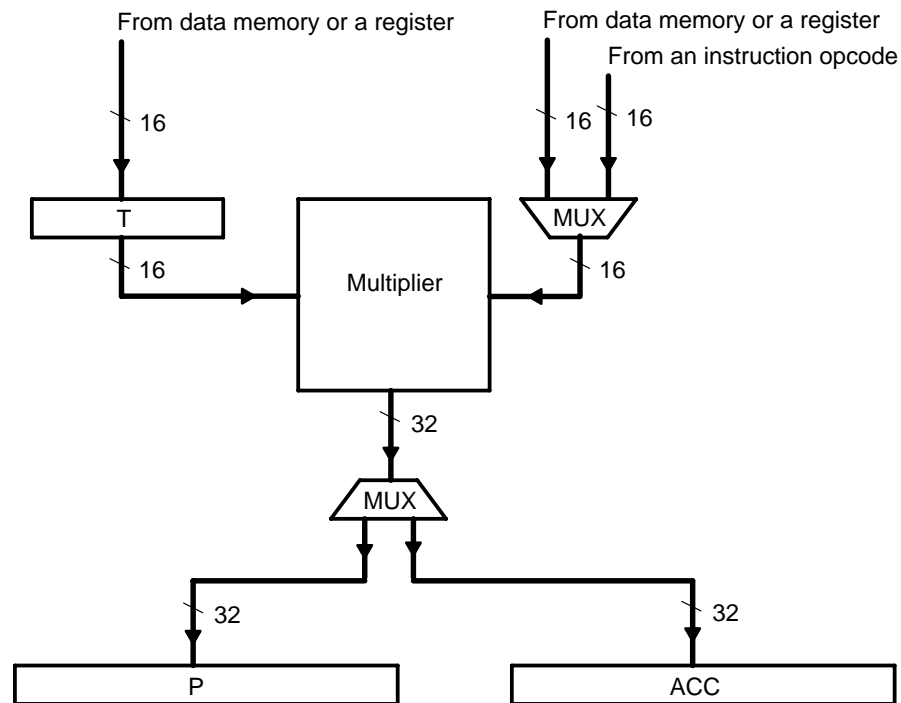
The multiplier accepts two 16-bit inputs:

- One input is from the upper 16 bits of the multiplicand register (T). Most 16 X 16 multiplication instructions require that you load T from a data-memory location or a register before you execute the instruction. However, the MAC and some versions of the MPY and MPYA instructions load T for you before the multiplication.
- The other input is from one of the following:
  - A data-memory location or a register (depending on which you specify in the multiply instruction).
  - An instruction opcode. Some C28x multiply instructions allow you to include a constant as an operation.

After the value has been multiplied by the second value, the 32-bit result is stored in one of two places, depending on the particular multiply instruction: the 32-bit product register (P) or the 32-bit accumulator (ACC).

One special 16-bit X 16-bit multiplication instruction takes two 32-bit input values as its operands. This instruction is the 16 X 16 DMAC instruction, which performs dual 16 X 16 MAC operations in one instruction. In this case, the ACC contains the result of multiplying and adding the upper word of the 32-bit operands. The P register contains the result of multiplying and adding the results of the lower word of the 32-bit operands.

Figure 2–12. Conceptual Diagram of Components Involved in 16 X16-Bit Multiplication



### 2.6.2 32-Bit X 32-Bit Multiplication

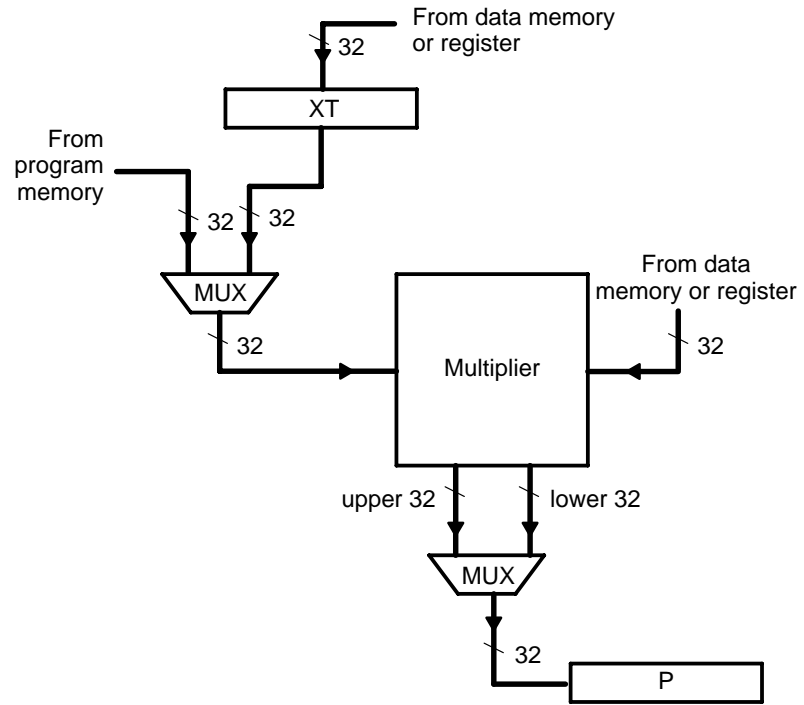
The C28x multiplier can also perform 32-bit by 32-bit multiplication. Figure 2–13 shows the CPU components involved in this multiplication. In this case, the multiplier accepts two 32-bit inputs:

- The first input is from one of the following:
  - A program memory location. Some C28x 32 X 32 multiply MAC-type instructions such as IMACL and QMACL take one data value directly from memory using the program-address bus.
  - The 32-bit multiplicand register (XT). Most 32 X 32-bit multiplication instructions require that you load XT from data memory or a register before you execute the instruction.
- A data-memory location or a register (depending on which you specify in the multiply instruction).

After the two values have been multiplied, 32 bits of the 64-bit result are stored in the product register (P). You can control which half is stored (upper 32 bits or lower 32 Bits) and whether the multiplication is signed or unsigned by the instruction used.

If you need support for larger data values, the 32 X 32 multiplication instructions can be combined to implement 32 X 32 = 64-bit or 64 X 64 = 128-bit math.

Figure 2–13. Conceptual Diagram of Components Involved in 32 X 32-Bit Multiplication





## 2.7 Shift Operations

The shifter holds 64 bits and accepts either a 16-bit, 32-bit, or 64-bit input value. When the input value has 16 bits, the value is loaded into the 16 least significant bits (LSBs) of the shifter. When the input value has 32 bits, the value is loaded into the 32 LSBs of the shifter. Depending on the instruction that uses the shifter, the output of the shifter may be all of its 64 bits or just its 16 LSBs.

When a value is shifted *right* by an amount *N*, the *N* LSBs of the value are lost and the bits to the left of the value are filled with all 0s or all 1s. If sign extension is specified, the bits to the left are filled with copies of the sign bit. If sign extension is not specified, the bits to the left are filled with 0s, or zero filled.

When a value is shifted *left* by an amount *N*, the bits to the right of the shifted value are zero filled. If the value has 16 bits and sign extension is specified, the bits to the left are filled with copies of the sign bit. If the value has 16 bits and sign extension is not specified, the bits to the left are zero filled. If the value has 32 bits, the *N* MSBs of the value are lost, and sign extension is irrelevant.

Table 2–11 lists the instructions that use the shifter and provides an illustration of the corresponding shifter operation. The table uses the following graphical symbols:

Shift left	This symbol represents the 32-bit shifter. The text inside the box indicates the direction of the shift.
0	This symbol indicates zero filling.
Sign	This symbol indicates sign extending.
SXM	This symbol indicates that the MSBs of the shifter depend on the sign-extension mode bit (SXM). If SXM = 0, the MSBs are zero filled after the shift. If SXM = 1, the MSBs are filled with the sign of the shifted value.
0/Sign	
C	This symbol indicates the carry bit (C).

For explanations of the instruction syntaxes listed in Table 2–11, see Chapter 6, *Assembly Language Instructions*.

Table 2–11. Shift Operations

Operation Type	Illustration
<p><b>Left shift of 16-bit value for ACC operation.</b> Syntaxes:</p> <p>ADD ACC, loc16 &lt;&lt; 0...16</p> <p>ADD ACC, #16Bit &lt;&lt; 0...15</p> <p>ADD ACC, loc16 &lt;&lt; T</p> <p>SUB ACC, loc16 &lt;&lt; 0...16</p> <p>SUB ACC, #16Bit &lt;&lt; 0...15</p> <p>SUB ACC, loc16 &lt;&lt; T</p> <p>MOV ACC, loc16 &lt;&lt; 0...16</p> <p>MOV ACC, #16Bit &lt;&lt; 0...15</p> <p>MOV ACC, loc16, &lt;&lt; T</p>	
<p><b>Store 16 LSBs of left-shifted ACC.</b></p> <p>Syntax:</p> <p>MOV loc16, ACC &lt;&lt; 1...8</p>	
<p><b>Store 16 MSBs of left-shifted ACC.</b></p> <p>Syntax:</p> <p>MOVH loc16, ACC &lt;&lt; 1...8</p> <p>Note: This instruction performs a single right shift by (16–shift1), where shift1 is a value from 0 to 8.</p>	
<p><b>Logical left shift of ACC.</b> The last bit to be shifted out fills the carry bit (C).</p> <p>Syntaxes:</p> <p>LSL ACC, 1...16</p> <p>LSL ACC, T (shift = T(3:0))</p> <p>LSL ACC, T (shift = T(4:0))</p> <p>Note: If T(3:0) = 0 or T(4:0) = 0, indicating a shift of 0, C is cleared.</p>	

Table 2–11. Shift Operations (Continued)

Operation Type	Illustration
<p><b>Logical left shift of AH or AL.</b> The last bit to be shifted out fills the carry bit (C).            Syntaxes:            LSL AX, 1...16            LSL AX, T (shift = T(3:0))            Note: If T(3:0) = 0, indicating a shift of 0, C is cleared.</p>	
<p><b>Right shift of ACC.</b> If SXM = 0, a logical shift is performed. If SXM = 1, an arithmetic shift is performed. The last bit to be shifted out fills the carry bit (C).            Syntaxes:            SFR ACC, 1...16            SFR ACC, T            Note: If T(3:0) = 0, indicating a shift of 0, C is cleared.</p>	
<p><b>Logical right shift of AH or AL.</b> The last bit to be shifted out fills the carry bit (C).            Syntaxes:            LSR AX, shift            LSR AX, T (shift = T(3:0))            ARLACC, T (shift = T(4:0))            Note: If T(4:0) = 0, indicating a shift of 0, C is cleared.</p>	
<p><b>Arithmetic right shift of AH or AL.</b> The last bit to be shifted out fills the carry bit (C).            Syntaxes:            ASR AX, shift            ASR AX, T            Note: If T(4:0) = 0, indicating a shift of 0, C is cleared.</p>	
<p><b>Rotate ACC left by 1 bit.</b> Bit 31 of ACC fills the carry bit (C). C fills bit 0 of ACC.            Syntax:            ROL ACC</p>	

Table 2–11. Shift Operations (Continued)

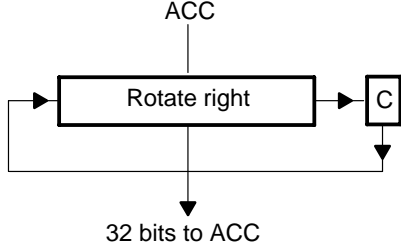
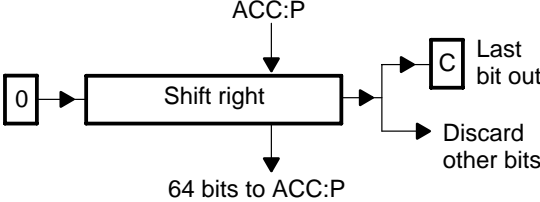
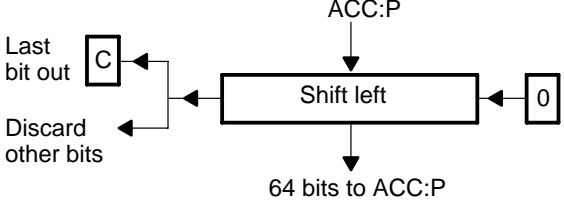
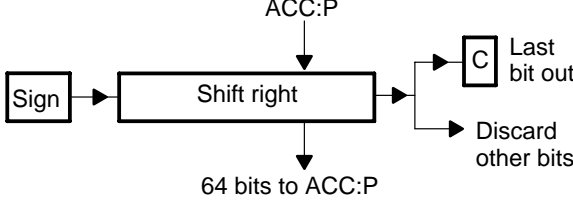
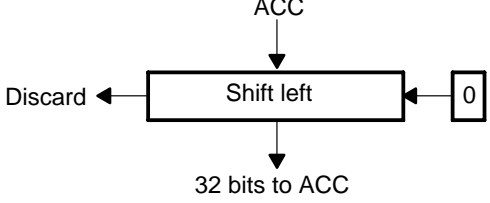
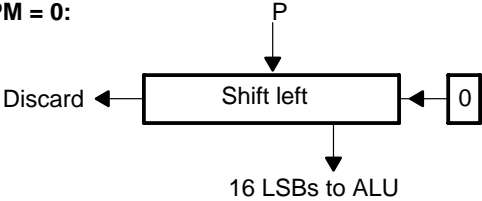
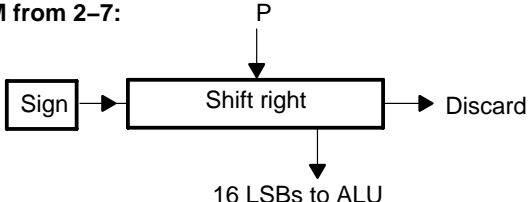
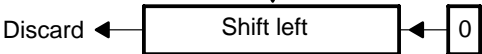
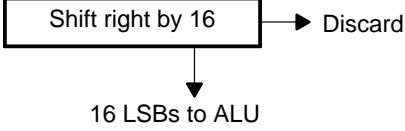
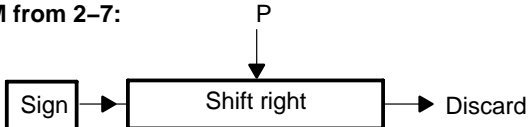
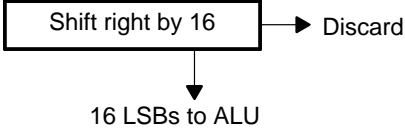
Operation Type	Illustration
<p><b>Rotate ACC right by 1 bit.</b> Bit 0 of ACC fills the carry bit (C). C fills bit 31 of ACC. Syntax: ROR ACC</p>	 <p>ACC</p> <p>Rotate right</p> <p>C</p> <p>32 bits to ACC</p>
<p><b>Logical right shift of ACC:P.</b> Syntaxes: LSR64 ACC:P, 1...16 LSR64, ACC:P, T shift = T(5:0)</p>	 <p>ACC:P</p> <p>Shift right</p> <p>0</p> <p>C Last bit out</p> <p>Discard other bits</p> <p>64 bits to ACC:P</p>
<p><b>Logical left shift of ACC:P.</b> Syntaxes: LSL64 ACC:P, 1...16 LSL64 ACC:P, T shift = T(5:0)</p>	 <p>ACC:P</p> <p>Shift left</p> <p>C Last bit out</p> <p>Discard other bits</p> <p>0</p> <p>64 bits to ACC:P</p>
<p><b>Arithmetic right shift of ACC:P.</b> Syntaxes: ASR64 ACC:P, 1...16 ASR64, ACC:P, T shift = T(5:0)</p>	 <p>ACC:P</p> <p>Shift right</p> <p>Sign</p> <p>C Last bit out</p> <p>Discard other bits</p> <p>64 bits to ACC:P</p>
<p><b>Conditional shift of ACC by 1 bit.</b> Syntaxes: NORM ACC, aux++ NORM ACC, aux-- SUBCU ACC, loc</p>	 <p>ACC</p> <p>Shift left</p> <p>Discard</p> <p>0</p> <p>32 bits to ACC</p>

Table 2-11. Shift Operations (Continued)

Operation Type	Illustration
<b>Shift of P as per PM bits. Syntaxes:</b>	<b>For PM = 0:</b>
ADD ACC, P	
SUB ACC, P	<b>For PM = 1: No shift</b>
CMP ACC, P	<b>For PM from 2-7:</b>
MAC P, loc, 0:pmem	
MOV ACC, P	
MOVA T, loc	
MOV P, T, loc	
MOVS T, loc	
MPYA P, loc, #16BitSigned	
MPYA P, T, loc	
MPYS P, T, loc	

Table 2–11. Shift Operations (Continued)

Operation Type	Illustration
<p><b>Store 16 LSBs of shifted P.</b> P is shifted as per the PM bits. The 16 LSBs of shifter are stored. Syntax: MOV <i>loc16</i>, P</p>	<p><b>For PM = 0:</b></p> 
	<p><b>For PM = 1:</b> No shift</p>
	<p><b>For PM from 2–7:</b></p> 
<p><b>Store 16 MSBs of shifted P.</b> P is shifted as per the PM bits. The result is shifted right by 16 so that its 16 MSBs are in the 16 LSBs of the shifter. 16 LSBs of shifter are stored. Syntax: MOVH <i>loc16</i>, P</p>	<p><b>For PM = 0:</b></p> <ol style="list-style-type: none"> <li>1) </li> <li>2) </li> </ol>
	<p><b>For PM = 1:</b> No shift</p>
	<p><b>For PM from 2–7:</b></p> <ol style="list-style-type: none"> <li>1) </li> <li>2) </li> </ol>

*This page intentionally left blank.*

---

This page intentionally left blank.

# CPU Interrupts and Reset

---

---

---

This chapter describes the available CPU interrupts and how they are handled by the CPU. It also explains how to control those interrupts that can be controlled through software. Finally, it describes how a hardware reset affects the CPU.

<b>Topic</b>	<b>Page</b>
3.1 CPU Interrupts Overview .....	3-2
3.2 CPU Interrupt Vectors and Priorities .....	3-4
3.3 Maskable Interrupts: $\overline{INT1}$ – $\overline{INT14}$ , DLOGINT, and RTOSINT .....	3-6
3.4 Standard Operation for Maskable Interrupts .....	3-11
3.5 Nonmaskable Interrupts .....	3-17
3.6 Illegal-Instruction Trap .....	3-22
3.7 Hardware Reset ( $\overline{RS}$ ) .....	3-23



### 3.1 CPU Interrupts Overview

Interrupts are hardware- or software-driven signals that cause the C28x CPU to suspend its current program sequence and execute a subroutine. Typically, interrupts are generated by peripherals or hardware devices that need to give data to or take data from the C28x (for example, A/D and D/A converters and other processors). Interrupts can also signal that a particular event has taken place (for example, a timer has finished counting).

On the C28x, interrupts can be triggered by software (the INTR, OR IFR, or TRAP instruction) or by hardware (a pin, an external peripheral, or on-chip peripheral/logic). If hardware interrupts are triggered at the same time, the C28x services them according to a set priority ranking.

Some 28x devices include a peripheral interrupt expansion (PIE) module that multiplexes interrupts from a number of peripherals into a single CPU interrupt. The PIE module provides additional control before an interrupt reaches the C28x CPU. See the *TMS320C8x System and Interrupts Reference Guide* (literature number SPRU078) for more details.

At the CPU level, each of the C28x interrupts, whether hardware or software, can be placed in one of the following two categories:

- Maskable interrupts.** These are interrupts that can be blocked (masked) or enabled (unmasked) through software.
- Nonmaskable interrupts.** These interrupts cannot be blocked. The C28x will immediately approve this type of interrupt and branch to the corresponding subroutine. All software-initiated interrupts are in this category.

The C28x handles interrupts in four main phases:

- 1) **Receive the interrupt request.** Suspension of the current program sequence must be requested by a software interrupt (from program code) or a hardware interrupt (from a pin or an on-chip device).
- 2) **Approve the interrupt.** The C28x must approve the interrupt request. If the interrupt is maskable, certain conditions must be met in order for the C28x to approve it. For nonmaskable hardware interrupts and for software interrupts, approval is immediate.
- 3) **Prepare for the interrupt service routine and save register values.** The main tasks performed in this phase are:
  - Complete execution of the current instruction and flush from the pipeline any instructions that have not reached the decode 2 phase.
  - Automatically save most of the current program context by saving the following registers to the stack: ST0, T, AL, AH, PL, PH, AR0, AR1, DP, ST1, DBGSTAT, PC, and IER.

- Fetch the interrupt vector and load it into the program counter (PC). For devices with a PIE module, the vector fetched will depend on the setting of the PIE enable and flag registers.
- 4) **Execute the interrupt service routine.** The C28x branches to its corresponding subroutine called an interrupt service routine (ISR). The C28x branches to the address (vector) you store at a predetermined vector location and executes the ISR you have written.

### 3.2 CPU Interrupt Vectors and Priorities

The C28x supports 32 CPU interrupt vectors, including the reset vector. Each vector is a 22-bit address that is the start address for the corresponding interrupt service routine (ISR). Each vector is stored in 32 bits at two consecutive addresses. The location at the lower address holds the 16 least significant bits (LSBs) of the vector. The location at the higher address holds the 6 most significant bits (MSBs) right-justified. When an interrupt is approved, the 22-bit vector is fetched, and the 10 MSBs at the higher address are ignored.

For devices with a PIE module, this table is re-mapped and expanded into the PIE vector table.

Table 3–1 lists the available CPU interrupt vectors and their locations. The addresses are shown in hexadecimal form. The table also shows the priority of each of the hardware interrupts.

Table 3–1. Interrupt Vectors and Priorities

Vector	Absolute Address (hexadecimal)		Hardware Priority	Description
	VMAP = 0	VMAP = 1 <sup>†</sup>		
RESET	00 0000	3F FFC0	1 (highest)	Reset
INT1	00 0002	3F FFC2	5	Maskable interrupt 1
INT2	00 0004	3F FFC4	6	Maskable interrupt 2
INT3	00 0006	3F FFC6	7	Maskable interrupt 3
INT4	00 0008	3F FFC8	8	Maskable interrupt 4
INT5	00 000A	3F FFCA	9	Maskable interrupt 5
INT6	00 000C	3F FFCC	10	Maskable interrupt 6
INT7	00 000E	3F FFCE	11	Maskable interrupt 7
INT8	00 0010	3F FFD0	12	Maskable interrupt 8
INT9	00 0012	3F FFD2	13	Maskable interrupt 9
INT10	00 0014	3F FFD4	14	Maskable interrupt 10
INT11	00 0016	3F FFD6	15	Maskable interrupt 11
INT12	00 0018	3F FFD8	16	Maskable interrupt 12
INT13	00 001A	3F FFDA	17	Maskable interrupt 13
INT14	00 001C	3F FFDC	18	Maskable interrupt 14

<sup>†</sup> For C28x catalog devices, VMAP = 1 at reset.

<sup>‡</sup> Interrupts DLOGINT and RTOSINT are generated by the emulation logic internal to the CPU.

Table 3–1. Interrupt Vectors and Priorities (Continued)

Vector	Absolute Address (hexadecimal)		Hardware Priority	Description
	VMAP = 0	VMAP = 1 <sup>†</sup>		
DLOGINT <sup>‡</sup>	00 001E	3F FFDE	19 (lowest)	Maskable data log interrupt
RTOSINT <sup>‡</sup>	00 0020	3F FFE0	4	Maskable real-time operating system interrupt
Reserved	00 0022	3F FFE2	2	Reserved
NMI	00 0024	3F FFE4	3	Nonmaskable interrupt
ILLEGAL	00 0026	3F FFE6	–	Illegal-instruction trap
USER1	00 0028	3F FFE8	–	User-defined software interrupt
USER2	00 002A	3F FFEA	–	User-defined software interrupt
USER3	00 002C	3F FFEC	–	User-defined software interrupt
USER4	00 002E	3F FFEE	–	User-defined software interrupt
USER5	00 0030	3F FFF0	–	User-defined software interrupt
USER6	00 0032	3F FFF2	–	User-defined software interrupt
USER7	00 0034	3F FFF4	–	User-defined software interrupt
USER8	00 0036	3F FFF6	–	User-defined software interrupt
USER9	00 0038	3F FFF8	–	User-defined software interrupt
USER10	00 003A	3F FFFA	–	User-defined software interrupt
USER11	00 003C	3F FFFC	–	User-defined software interrupt
USER12	00 003E	3F FFFE	–	User-defined software interrupt

<sup>†</sup> For C28x catalog devices, VMAP = 1 at reset.

<sup>‡</sup> Interrupts DLOGINT and RTOSINT are generated by the emulation logic internal to the CPU.

The vector table can be mapped to the top or bottom of program space, depending on the value of the vector map bit (VMAP) in status register ST1. (ST1 is described in section 2.4 on page 2-34.) If the VMAP bit is 0, the vectors are mapped beginning at address 00 0000<sub>16</sub>. If the VMAP bit is 1, the vectors are mapped beginning at address 3F FFC0<sub>16</sub>. Table 3–1 lists the absolute addresses for VMAP = 0 and VMAP = 1.

The VMAP bit can be set by the SETC VMAP instruction and cleared by the CLRC VMAP instruction. The reset value of VMAP is 1.

### 3.3 Maskable Interrupts: $\overline{INT1}$ – $\overline{INT14}$ , DLOGINT, and RTOSINT

$\overline{INT1}$ – $\overline{INT14}$  are 14 general-purpose interrupts. DLOGINT (the data log interrupt) and RTOSINT (the real-time operating system interrupt) are available for emulation purposes. These interrupts are supported by three dedicated registers: the CPU interrupt flag register (IFR), the CPU interrupt enable register (IER), and the CPU debug interrupt enable register (DBGIER).

The 16-bit IFR contains flag bits that indicate which of the corresponding interrupts are pending (waiting for approval from the CPU). The external input lines  $\overline{INT1}$ – $\overline{INT14}$  are sampled at every CPU clock cycle. If an interrupt signal is recognized, the corresponding bit in the IFR is set and latched. For DLOGINT or RTOSINT, a signal sent by the CPU on-chip analysis logic causes the corresponding flag bit to be set and latched. You can set one or more of the IFR bits at the same time by using the OR IFR instruction. More details about the IFR are given in section 3.3.1. The on-chip analysis resources are introduced in Chapter 7.

The interrupt enable register (IER) and the debug interrupt enable register (DBGIER) each contain bits for individually enabling or disabling the maskable interrupts. To enable one of the interrupts in the IER, you set the corresponding bit in the IER; to enable the same interrupt in the DBGIER, you set the corresponding bit in the DBGIER. The DBGIER indicates which interrupts can be serviced when the CPU is in the real-time emulation mode. The IER and the DBGIER are discussed more in section 3.3.2. Real-time mode is discussed in section 7.4.2 on page 7-9.

The maskable interrupts also share bit 0 in status register ST1. This bit, the interrupt global mask bit (INTM), is used to globally enable or globally disable these interrupts. When  $INTM = 0$ , these interrupts are globally enabled. When  $INTM = 1$ , these interrupts are globally disabled. You can set and clear INTM with the SETC INTM and CLRC INTM instructions, respectively. ST1 is described in section 2.4 on page 2-34.

After a flag has been latched in the IFR, the corresponding interrupt is not serviced until it is appropriately enabled by two of the following: the IER, the DBGIER, and the INTM bit. As shown in Table 3–2, the requirements for enabling the maskable interrupts depend on the interrupt-handling process used. In the standard process, which occurs in most circumstances, the DBGIER is ignored. When the C28x is in real-time emulation mode and the CPU is halted, a different process is used. In this special case, the DBGIER is used and the INTM bit is ignored. (If the DSP is in real-time mode and the CPU is running, the standard interrupt-handling process applies.)

Once an interrupt has been requested and properly enabled, the CPU prepares for and then executes the corresponding interrupt service routine. For a detailed description of this process, see section 3.4.

Table 3–2. Requirements for Enabling a Maskable Interrupt

Interrupt-Handling Process	Interrupt Enabled If ...
Standard	INTM = 0 and bit in IER is 1
DSP in real-time mode and CPU halted	Bit in IER is 1 and bit in DBGIER is 1

As an example of varying interrupt-enable requirements, suppose you want interrupt  $\overline{INT5}$  enabled. This corresponds to bit 4 in the IER and bit 4 in the DBGIER. Usually,  $\overline{INT5}$  is enabled if INTM = 0 and IER(4) = 1. In real-time emulation mode with the CPU halted,  $\overline{INT5}$  is enabled if IER(4) = 1 and DBGIER(4) = 1.

### 3.3.1 CPU Interrupt Flag Register (IFR)

Figure 3–1 shows the IFR. If a maskable interrupt is pending (waiting for approval from the CPU), the corresponding IFR bit is 1; otherwise, the IFR bit is 0. To identify pending interrupts, use the PUSH IFR instruction and then test the value on the stack. Use the OR IFR instruction to set IFR bits, and use the AND IFR instruction to clear pending interrupts. When a hardware interrupt is serviced, or when an INTR instruction is executed, the corresponding IFR bit is cleared. All pending interrupts are cleared by the AND IFR, #0 instruction or by a hardware reset.

#### Notes:

When an interrupt is requested by the TRAP instruction, if the corresponding IFR bit is set, the CPU does not clear it automatically. If an application requires that the IFR bit be cleared, the bit must be cleared in the interrupt service routine.

Figure 3–1. Interrupt Flag Register (IFR)

15	14	13	12	11	10	9	8
RTOSINT	DLOGINT	INT14	INT13	INT12	INT11	INT10	INT9
R/W–0	R/W–0	R/W–0	R/W–0	R/W–0	R/W–0	R/W–0	R/W–0
7	6	5	4	3	2	1	0
INT8	INT7	INT6	INT5	INT4	INT3	INT2	INT1
R/W–0	R/W–0	R/W–0	R/W–0	R/W–0	R/W–0	R/W–0	R/W–0

**Note:** R = Read access; W = Write access; value following dash (–) is value after reset.

Bits 15 and 14 of the IFR correspond to the interrupts RTOSINT and DLOGINT:

**RTOSINT    Real-time operating system interrupt flag**

Bit 15        RTOSINT = 0    RTOSINT is not pending.  
              RTOSINT = 1    RTOSINT is pending.

**DLOGINT    Data log interrupt flag**

Bit 14        DLOGINT = 0    DLOGINT is not pending.  
              DLOGINT = 1    DLOGINT is pending.

For bits INT1–INT14, the following general description applies:

**INTx        Interrupt x flag (x = 1, 2, 3, ..., or 14)**

Bit (x–1)    INTx = 0         $\overline{INTx}$  is not pending.  
              INTx = 1         $\overline{INTx}$  is pending.

### 3.3.2 CPU Interrupt Enable Register (IER) and CPU Debug Interrupt Enable Register (DBGIER)

Figure 3–2 shows the IER. To enable an interrupt, set its corresponding bit to 1. To disable an interrupt, clear its corresponding bit to 0. Two syntaxes of the MOV instruction allow you to read from the IER and write to the IER. In addition, the OR IER instruction enables you to set IER bits, and the AND IER instruction enables you to clear IER bits. When a hardware interrupt is serviced, or when an INTR instruction is executed, the corresponding IER bit is cleared. At reset, all the IER bits are cleared to 0, disabling all the corresponding interrupts.

**Note:**

When an interrupt is requested by the TRAP instruction, if the corresponding IER bit is set, the CPU does not clear it automatically. If an application requires that the IER bit be cleared, the bit must be cleared in the interrupt service routine.

Figure 3–2. Interrupt Enable Register (IER)

15	14	13	12	11	10	9	8
RTOSINT	DLOGINT	INT14	INT13	INT12	INT11	INT10	INT9
R/W–0	R/W–0	R/W–0	R/W–0	R/W–0	R/W–0	R/W–0	R/W–0
7	6	5	4	3	2	1	0
INT8	INT7	INT6	INT5	INT4	INT3	INT2	INT1
R/W–0	R/W–0	R/W–0	R/W–0	R/W–0	R/W–0	R/W–0	R/W–0

**Note:** R = Read access; W = Write access; value following dash (–) is value after reset.

**Note:**

When using the AND IER and OR IER instructions, make sure that they do not modify the state of bit 15 (RTOSINT) unless a real-time operating system is present.

Bits 15 and 14 of the IER enable or disable the interrupts RTOSINT and DLOGINT:

**RTOSINT Real-time operating system interrupt enable bit**

Bit 15      RTOSINT = 0      RTOSINT is disabled.  
                  RTOSINT = 1      RTOSINT is enabled.

**DLOGINT Data log interrupt enable bit**

Bit 14      DLOGINT = 0      DLOGINT is disabled.  
                  DLOGINT = 1      DLOGINT is enabled.

For bits INT1–INT14, the following general description applies:

**INT<sub>x</sub> Interrupt x enable bit (x = 1, 2, 3, ..., or 14)**

Bit (x–1)      INT<sub>x</sub> = 0       $\overline{INT_x}$  is disabled.  
                  INT<sub>x</sub> = 1       $\overline{INT_x}$  is enabled.

Figure 3–3 shows the DBGIER, which is used only when the CPU is halted in real-time emulation mode. An interrupt enabled in the DBGIER is defined as a *time-critical interrupt*. When the CPU is halted in real-time mode, the only interrupts that are serviced are time-critical interrupts that are also enabled in the IER. If the CPU is running in real-time emulation mode, the standard interrupt-handling process is used and the DBGIER is ignored.



As with the IER, you can read the DBGIER to identify enabled or disabled interrupts and write to the DBGIER to enable or disable interrupts. To enable an interrupt, set its corresponding bit to 1. To disable an interrupt, set its corresponding bit to 0. Use the PUSH DBGIER instruction to read from the DBGIER and the POP DBGIER instruction to write to the DBGIER. At reset, all the DBGIER bits are set to 0.

Figure 3–3. Debug Interrupt Enable Register (DBGIER)

15	14	13	12	11	10	9	8
RTOSINT	DLOGINT	INT14	INT13	INT12	INT11	INT10	INT9
R/W–0	R/W–0	R/W–0	R/W–0	R/W–0	R/W–0	R/W–0	R/W–0
7	6	5	4	3	2	1	0
INT8	INT7	INT6	INT5	INT4	INT3	INT2	INT1
R/W–0	R/W–0	R/W–0	R/W–0	R/W–0	R/W–0	R/W–0	R/W–0

**Note:** R = Read access; W = Write access; value following dash (–) is value after reset.

Bits 15 and 14 of the DBGIER enable or disable the interrupts RTOSINT and DLOGINT:

**RTOSINT Real-time operating system interrupt debug enable bit**

Bit 15      RTOSINT = 0      RTOSINT is disabled.  
               RTOSINT = 1      RTOSINT is enabled.

**DLOGINT Data log interrupt debug enable bit**

Bit 14      DLOGINT = 0      DLOGINT is disabled.  
               DLOGINT = 1      DLOGINT is enabled.

For bits INT1–INT14, the following general description applies:

**INTx Interrupt x debug enable bit (x = 1, 2, 3, ..., or 14)**

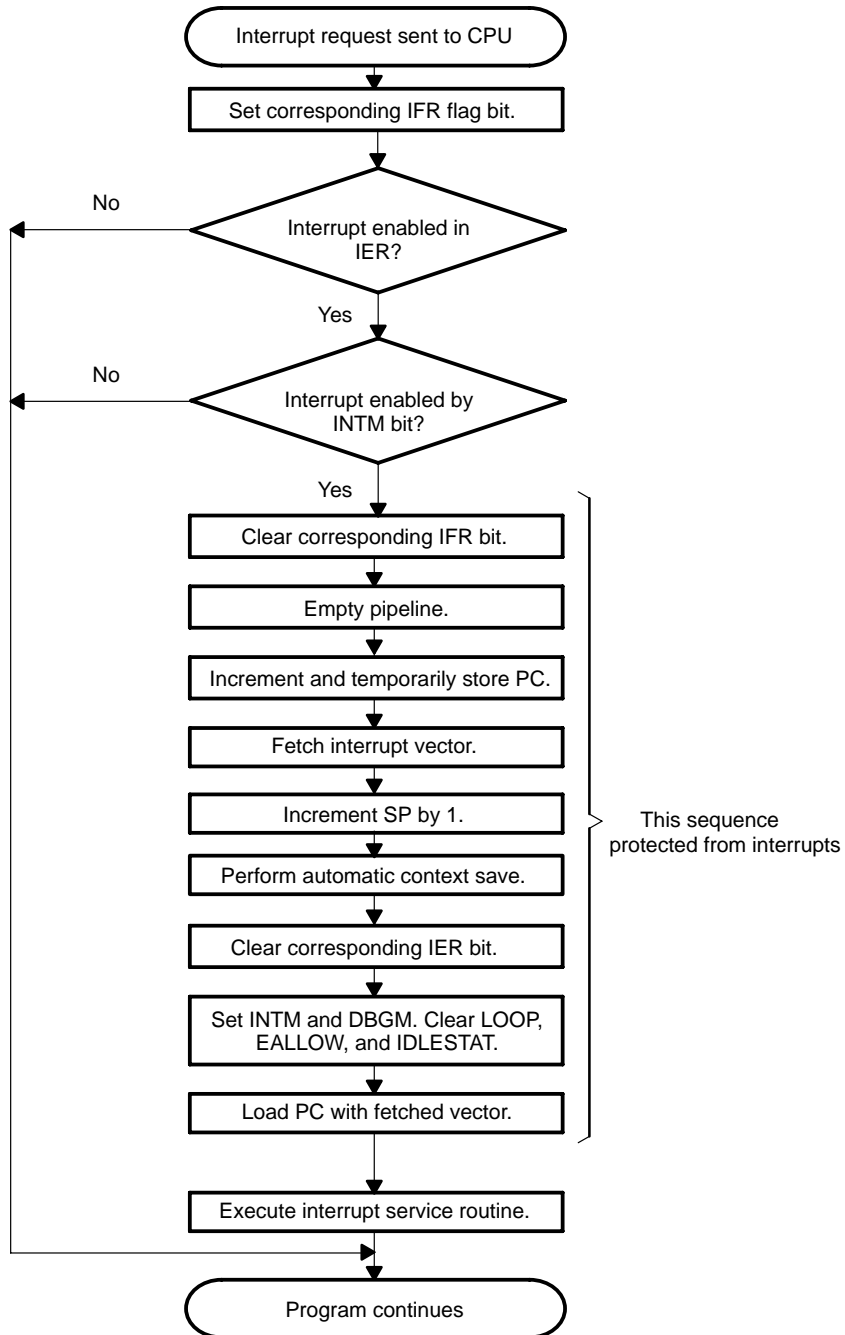
Bit (x–1)      INTx = 0       $\overline{INTx}$  is disabled.  
                   INTx = 1       $\overline{INTx}$  is enabled.

### 3.4 Standard Operation for Maskable Interrupts

The flow chart in Figure 3–4 shows the standard process for handling interrupts. Section 7.4.2 on page 7-9 contains information on handling interrupts when the DSP is in real-time mode and the CPU is halted. When more than one interrupt is requested at the same time, the C28x services them one after another according to their set priority ranking. See the priorities in Table 3–1 on page 3-4.

Figure 3–4 is not meant to be an exact representation of how an interrupt is handled. It is a conceptual model of the important events.

Figure 3–4. Standard Operation for CPU Maskable Interrupts



What following list explains the steps shown in Figure 3–4:

- 1) **Interrupt request sent to CPU.** One of the following events occurs:
  - One of the pins  $\overline{\text{INT1}}\text{--}\overline{\text{INT14}}$  is driven low by an external event, peripheral or PIE interrupt request..
  - The CPU emulation logic sends to the CPU a signal for DLOGINT or RTOSINT.
  - One of the interrupts  $\overline{\text{INT1}}\text{--}\overline{\text{INT14}}$ , DLOGINT, and RTOSINT is initiated by way of the OR IFR instruction.
- 2) **Set corresponding IFR flag bit.** When the CPU detects a valid interrupt in step 1, it sets and latches the corresponding flag in the interrupt flag register (IFR). This flag stays latched even if the interrupt is not approved by the CPU in step 3. The IFR is explained in detail in section 3.3.1.
- 3) **Is the interrupt enabled in IER? Is the interrupt enabled by INTM bit?**  
The CPU approves the interrupt only if the following conditions are true:
  - The corresponding bit in the IER is 1.
  - The INTM bit in ST1 is 0.

Once an interrupt has been enabled and then approved by the CPU, no other interrupts can be serviced until the CPU has begun executing the interrupt service routine for the approved interrupt (step 13). The IER is described in section 3.3.2. ST1 is described in section 2.4 on page 2-34.
- 4) **Clear corresponding IFR bit.** Immediately after the interrupt is approved, its IFR bit is cleared. If the interrupt signal is kept low, the IFR register bit will be set again. However, the interrupt is not immediately serviced again. The CPU blocks new hardware interrupts until the interrupt service routine (ISR) begins. In addition, the IER bit is cleared (in step 10) before the ISR begins; therefore, an interrupt from the same source cannot disturb the ISR until the IER bit is set again by the ISR.
- 5) **Empty the pipeline.** The CPU completes any instructions that have reached or passed their decode 2 phase in the instruction pipeline. Any instructions that have not reached this phase are flushed from the pipeline.
- 6) **Increment and temporarily store PC.** The PC is incremented by 1 or 2, depending on the size of the current instruction. The result is the *return address*, which is temporarily saved in an internal hold register. During the automatic context save (step 9), the return address is pushed onto the stack.

- 7) **Fetch interrupt vector.** The PC is filled with the address of the appropriate interrupt vector, and the vector is fetched from that location. To determine which vector address has been assigned to each of the interrupts, see section 3.2, *Interrupt Vectors*, on page 3-4 or, if your device uses a PIE module, see the System and Interrupts Reference Guide for your specific device.
- 8) **Increment SP by 1.** The stack pointer (SP) is incremented by 1 in preparation for the automatic context save (step 9). During the automatic context save, the CPU performs 32-bit accesses, and the CPU expects 32-bit accesses to be aligned to even addresses by the memory wrapper. Incrementing SP by 1 ensures that the first 32-bit access does not overwrite the previous stack value.
- 9) **Perform automatic context save.** A number of register values are saved automatically to the stack. These registers are saved in pairs; each pair is saved in a single 32-bit operation. At the end of each 32-bit save operation, the SP is incremented by 2. Table 3–3 shows the register pairs and the order in which they are saved. The CPU expects all 32-bit saves to be even-word aligned by the memory wrapper. As shown in the table, the SP is not affected by this alignment.

Table 3–3. Register Pairs Saved and SP Positions for Context Saves

Save Operation†	Register Pairs	Bit 0 of Storage Address	
		SP Starts at Odd Address	SP Starts at Even Address
		1 ← SP position before step 8	1
1st	ST0	0	0 ← SP position before step 8
	T	1	1
2nd	AL	0	0
	AH	1	1
3rd	PL‡	0	0
	PH	1	1
4th	AR0	0	0
	AR1	1	1
5th	ST1	0	0
	DP	1	1

Table 3–3. Register Pairs Saved and SP Positions for Context Saves (Continued)

Save Operation <sup>†</sup>	Register Pairs	Bit 0 of Storage Address	
		SP Starts at Odd Address	SP Starts at Even Address
6th	IER	0	0
	DBGSTAT <sup>§</sup>	1	1
7th	Return address (low half)	0	0
	Return address (high half)	1	1
		0 ← SP position after save	0
		1	1 ← SP position after save

<sup>†</sup> All registers are saved as pairs, as shown.

<sup>‡</sup> The P register is saved with 0 shift (CPU ignores current state of the product shift mode bits, PM, in status register 0).

<sup>§</sup> The DBGSTAT register contains special emulation information.

- 10) **Clear corresponding IER bit.** After the IER register is saved on the stack in step 9, the CPU clears the IER bit that corresponds to the interrupt being handled. This prevents reentry into the same interrupt. If you want to nest occurrences of the interrupt, have the ISR set that IER bit again.
- 11) **Set INTM and DBGM. Clear LOOP, EALLOW, and IDLESTAT.** All these bits are in status register ST1. By setting INTM to 1, the CPU prevents maskable interrupts from disturbing the ISR. If you wish to nest interrupts, have the ISR clear the INTM bit. By setting DBGM to 1, the CPU prevents debug events from disturbing time-critical code in the ISR. If you do not want debug events blocked, have the ISR clear DBGM.  
The CPU clears LOOP, EALLOW, and IDLESTAT so that the ISR operates within a new context.
- 12) **Load PC with fetched vector.** The PC is loaded with the interrupt vector that was fetched in step 7. The vector forces program control to the ISR.
- 13) **Execute interrupt service routine.** Here is where the CPU executes the program code you have prepared to handle the interrupt. A typical ISR is shown in Example 3–1.

Although a number of register values are saved automatically in step 10, if the ISR uses other registers, you may need to save the contents of these registers at the beginning of the ISR. These values must then be restored before the return from the ISR. The ISR in Example 3–1 saves and restores auxiliary registers AR1H:AR0H, XAR2–XAR7, and the temporary register XT.

If you want the ISR to inform a peripheral that the interrupt is being serviced, you can use the IACK instruction to send an interrupt acknowledge signal. The IACK instruction accepts a 16-bit constant as an operand. For a detailed description of the IACK instruction, see Chapter 6, *C28x Assembly Language Instructions*.

- 14) **Program continues.** If the interrupt is not approved by the CPU, the interrupt is ignored, and the program continues uninterrupted. If the interrupt is approved, its interrupt service routine is executed and the program continues where it left off (at the return address).

### Example 3–1. Typical ISR

#### C28x Full Context Save/Restore

```
INTX: ; 8 cycles
      PUSH      AR1H:AR0H ; 32-bit
      PUSH      XAR2      ; 32-bit
      PUSH      XAR3      ; 32-bit
      PUSH      XAR4      ; 32-bit
      PUSH      XAR5      ; 32-bit
      PUSH      XAR6      ; 32-bit
      PUSH      XAR7      ; 32-bit
      PUSH      XT        ; 32-bit
      ; +8 = 16 cycles
      .
      .
      .
      POP       XT
      POP       XAR7
      POP       XAR6
      POP       XAR5
      POP       XAR4
      POP       XAR3
      POP       XAR2
      POP       XAR1H:AR0H
      IRET
      ; 16 cycles
```

### 3.5 Nonmaskable Interrupts

Nonmaskable interrupts cannot be blocked by any of the enable bits (the INTM bit, the DBGM bit, and enable bits in the IFR, IER, or DBGIER). The C28x immediately approves this type of interrupt and branches to the corresponding interrupt service routine. There is one exception to this rule: When the CPU is halted in stop mode (an emulation mode), no interrupts are serviced. Stop mode is described in section 7.4.1 on page 7-7.

The C28x nonmaskable interrupts include:

- Software interrupts (the INTR and TRAP instructions).
- Hardware interrupt  $\overline{\text{NMI}}$
- Illegal-instruction trap
- Hardware reset interrupt ( $\overline{\text{RS}}$ )

The software interrupt instructions and  $\overline{\text{NMI}}$  are described in this section. The illegal-instruction trap and reset are described in sections 3.6 and 3.7, respectively.

#### 3.5.1 INTR Instruction

You can use the INTR instruction to initiate one of the following interrupts by name:  $\overline{\text{INT1}}\text{--}\overline{\text{INT14}}$ , DLOGINT, RTOSINT and  $\overline{\text{NMI}}$ . For example, you can execute the interrupt service routine for  $\overline{\text{INT1}}$  by using the following instruction:

```
INTR    INT1
```

Once an interrupt is initiated by the INTR instruction, how it is handled depends on which interrupt is specified:

- $\overline{\text{INT1}}\text{--}\overline{\text{INT14}}$ , DLOGINT, and RTOSINT.** These maskable interrupts have corresponding flag bits in the IFR. When a request for one of these interrupts is received at an external pin, the corresponding IFR bit is set and the interrupt must be enabled to be serviced. In contrast, when one of these interrupts is initiated by the INTR instruction, the IFR flag is not set, and the interrupt is serviced regardless of the value of any enable bits. However, in other respects, the INTR instruction and the hardware request are the same. For example, both clear the IFR bit that corresponds to the requested interrupt. For more details, see section 3.4 on page 3-11.
- $\overline{\text{NMI}}$ .** Because this interrupt is nonmaskable, a hardware request at a pin and a software request with the INTR instruction lead to the same events. These events are identical to those that take place during a TRAP instruction (see section 3.5.2).

Chapter 6, *C28x Assembly Language Instructions*, contains a detailed description of the INTR instruction.



### 3.5.2 TRAP Instruction

You can use the TRAP instruction to initiate any interrupt, including one of the user-defined software interrupts (see USER1–USER12 in Table 3–1 on page 3-4). The TRAP instruction refers to one of the 32 interrupts by a number from 0 to 31. For example, you can execute the interrupt service routine for  $\overline{\text{INT1}}$  by using the following instruction:

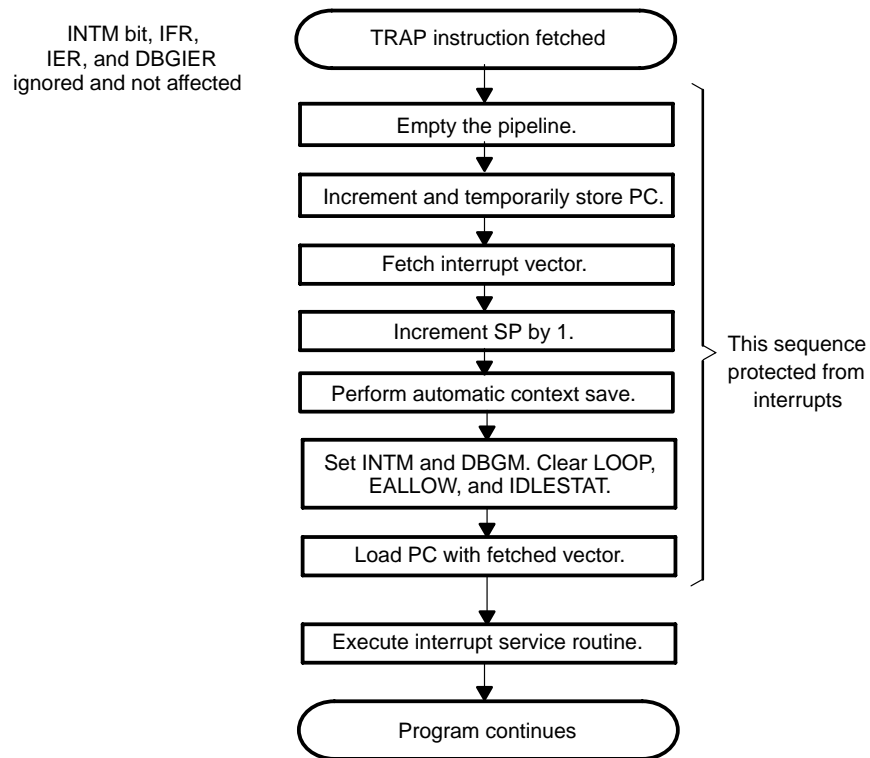
```
TRAP #1
```

Regardless of whether the interrupt has bits set in the IFR and IER, neither the IFR nor the IER is affected by this instruction. Figure 3–5 shows a functional flow chart for an interrupt initiated by the TRAP instruction. For more details about the TRAP instruction, see Chapter 6, *C28x Assembly Language Instructions*.

**Note:**

The TRAP #0 instruction does not initiate a full reset. It only forces execution of the interrupt service routine that corresponds to the RESET interrupt vector.

Figure 3–5. Functional Flow Chart for an Interrupt Initiated by the TRAP Instruction



The following lists explains the steps shown in Figure 3–5:

- 1) **TRAP instruction fetched.** The CPU fetches the TRAP instruction from program memory. The desired interrupt vector has been specified as an operand and is now encoded in the instruction word. At this stage, no other interrupts can be serviced until the CPU begins executing the interrupt service routine (step 9).
- 2) **Empty the pipeline.** The CPU completes any instructions that have reached or passed the decode 2 phase of the pipeline. Any instructions that have not reached this phase are flushed from the pipeline.
- 3) **Increment and temporarily store PC.** The PC is incremented by 1. This value is the *return address*, which is temporarily saved in an internal hold register. During the automatic context save (step 6), the return address is pushed onto the stack.
- 4) **Fetch interrupt vector.** The PC is set to point to the appropriate vector location (based on the VMAP bit and the interrupt), and the vector located at the PC address is loaded into the PC. (To determine which vector address has been assigned to each of the interrupts, see section 3.2, *Interrupt Vectors*, on page 3-4.)
- 5) **Increment SP by 1.** The stack pointer (SP) is incremented by 1 in preparation for the automatic context save (step 6). During the automatic context save, the CPU performs 32-bit accesses, which are aligned to even addresses. Incrementing SP by 1 ensures that the first 32-bit access will not overwrite the previous stack value.
- 6) **Perform automatic context save.** A number of register values are saved automatically to the stack. These registers are saved in pairs; each pair is saved in a single 32-bit operation. At the end of each 32-bit operation, the SP is incremented by 2. Table 3–3 shows the register pairs and the order in which they are saved. All 32-bit saves are even-word aligned. As shown in the table, the SP is not affected by this alignment.

Table 3–4. Register Pairs Saved and SP Positions for Context Saves

Save Operation†	Register Pairs	Bit 0 of Storage Address	
		SP Starts at Odd Address	SP Starts at Even Address
		1 ← SP position before step 5	1
1st	ST0	0	0 ← SP position before step 5
	T	1	1
2nd	AL	0	0
	AH	1	1
3rd	PL‡	0	0
	PH	1	1
4th	AR0	0	0
	AR1	1	1
5th	ST1	0	0
	DP	1	1
6th	IER	0	0
	DBGSTAT§	1	1
7th	Return address (low half)	0	0
	Return address (high half)	1	1
		0 ← SP position after save	0
		1	1 ← SP position after save

† All registers are saved as pairs, as shown.

‡ The P register is saved with 0 shift (CPU ignores current state of the product shift mode bits, PM, in status register 0).

§ The DBGSTAT register contains special emulation information.

- 7) **Set INTM and DBGM. Clear LOOP, EALLOW, and IDLESTAT.** All these bits are in status register ST1 (described in section 2.4 on page 2-34). By setting INTM to 1, the CPU prevents maskable interrupts from disturbing the ISR. If you wish to nest interrupts, have the ISR clear the INTM bit. By setting DBGM to 1, the CPU prevents debug events from disturbing time-critical code in the ISR. If you do not want debug events blocked, have the ISR clear DBGM.

The CPU clears LOOP, EALLOW, and IDLESTAT so that the ISR operates within a new context.

- 8) **Load PC with fetched vector.** The PC is loaded with the interrupt vector that was fetched in step 4. The vector forces program control to the ISR.
- 9) **Execute interrupt service routine.** The CPU executes the program code you have prepared to handle the interrupt. You may wish to have the interrupt service routine (ISR) save register values in addition to those saved in step 6. A typical ISR is shown in Example 3-1 on page 3-16.

If you want the ISR to inform external hardware that the interrupt is being serviced, you can use the IACK instruction to send an interrupt acknowledge signal. The IACK instruction accepts a 16-bit constant as an operand and drives this 16-bit value on the 16 least significant lines of the data-write bus, DWDB(15:0). For a detailed description of the IACK instruction, see Chapter 6, *C28x Assembly Language Instructions*.

- 10) **Program continues.** After the interrupt service routine is completed, the program continues where it left off (at the return address).

### 3.5.3 Hardware Interrupt $\overline{\text{NMI}}$

An interrupt can be requested by way the  $\overline{\text{NMI}}$  input pin, which must be driven low to initiate the interrupt. Although  $\overline{\text{NMI}}$  cannot be masked, there are some debug execution states in which  $\overline{\text{NMI}}$  is not serviced (see section 7.4, *Execution Control Modes*, on page 7-7). For more details on real-time mode, see section 7.4.2 on page 7-9. Once a valid request is detected on the  $\overline{\text{NMI}}$  pin, the CPU handles the interrupt in the same manner as shown for the TRAP instruction (see section 3.5.2).

### **3.6 Illegal-Instruction Trap**

Any one of the following events causes an illegal-instruction trap:

- An invalid instruction is decoded (this includes invalid addressing modes).
- The opcode value  $0000_{16}$  is decoded. This opcode corresponds to the ITRAP0 instruction.
- The opcode value  $FFFF_{16}$  is decoded. This opcode corresponds to the ITRAP1 instruction.
- A 32-bit operation attempts to use the @SP register addressing mode.
- Address mode setting  $AMODE=1$  and  $PAGE0=1$

An illegal-instruction trap cannot be blocked, not even during emulation. Once initiated, an illegal-instruction trap operates the same as a TRAP #19 instruction. The handling of an interrupt initiated by the TRAP instruction is described in section 3.5.2. As part of its operation, the illegal-instruction trap saves the return address on the stack. Thus, you can detect the offending address by examining this saved value. For more information about the TRAP instruction, see Chapter 6, *C28x Assembly Language Instructions*.

### 3.7 Hardware Reset ( $\overline{RS}$ )

When asserted, the reset input signal ( $\overline{RS}$ ) places the CPU into a known state. As part of a hardware reset, all current operations are aborted, the pipeline is flushed, and the CPU registers are reset as shown in Table 3–5. Then the RESET interrupt vector is fetched and the corresponding interrupt service routine is executed. For the reset condition of signals, see the data sheet for your particular C28x DSP. Also see the your data sheet for specific information on the process for resetting your DSP. Although  $\overline{RS}$  cannot be masked, there are some debug execution states in which  $\overline{RS}$  is not serviced (see section 7.4, *Execution Control Modes*, on page 7-7).

Table 3–5. Registers After Reset

Register	Bit(s)	Value After Reset	Comments
ACC	all	0000 0000 <sub>16</sub>	
XAR0	all	0000 0000 <sub>16</sub>	
XAR1	all	0000 0000 <sub>16</sub>	
XAR2	all	0000 0000 <sub>16</sub>	
XAR3	all	0000 0000 <sub>16</sub>	
XAR4	all	0000 0000 <sub>16</sub>	
XAR5	all	0000 0000 <sub>16</sub>	
XAR6	all	0000 0000 <sub>16</sub>	
XAR7	all	0000 0000 <sub>16</sub>	
DP	all	0000 <sub>16</sub>	DP points to data page 0.
IFR	16 bits	0000 <sub>16</sub>	There are no pending interrupts. All interrupts pending at the time of reset have been cleared.
IER	16 bits	0000 <sub>16</sub>	Maskable interrupts are disabled in the IER.
DBGIER	all	0000 <sub>16</sub>	Maskable interrupts are disabled in the DBGIER.

**Note:** The registers listed in this table are introduced in section 2.2, *CPU Registers*, on page 2-4.

Table 3–5. Registers After Reset (Continued)

Register	Bit(s)	Value After Reset	Comments
P	all	0000 0000 <sub>16</sub>	
PC	all	3F FFC0 <sub>16</sub>	PC is loaded with the reset interrupt vector at program-space address 00 0000 <sub>16</sub> or 3F FFC0 <sub>16</sub> .
RPC	all	0000 <sub>16</sub>	
SP	all	SP = 0x400	SP points to address 0400.
ST0	0: SXM	0	Sign extension is suppressed.
	1: OVM	0	Overflow mode is off.
	2: TC	0	
	3: C	0	
	4: Z	0	
	5: N	0	
	6: V	0	
	7–9: PM	000 <sub>2</sub>	The product shift mode is set to left-shift-by-1.
	10–15: OVC	00 0000 <sub>2</sub>	

**Note:** The registers listed in this table are introduced in section 2.2, *CPU Registers*, on page 2-4.

Table 3–5. Registers After Reset (Continued)

Register	Bit(s)	Value After Reset	Comments
ST1 <sup>‡</sup>	0: INTM	1	Maskable interrupts are globally disabled. They cannot be serviced unless the C28x is in real-time mode with the CPU halted.
	1: DBGM	1	Emulation accesses and events are disabled.
	2: PAGE0	0	PAGE0 stack addressing mode is enabled. PAGE0 direct addressing mode is disabled.
	3: VMAP	1	The interrupt vectors are mapped to program-memory addresses 3F FFC0 <sub>16</sub> –3F FFFF <sub>16</sub> .
	4: SPA	0	
	5: LOOP	0	
	6: EALLOW	0	Access to emulation registers is disabled.
	7: IDLESTAT	0	
	8: AMODE	0	C27x/C28x addressing mode
	9: OBJMODE	0	C27x object mode
	10: Reserved	0	
	11: M0M1MAP	1	

**Note:** The registers listed in this table are introduced in section 2.2, *CPU Registers*, on page 2-4.



Table 3–5. Registers After Reset (Continued)

Register	Bit(s)	Value After Reset	Comments
	12: XF	0	XFS output signal is low
	13–15: ARP	000 <sub>2</sub>	ARP points to AR0.
XT	all	0000 0000 <sub>32</sub>	

**Note:** The registers listed in this table are introduced in section 2.2, *CPU Registers*, on page 2-4.

# Pipeline

---

---

---

---

This chapter explains the operation of the C28x instruction pipeline. The pipeline contains hardware that prevents reads and writes at the same register or data-memory location from happening out of order. However, you can increase the efficiency of your programs if you take into account the operation of the pipeline. In addition, you should be aware of two types of pipeline conflicts the pipeline does not protect against and how you can avoid them (see section 4.5).

For more information about the instructions shown in examples throughout this chapter, see Chapter 6, *C28x Assembly Language Instructions*.

<b>Topic</b>	<b>Page</b>
<b>4.1 Pipelining of Instructions</b> .....	<b>4-2</b>
<b>4.2 Visualizing Pipeline Activity</b> .....	<b>4-7</b>
<b>4.3 Freezes in Pipeline Activity</b> .....	<b>4-10</b>
<b>4.4 Pipeline Protection</b> .....	<b>4-12</b>
<b>4.5 Avoiding Unprotected Operations</b> .....	<b>4-16</b>

## 4.1 Pipelining of Instructions

When executing a program, the C28x CPU performs these basic operations:

- Fetches instructions from program memory
- Decodes instructions
- Reads data values from memory or from CPU registers
- Executes instructions
- Writes results to memory or to CPU registers

For efficiency, the C28x performs these operations in eight independent phases. Reads from memory are designed to be pipelined in two stages, which correspond to the two pipeline phases used by the CPU for each memory-read operation. At any time, there can be up to eight instructions being carried out, each in a different phase of completion. Following are descriptions of the eight phases in the order they occur. The address and data buses mentioned in these descriptions are introduced in section 1.4.1 on page 1-9.

**Fetch 1 (F1)** In the fetch 1 (F1) phase, the CPU drives a program-memory address on the 22-bit program address bus, PAB(21:0).

**Fetch 2 (F2)** In the fetch 2 (F2) phase, the CPU reads from program memory by way of the program-read data bus, PRDB (31:0), and loads the instruction(s) into an instruction-fetch queue.

**Decode 1 (D1)** The C28x supports both 32-bit and 16-bit instructions and an instruction can be aligned to an even or odd address. The decode 1 (D1) hardware identifies instruction boundaries in the instruction-fetch queue and determines the size of the next instruction to be executed. It also determines whether the instruction is a legal instruction.

- Decode 2 (D2)** The decode 2 (D2) hardware requests an instruction from the instruction-fetch queue. The requested instruction is loaded into the instruction register, where decoding is completed. Once an instruction reaches the D2 phase, it runs to completion. In this pipeline phase, the following tasks are performed:
- If data is to be read from memory, the CPU generates the source address or addresses.
  - If data is to be written to memory, the CPU generates the destination address.
  - The address register arithmetic unit (ARAU) performs any required modifications to the stack pointer (SP) or to an auxiliary register and/or the auxiliary register pointer (ARP).
  - If a program-flow discontinuity (such as a branch or an illegal-instruction trap) is required, it is taken.
- Read 1 (R1)** If data is to be read from memory, the read 1 (R1) hardware drives the address(es) on the appropriate address bus(es).
- Read 2 (R2)** If data was addressed in the R1 phase, the read 2 (R2) hardware fetches that data by way of the appropriate data bus(es).
- Execute (E)** In the execute (E) phase, the CPU performs all multiplier, shifter, and ALU operations. This includes all the prime arithmetic and logic operations involving the accumulator and product register. For operations that involve reading a value, modifying it, and writing it back to the original location, the modification (typically an arithmetic or a logical operation) is performed during the E phase of the pipeline. Any CPU register values used by the multiplier, shifter, and ALU are read from the registers at the beginning of the E phase. A result that is to be written to a CPU register is written to the register at the end of the E phase.
- Write (W)** If a transferred value or result is to be written to memory, the write occurs in the write (W) phase. The CPU drives the destination address, the appropriate write strobes, and the data to be written. The actual storing, which takes at least one more clock cycle, is handled by memory wrappers or peripheral interface logic and is not visible as a part of the CPU pipeline.

Although every instruction passes through the eight phases, not every phase is active for a given instruction. Some instructions complete their operations in the decode 2 phase, others in the execute phase, and still others in the write phase. For example, instructions that do not read from memory perform no operations in the read phases, and instructions that do not write to memory perform no operation in the write phase.

Because different instructions perform modifications to memory and registers during different phases of their completion, an unprotected pipeline could lead to reads and writes at the same location happening out of the intended order. The CPU automatically adds inactive cycles to ensure that these reads and writes happen as intended. For more details about pipeline protection, see section 4.4 on page 4-12.

#### 4.1.1 Decoupled Pipeline Segments

The fetch 1 through decode 1 (F1–D1) hardware acts independently of the decode 2 through write (D2–W) hardware. This allows the CPU to continue fetching instructions when the D2–W phases are halted. It also allows fetched instructions to continue through their D2–W phases when fetching of new instructions is delayed. Events that cause portions of the pipeline to halt are described in section 4.3.

Instructions in their fetch 1, fetch 2, and decode 1 phases are discarded if an interrupt or other program-flow discontinuity occurs. An instruction that reaches its decode 2 phase always runs to completion before any program-flow discontinuity is taken.

#### 4.1.2 Instruction-Fetch Mechanism

Certain branch instructions perform prefetching. The first few instructions of the branch destination will be fetched but not allowed to reach D2 until it is known whether the discontinuity will be taken. The instruction-fetch mechanism is the hardware for the F1 and F2 pipeline phases. During the F1 phase, the mechanism drives an address on the program address bus (PAB). During the F2 phase, it reads from the program-read data bus (PRDB). While an instruction is read from program memory in the F2 phase, the address for the next fetch is placed on the program address bus (during the next F1 phase).

The instruction-fetch mechanism contains an instruction-fetch queue of four 32-bit registers. During the F2 phase, the fetched instruction is added to the queue, which behaves like a first-in, first-out (FIFO) buffer. The first instruction in the queue is the first to be executed. The instruction-fetch mechanism performs 32-bit fetches until the queue is full. When a program-flow discontinuity

(such as a branch or an interrupt) occurs, the queue is emptied. When the instruction at the bottom of the queue reaches its D2 phase, that instruction is passed to the instruction register for further decoding.

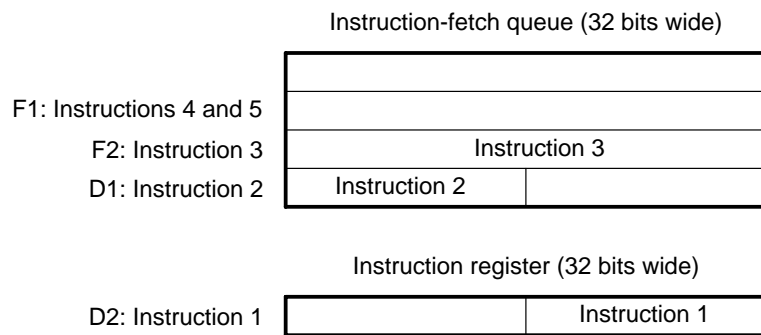
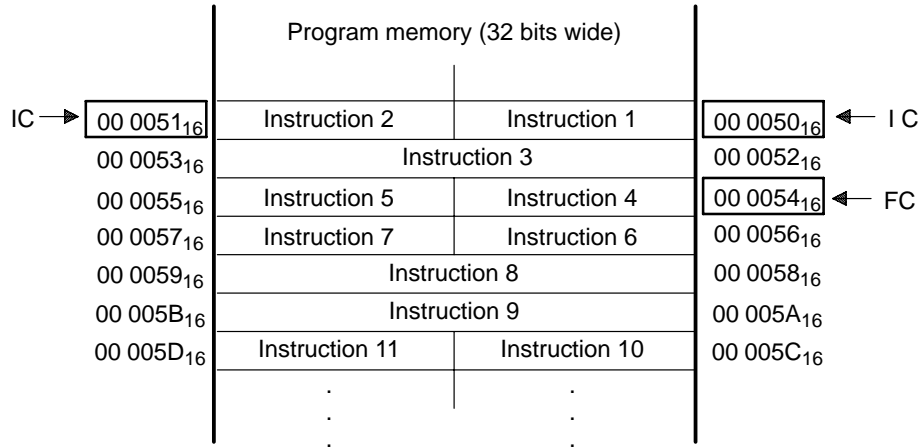
### 4.1.3 Address Counters FC, IC, and PC

Three program-address counters are involved in the fetching and execution of instructions:

- ❑ **Fetch counter (FC).** The fetch counter contains the address that is driven on the program address bus (PAB) in the F1 pipeline phase. The CPU continually increments the FC until the queue is full or the queue is emptied by a program-flow discontinuity. Generally, the FC holds an even address and is incremented by 2, to accommodate 32-bit fetches. The only exception to this is when the code after a discontinuity begins at an odd address. In this case, the FC holds the odd address. After performing a 16-bit fetch at the odd address, the CPU increments the FC by 1 and resumes 32-bit fetching at even addresses.
- ❑ **Instruction counter (IC).** After the D1 hardware determines the instruction size (16-bit or 32-bit), it fills the instruction counter (IC) with the address of the next instruction to undergo D2 decoding. On an interrupt or call operation, the IC value represents the return address, which is saved to the stack, to auxiliary register XAR7, or to RPC.
- ❑ **Program counter (PC).** When a new address is loaded into the IC, the previous IC value is loaded into the PC. The program counter (PC) always contains the address of the instruction that has reached its D2 phase.

Example 4–1 shows the relationship between the pipeline and the address counters. Instruction 1 has reached its D2 phase (it has been passed to the instruction register). The PC points to the address from which instruction 1 was taken ( $00\ 0050_{16}$ ). Instruction 2 has reached its D1 phase and will be executed next (assuming no program-flow discontinuity flushes the instruction-fetch queue). The IC points to the address from which instruction 2 was taken ( $00\ 0051_{16}$ ). Instruction 3 is in its F2 phase. It has been transferred to the instruction-fetch queue but has not been decoded. Instructions 4 and 5 are each in their F1 phase. The FC address ( $00\ 0054_{16}$ ) is being driven on the PAB. During the next 32-bit fetch, Instructions 4 and 5 will be transferred from addresses  $00\ 0054_{16}$  and  $00\ 0055_{16}$  to the queue.

Example 4–1. Relationship Between Pipeline and Address Counters FC, IC, and PC



The remainder of this document refers almost exclusively to the PC. The FC and the IC are visible in only limited ways. For example, when a call is executed or an interrupt is initiated, the IC value is saved to the stack or to auxiliary register XAR7.

## 4.2 Visualizing Pipeline Activity

Consider Example 4–2, which lists eight instructions, I1–I8, and shows a diagram of the pipeline activity for those instructions. The F1 column shows addresses and the F2 column shows the instruction opcodes read at those addresses. During an instruction fetch, 32 bits are read, 16 bits from the specified address and 16 bits from the following address. The D1 column shows instructions being isolated in the instruction-fetch queue, and the D2 column indicates address generation and modification of address registers. The Instruction column shows the instructions that have reached the D2 phase. The R1 column shows addresses, and the R2 column shows the data values being read from those addresses. In the E column, the diagram shows results being written to the low half of the accumulator (AL). In the W column, address and a data values are driven simultaneously on the appropriate memory buses. For example, in the last active W phase of the diagram, the address  $00\ 0205_{16}$  is driven on the data-write address bus (DWAB), and the data value  $1234_{16}$  is driven on the data-write data bus (DWDB).

The highlighted blocks in Example 4–2 indicate the path taken by the instruction `ADD AL,*AR0++`. That path can be summarized as follows:

Phase	Activity Shown
F1	Drive address $00\ 0042_{16}$ on the program address bus (PAB).
F2	Read the opcodes F347 and F348 from addresses $00\ 0042_{16}$ and $00\ 0043_{16}$ , respectively.
D1	Isolate F348 in the instruction-fetch queue.
D2	Use $XAR0 = 0066_{16}$ to generate source address $0000\ 0066_{16}$ and then increment $XAR0$ to $0067_{16}$ .
R1	Drive address $00\ 0066_{16}$ on the data-read data bus (DRDB).
R2	Read the data value 1 from address $0000\ 0066_{16}$ .
E	Add 1 to content of AL ( $1230_{16}$ ) and store result ( $1231_{16}$ ) to AL.
W	No activity



Example 4–2. Diagramming Pipeline Activity

Address	Opcode	Instruction	Initial Values
00 0040	F345	I1: MOV DP,#VarA ; DP = page that has VarA.	VarA address = 00 0203
00 0041	F346	I2: MOV AL,@VarA ; Move content of VarA to AL.	VarA = 1230
00 0042	F347	I3: MOVB AR0,#VarB ; AR0 points to VarB.	VarB address = 00 0066
00 0043	F348	I4: ADD AL,*XAR0++ ; Add content of VarB to ; AL, and add 1 to XAR0.	VarB = 0001 (VarB + 1) = 0003
00 0044	F349	I5: MOV @VarC,AL ; Replace content of VarC ; with content of AL.	(VarB + 2) = 0005 VarC address = 00 0204
00 0045	F34A	I6: ADD AL,*XAR0++ ; Add content of (VarB + 1) ; to AL, and add 1 to XAR0.	VarD address = 00 0205
00 0046	F34B	I7: MOV @VarD,AL ; Replace content of VarD ; with content of AL.	
00 0047	F34C	I8: ADD AL,*XAR0 ; Add content of (VarB + 2) ; to AL.	

F1	F2	D1	Instruction	D2	R1	R2	E	W
00 0040								
	F346:F345							
00 0042		F345						
	F348:F347	F346	I1: MOV DP,#VarA	DP = 8				
00 0044		F347	I2: MOV AL,@VarA	Generate VarA address	-			
	F34A:F349	F348	I3: MOVB XAR0,#Var B	XAR0 = 66	00 0203	-		
00 0046		F349	I4: ADD AL,*XAR0+ +	XAR0 = 67	-	1230	-	
	F34C:F34B	F34A	I5: MOV @VarC,AL	Generate VarC address	00 0066	-	AL=1230	-
		F34B	I6: ADD AL,*XAR0+ +	XAR0 = 68	-	0001	-	-
		F34C	I7: MOV @VarD,AL	Generate VarD address	00 0067	-	AL=1231	-
			I8: ADD AL,*XAR0	XAR0 = 68	-	0003	-	-
					00 0068	-	AL=1234	00 0204 1231
						0005	-	-
							AL=1239	00 0205 1234

F1	F2	D1	Instruction	D2	R1	R2	E	W
								-

**Note:** The opcodes shown in the F2 and D1 columns were chosen for illustrative purposes; they are not the actual opcodes of the instructions shown.

The pipeline activity in Example 4–2 can also be represented by the simplified diagram in Example 4–3. This type of diagram is useful if your focus is on the path of each instruction rather than on specific pipeline events. In cycle 8, the pipeline is full: there is an instruction in every pipeline phase. Also, the effective execution time for each of these instructions is one cycle. Some instructions finish their activity at the D2 phase, some at the E phase, and some at the W phase. However, if you choose one phase as a reference, you can see that each instruction is in that phase for one cycle.

*Example 4–3. Simplified Diagram of Pipeline Activity*

F1	F2	D1	D2	R1	R2	E	W	Cycle
I1								1
I2	I1							2
I3	I2	I1						3
I4	I3	I2	I1					4
I5	I4	I3	I2	I1				5
I6	I5	I4	I3	I2	I1			6
I7	I6	I5	I4	I3	I2	I1		7
I8	I7	I6	I5	I4	I3	I2	I1	8
	I8	I7	I6	I5	I4	I3	I2	9
		I8	I7	I6	I5	I4	I3	10
			I8	I7	I6	I5	I4	11
				I8	I7	I6	I5	12
					I8	I7	I6	13
						I8	I7	14
							I8	15

### 4.3 Freezes in Pipeline Activity

This section describes the two causes for freezes in pipeline activity:

- Wait states
- An instruction-not-available condition

#### 4.3.1 Wait States

When the CPU requests a read from or write to a memory device or peripheral device, that device may take more time to finish the data transfer than the CPU allots by default. Each device must use one of the CPU *ready signals* to insert wait states into the data transfer when it needs more time. The CPU has three independent sets of ready signals: one set for reads from and writes to program space, a second set for reads from data space, and a third set for writes to data space. Wait-state requests freeze a portion of the pipeline if they are received during the F1, R1, or W phase of an instruction:

- Wait states in the F1 phase.** The instruction-fetch mechanism halts until the wait states are completed. This halt effectively freezes activity for instructions in their F1, F2, and D1 phases. However, because the F1–D1 hardware and the D2–W hardware are decoupled, instructions that are in their D2–W phases continue to execute.
- Wait states in the R1 phase.** All D2–W activities of the pipeline freeze. This is necessary because subsequent instructions can depend on the data-read taking place. Instruction fetching continues until the instruction-fetch queue is full or a wait-state request is received during an F1 phase.
- Wait states in the W phase.** All D2–W activity in the pipeline freezes. This is necessary because subsequent instructions may depend on the write operation happening first. Instruction fetching continues until the instruction-fetch queue is full or a wait-state request is received during an F1 phase.

#### 4.3.2 Instruction-Not-Available Condition

The D2 hardware requests an instruction from the instruction-fetch queue. If a new instruction has been fetched and has completed its D1 phase, the instruction is loaded into the instruction register for more decoding. However, if a new instruction is *not* waiting in the queue, an instruction-not-available condition exists. Activity in the F1–D1 hardware continues. However, the activity in the D2–W hardware ceases until a new instruction is available.

One time that an instruction-not-available condition will occur is when the first instruction after a discontinuity is at an odd address and has 32 bits. A *discontinuity* is a break in sequential program flow, generally caused by a branch, a call, a return, or an interrupt. When a discontinuity occurs, the instruction-fetch queue is emptied, and the CPU branches to a specified address. If the specified address is an odd address, a 16-bit fetch is performed at the odd address, followed by 32-bit fetches at subsequent even addresses. Thus, if the first instruction after a discontinuity is at an odd address and has 32 bits, two fetches are required to get the entire instruction. The D2–W hardware ceases until the instruction is ready to enter the D2 phase.

To avoid the delay where possible, you can begin each block of code with one or two (preferably two) 16-bit instructions:

```
FunctionA:
    16-bit instruction    ; First instruction
    16-bit instruction    ; Second instruction
    32-bit instruction    ; 32-bit instructions can start here
    .
    .
    .
```

If you choose to use a 32-bit instruction as the first instruction of a function or subroutine, you can prevent a pipeline delay only by making sure the instruction begins at an even address.

## 4.4 Pipeline Protection

Instructions are being executed in parallel in the pipeline, and different instructions perform modifications to memory and registers during different phases of completion. In an unprotected pipeline, this could lead to pipeline conflicts—reads and writes at the same location happening out of the intended order. However, the C28x pipeline has a mechanism that automatically protects against pipeline conflicts. There are two types of pipeline conflicts that can occur on the C28x:

- Conflicts during reads and writes to the same data-space location
- Register conflicts

The pipeline prevents these conflicts by adding inactive cycles between instructions that would cause the conflicts. Sections 4.4.1 and 4.4.2 explain the circumstances under which these pipeline-protection cycles are added and tells how to avoid them, so that you can reduce the number of inactive cycles in your programs.

### 4.4.1 Protection During Reads and Writes to the Same Data-Space Location

Consider two instructions, A and B. Instruction A writes a value to a memory location during its W phase. Instruction B must read that value from the same location during its R1 and R2 phases. Because the instructions are being executed in parallel, it is possible that the R1 phase of instruction B could occur before the W phase of instruction A. Without pipeline protection, instruction B could read too early and fetch the wrong value. The C28x pipeline prevents that read by holding instruction B in its D2 phase until instruction A is finished writing.

Example 4–4 shows a conflict between two instructions that are accessing the same data-memory location. The pipeline activity shown is for an *unprotected* pipeline. For convenience, the F1–D1 phases are not shown. I1 writes to VarA during cycle 5. Data memory completes the store in cycle 6. I2 should not read the data-memory location any sooner than cycle 7. However, I2 performs the read during cycle 4 (three cycles too early). To prevent this kind of conflict, the pipeline-protection mechanism would hold I2 in the D2 phase for 3 cycles. During these *pipeline-protection cycles*, no new operations occur.

**Example 4–4. Conflict Between a Read From and a Write to Same Memory Location**

```
I1:  MOV @VarA,AL ; Write AL to data-memory location
I2:  MOV AH,@VarA ; Read same location, store value in AH
```

DZ	KI	RZ	E	W	Cycle
I1					1
I2	I1				2
I2		I1			3
I2			I1		4
I2				I1	5
	I2				6
		I2			7
			I2		8

You can reduce or eliminate these types of pipeline-protection cycles if you can take other instructions in your program and insert them between the instructions that conflict. Of course, the inserted instructions must not cause conflicts of their own or cause improper execution of the instructions that follow them. For example, the code in Example 4–4 could be improved by moving a CLRC instruction to the position between the MOV instructions (assume that the instructions following CLRC SXM operate correctly with SXM = 0):

```
I1:  MOV @VarA,AL ; Write AL to data-memory location
      CLRC SXM      ; SXM = 0 (sign extension off)
I2:  MOV AH,@VarA ; Read same location, store value in AH
```

Inserting the CLRC instruction between I1 and I2 reduces the number of pipeline-protection cycles to two. Inserting two more instructions would remove the need for pipeline protection. As a general rule, if a read operation occurs within three instructions from a write operation to the same memory location, the pipeline protection mechanism adds at least one inactive cycle.

**4.4.2 Protection Against Register Conflicts**

All reads from and writes to CPU registers occur in either the D2 phase or the E phase of an instruction. A register conflict arises when an instruction attempts to read and/or modify the content of a register (in the D2 phase) before a previous instruction has written to that register (in the E phase).

The pipeline-protection mechanism resolves register conflicts by holding the later instruction in its D2 phase for as many cycles as needed (one to three). You do not have to consider register conflicts unless you wish to achieve maximum pipeline efficiency. If you choose to reduce the number of pipeline-protection cycles, you can identify the pipeline phases in which registers are accessed and try to move conflicting instructions away from each other.

Generally, a register conflict involves one of the address registers:

- 16-bit auxiliary registers AR0–AR7
- 32-bit auxiliary registers XAR0–XAR7
- 16-bit data page pointer (DP)
- 16-bit stack pointer (SP)

Example 4–5 shows a register conflict involving auxiliary register XAR0. The pipeline activity shown is for an *unprotected* pipeline, and for convenience, the F1–D1 phases are not shown. I1 writes to XAR0 at the end of cycle 4. I2 should not attempt to read XAR0 until cycle 5. However, I2 reads XAR0 (to generate an address) during cycle 2. To prevent this conflict, the pipeline-protection mechanism would hold I2 in the D2 phase for three cycles. During these cycles, no new operations occur.

**Example 4–5. Register Conflict**

```
I1:  MOVB  AR0,@7      ; Load AR0 with the value addressed by
                        ; the operand @7 and clear the upper
                        ; half of XAR0.
I2:  MOV  AH,*XAR0    ; Load AH with the value pointed to by
                        ; XAR0.
```

D2	R1	R2	E	W	Cycle
I1					1
I2	I1				2
I2		I1			3
I2			I1		4
I2				I1	5
	I2				6
		I2			7

You can reduce or eliminate pipeline-protection cycles due to a register conflict by inserting other instructions between the instructions that cause the conflict. For example, the code in Example 4–5 could be improved by moving two other instructions from elsewhere in the program (assume that the instructions following SETC SXM operate correctly with PM = 1 and SXM = 1):

```
I1:  MOVB  AR0,@7      ; Load AR0 with the value addressed by
                        ; the operand @7 and clear the upper
                        ; half of XAR0.
      SPM  0           ; PM = 1 (no product shift)
      SETC SXM        ; SXM = 1 (sign extension on)
I2:  MOV  AH,*XAR0    ; Load AH with the value pointed to by
                        ; AR0.
```

Inserting the SPM and SETC instructions reduces the number of pipeline-protection cycles to one. Inserting one more instruction would remove the

need for pipeline protection. As a general rule, if a read operation occurs within three instructions from a write operation to the same register, the pipeline-protection mechanism adds at least one inactive cycle.



## 4.5 Avoiding Unprotected Operations

This section describes pipeline conflicts that the pipeline-protection mechanism does not protect against. These conflicts are avoidable, and this section offers suggestions for avoiding them.

### 4.5.1 Unprotected Program-Space Reads and Writes

The pipeline protects only register and data-space reads and writes. It does not protect the program-space reads done by the PREAD and MAC instructions or the program-space write done by the PWRITE instruction. Be careful with these instructions when using them to access a memory block that is shared by data space and program space.

As an example, suppose a memory location can be accessed at address  $00\ 0D50_{16}$  in program space and address  $0000\ 0D50_{16}$  in data space. Consider the following lines of code:

```
; XAR7 = 000D50 in program space
; Data1 = 000D50 in data space
ADD   @Data1,AH      ; Store AH to data-memory location
                          ; Data1.
PREAD @AR1,*XAR7     ; Load AR1 from program-memory
                          ; location given by XAR7.
```

The operands @Data1 and \*XAR7 are referencing the same location, but the pipeline cannot interpret this fact. The PREAD instruction reads from the memory location (in the R2 phase) before the ADD writes to the memory location (in the W phase).

However, the PREAD is not necessary in this program. Because the location can be accessed by an instruction that reads from data space, you can use another instruction, such as a MOV instruction:

```
ADD   @Data1,AH      ; Store AH to memory location Data1.
MOV   AR1,*XAR7      ; Load AR1 from memory location
                          ; given by XAR7.
```

### 4.5.2 An Access to One Location That Affects Another Location

If an access to one location affects another location, you may need to correct your program to prevent a pipeline conflict. You only need to be concerned about this kind of pipeline conflict if you are addressing a location outside of a protected address range. (See section 4.5.3.). Consider the following example:

```
MOV   @DataA,#4      ; This write to DataA causes a
                          ; peripheral to clear bit 15 of DataB.
$10: TBIT @DataB,#15 ; Test bit 15 of DataB.
      SB   $10,NTC    ; Loop until bit 15 is set.
```

This program causes a misread. The TBIT instruction reads bit 15 (in the R2 phase) before the MOV instruction writes to bit 15 (in the W phase). If the TBIT instruction reads a 1, the code prematurely ends the loop. Because DataA and DataB reference different data-memory locations, the pipeline does not identify this conflict.

However, you can correct this type of error by inserting two or more NOP (no operation) instructions to allow for the delay between the write to DataA and the change to bit 15 of DataB. For example, if a 2-cycle delay is sufficient, you can fix the previous code as follows:

```

MOV  @DataA,#4   ; This write to DataA causes a
                  ; peripheral to clear bit 15 of DataB.
NOP                    ; Delay by 1 cycle.
NOP                    ; Delay by 1 cycle.
$10: TBIT @DataB,#15 ; Test bit 15 of DataB.
SB   $10,NTC      ; Loop until bit 15 is set.

```

### 4.5.3 Write Followed By Read Protection Mode

The CPU contains a write followed by read protection mode to ensure that any read operation that follows a write operation within a protected address range is executed as written by delaying the read operation until the write is initiated.

See your device data sheet for device-specific information about which memory region is write-followed-by-read protected.

The PROTSTART(15:0) and PROTRANGE(15:0) input signals set the protection range. The PROTRANGE(15:0) value is a binary multiple with the smallest block size being 64 words, and the largest being 4M words (64 words, 128 words, 256 words ... 1M words, 2M words, 4M words). The PROTSTART address must always be a multiple of the chosen range. For example, if a 4K block size is selected, then the start address must be a multiple of 4K.

The ENPROT signal enables this feature (when set high), it disables this feature (when set low)

All of the above signals are latched on every cycle. The above signals are connected to registers and can be changed within the application program.

The above mechanism only works for reads that follow writes to the protected area. Reads and write sequences to unprotected areas are not affected, as shown in the following examples.

```
Example 1: write protected_area
           write protected_area
           write protected_area
                                     <- pipe protection
                                           (3 cycles)
           read protected_area

Example 2: write protected_area
           write protected_area
           write protected_area
                                     <- no pipe protection
                                           invoked
           read non_protected_area
                                     <- pipe protection
                                           (2 cycles)
           read protected_area
           read protected_area

Example 3: write non_protected_area
           write non_protected_area
           write non_protected_area
                                     <- no pipe protection
                                           invoked
           read protected_area
```

# C28x Addressing Modes

---

---

---

This chapter describes the addressing modes of the C28x and provides examples.

<b>Topic</b>	<b>Page</b>
5.1 Types of Addressing Modes .....	5-2
5.2 Addressing Modes Select Bit (AMODE) .....	5-4
5.3 Assembler/Compiler Tracking of AMODE Bit .....	5-7
5.4 Direct Addressing Modes (DP) .....	5-8
5.5 Stack Addressing Modes (SP) .....	5-9
5.6 Indirect Addressing Modes .....	5-10
5.7 Register Addressing Modes .....	5-25
5.8 Data/Program/IO space Immediate Addressing Modes .....	5-28
5.9 Program Space Indirect Addressing Modes .....	5-30
5.10 Byte Addressing Modes .....	5-31
5.11 Alignment of 32-Bit Operations .....	5-33

## 5.1 Types of Addressing Modes

The C28x CPU supports four basic types of addressing modes:

Direct Addressing Mode

DP (data page pointer): In this mode, the 16-bit DP register behaves like a fixed page pointer. The instruction supplies a 6-bit or 7-bit offset field, which is concatenated with the value in the DP register. This type of addressing is useful for accessing fixed address data structures, such as peripheral registers and global or static variables in C/C++.

Stack Addressing Mode

SP (stack pointer): In this mode, the 16-bit SP pointer is used to access information on the software stack. The software stack grows from low to high memory on the C28x and the stack pointer always points to the next empty location. The instruction supplies a 6-bit offset field that is subtracted from the current stack pointer value for accessing data on the stack or the stack pointer can be post-incremented or pre-decremented when pushing and popping data from the stack, respectively.

Indirect Addressing Mode

XAR0 to XAR7 (auxiliary register pointers): In this mode, the 32-bit XARn registers behave as generic data pointers. The instruction can direct to post-increment, pre/post-decrement, or index from the current register contents with either a 3-bit immediate offset field or with the contents of another 16-bit register.

Register Addressing Mode

In this mode, another register can be the source or destination operand of an access. This enables register-to-register operations in the C28x architecture.

On most C28x instructions, an 8-bit field in the instruction op-code selects the addressing mode to use and what modification to make to that mode. In the C28x instruction set, this field is referred to as:

loc16

Selects Direct/Stack/Indirect/Register addressing mode for 16-bit data access.

loc32

Selects Direct/Stack/Indirect/Register addressing mode for 32-bit data access.

An example C28x instruction description, which uses the above, would be:

ADD AL,loc16

Take the 16-bit contents of AL register, add the contents of 16-bit location specified by the "loc16" field and store the contents in AL register.

ADDL loc32,ACC

Take the 32-bit contents of the location pointed to by the "loc32" field, add the contents of the 32-bit ACC register, and store the result back into the location specified by the "loc32" field.

Other types of addressing modes supported are:

Data/Program/IO Space Immediate Addressing Modes:

In this mode, the address of the memory operand is embedded in the instruction.

Program Space Indirect Addressing Modes:

Some instructions can access a memory operand located in program space using an indirect pointer. Since memory is unified on the C28x CPU, this enables the reading of two operands in a single cycle.

Only a small number of instructions use the above modes and typically they are in combination with the "loc16/loc32" modes.

The following sections contain detailed descriptions of the addressing modes with example instructions. For more information about the instructions shown in examples throughout this chapter, see *Chapter 6, Assembly Language Instructions*.

## 5.2 Addressing Modes Select Bit (AMODE)

To accommodate various types of addressing modes, an addressing mode bit (AMODE) selects the decoding of the 8-bit field (loc16/loc32). This bit is found in Status Register 1 (ST1). The addressing modes have been broadly classified as follows:

AMODE = 0

This is the default mode on reset and is the mode used by the C28x C/C++ compiler. This mode is not fully compatible to the C2xLP CPU addressing modes. The data page pointer offset is 6-bits (it is 7-bits on the C2xLP) and not all of the indirect addressing modes are supported.

AMODE = 1

This mode contains addressing modes that are fully compatible to the C2xLP device. The data page pointer offset is increased to 7-bits and all of the indirect addressing modes available on the C2xLP are supported.

The available addressing modes, for the "loc16" or "loc32" field, are summarized in Table 5–1.

Table 5–1. Addressing Modes for "loc16" or "loc32"

AMODE = 0		AMODE = 1	
8-Bit Decode	"loc16/loc32" Syntax	8-Bit Decode	"loc16/loc32" Syntax
<b>Direct Addressing Modes (DP) :</b>			
0 0 III III	@6bit	0 I III III	@@7bit
<b>Stack Addressing Modes (SP) :</b>			
0 1 III III	*-SP[6bit]		
1 0 111 101	*SP++	1 0 111 101	*SP++
1 0 111 110	*--SP	1 0 111 110	*--SP
<b>C28x Indirect Addressing Modes (XAR0 to XAR7) :</b>			
1 0 000 AAA	*XARn++	1 0 000 AAA	*XARn++
1 0 001 AAA	*--XARn	1 0 001 AAA	*--XARn
1 0 010 AAA	*+XARn[AR0]	1 0 010 AAA	*+XARn[AR0]
1 0 011 AAA	*+XARn[AR1]	1 0 011 AAA	*+XARn[AR1]
1 1 III AAA	*+XARn[3bit]		

Table 5-1. Addressing Modes for "loc16" or "loc32"

AMODE = 0		AMODE = 1	
8-Bit Decode	"loc16/loc32" Syntax	8-Bit Decode	"loc16/loc32" Syntax
<b>C2xLP Indirect Addressing Modes (ARP, XAR0 to XAR7):</b>			
1 0 111 000	*	1 0 111 000	*
1 0 111 001	***	1 0 111 001	***
1 0 111 010	*--	1 0 111 010	*--
1 0 111 011	*0++	1 0 111 011	*0++
1 0 111 100	*0--	1 0 111 100	*0--
1 0 101 110	*BR0++	1 0 101 110	*BR0++
1 0 101 111	*BR0--	1 0 101 111	*BR0--
1 0 110 RRR	*, ARPn	1 0 110 RRR	*, ARPn
		1 1 000 RRR	***, ARPn
		1 1 001 RRR	*--, ARPn
		1 1 010 RRR	*0++, ARPn
		1 1 011 RRR	*0--, ARPn
		1 1 100 RRR	*BR0++, ARPn
		1 1 101 RRR	*BR0--, ARPn
<b>Circular Indirect Addressing Modes (XAR6, XAR1):</b>			
1 0 111 111	*AR6%++	1 0 111 111	*+XAR6 [AR1%++]
<b>32-Bit Register Addressing Modes (XAR0 to XAR7, ACC, P, XT):</b>			
1 0 100 AAA	@XARn	1 0 100 AAA	@XARn
1 0 101 001	@ACC	1 0 101 001	@ACC
1 0 101 011	@P	1 0 101 011	@P
1 0 101 100	@XT	1 0 101 100	@XT



Table 5–1. Addressing Modes for “loc16” or “loc32”

AMODE = 0		AMODE = 1	
8-Bit Decode	“loc16/loc32” Syntax	8-Bit Decode	“loc16/loc32” Syntax
<b>16-Bit Register Addressing Modes (AR0 to AR7, AH, AL, PH, PL, TH, SP):</b>			
1 0 100 AAA	@ARn	1 0 100 AAA	@ARn
1 0 101 000	@AH	1 0 101 000	@AH
1 0 101 001	@AL	1 0 101 001	@AL
1 0 101 010	@PH	1 0 101 010	@PH
1 0 101 011	@PL	1 0 101 011	@PL
1 0 101 100	@TH	1 0 101 100	@TH
1 0 101 101	@SP	1 0 101 101	@SP

In the “C28x Indirect” addressing modes, the auxiliary register pointer used in the addressing mode is implicitly specified. In the “C2xLP Indirect” addressing modes, a 3-bit pointer called the auxiliary register pointer (ARP) is used to select which of the auxiliary registers is currently used and which pointer is used in the next operation.

The examples below illustrate the differences between the “C28x Indirect” and “C2xLP Indirect” addressing modes:

- ADD AL,\*XAR4++

Read the contents of 16-bit memory location pointed to by register XAR4, add the contents to AL register. Post-increment the contents of XAR4 by 1.

- ADD AL,\*++

Assume ARP pointer in ST1 contains the value 4. Read the contents of 16-bit memory location pointed to by register XAR4, add the contents to AL register. Post-increment the contents of XAR4 by 1.

- ADD AL,\*++,ARP5

Assume ARP pointer in ST1 contains the value 4. Read the contents of 16-bit memory location pointed to by register XAR4, add the contents to AL register. Post-increment the contents of XAR4 by 1. Set the ARP pointer to 5. Now it points to XAR5.

On the C28x instruction syntax, the destination operand is always on the left and the source operands are always on the right.

### 5.3 Assembler/Compiler Tracking of AMODE Bit

The compiler will always assume the addressing mode is set to AMODE = 0 and therefore will only use addressing modes that are valid for AMODE = 0. The assembler can be instructed, via the command line options, to default to either AMODE = 0 or AMODE = 1. The command line options are:

```
-v28           Assumes AMODE = 0 (C28x addressing modes).
-v28 -m20     Assumes AMODE = 1 (full C2xLP compatible addressing
              modes).
```

Additionally, the assembler allows directives to be embedded within a file to instruct the assembler to override the default mode and change syntax checking to the new address mode setting:

```
.c28_amode    Tells assembler that any code that follows assumes AMODE =
              0 (C28x addressing modes).
.lp_amode     Tells assembler that any code that follows assumes AMODE =
              1 (full C2xLP compatible addressing modes)
```

The above directives cannot be nested. The above directives can be used as follows within an assembly program:

```
; File assembled using "-v28" option (assume AMODE = 0):
.           ; This section of code can only use AMODE = 0
           ; addressing modes
.
.
.
.
SETC AMODE  ; Change to AMODE = 1
.lp_amode   ; Tell assembler to check for AMODE = 1 syntax
.           ; This section of code can only use AMODE = 1
           ; addressing modes
.
.
.
.
CLRC AMODE  ; Revert back to AMODE = 0
.c28_amode ; Tell assembler to check for AMODE = 1 syntax
.           ; This section of code can only use AMODE = 0
           ; addressing modes
.
.
.
.
; End of file.
```

## 5.4 Direct Addressing Modes (DP)

AMODE	"loc16/loc32" Syntax	Description
0	@6bit	<p>32bitDataAddr(31:22) = 0</p> <p>32bitDataAddr(21:6) = DP(15:0)</p> <p>32bitDataAddr(5:0) = 6bit</p> <p><b>Note:</b> The 6-bit offset value is concatenated with the 16-bit DP register. The offset value enables 0 to 63 words to be addressed relative to the current DP register value.</p>

Example(s) :

```

MOVW DP,#VarA      ; Load DP pointer with page value containing VarA
ADD AL,@VarA       ; Add memory location VarA to register AL
MOV @VarB,AL       ; Store AL into memory location VarB
                   ; VarB is located in the same 64-word page as VarA
MOVW DP,#VarC      ; Load DP pointer with page value containing VarC
SUB AL,@VarC       ; Subtract memory location VarC from register AL
MOV @VarD,AL       ; Store AL into memory location VarD
                   ; VarC is located in the same 64-word page as VarD
                   ; VarC & D are in different pages than VarA & B
    
```

AMODE	"loc16/loc32" Syntax	Description
1	@@7bit	<p>32bitDataAddr(31:22) = 0</p> <p>32bitDataAddr(21:7) = DP(15:1)</p> <p>32bitDataAddr(6:0) = 7bit</p> <p><b>Note:</b> The 7-bit offset value is concatenated with the upper 15-bits of the DP register. Bit 0 of DP register is ignored and is not affected by the operation. The offset value enables 0 to 127 words to be addressed relative to the current DP register value.</p>

Example(s) :

```

SETC AMODE         ; Make sure AMODE = 1
.lp_ amode         ; Tell assembler that AMODE = 1
MOVW DP,#VarA     ; Load DP pointer with page value containing VarA
ADD AL,@@VarA     ; Add memory location VarA to register AL
MOV @@VarB,AL     ; Store AL into memory location VarB
                   ; VarB is located in the same 128-word page as VarA
MOVW DP,#VarC     ; Load DP pointer with page value containing VarC
SUB AL,@@VarC     ; Subtract memory location VarC from register AL
MOV @@VarD,AL     ; Store AL into memory location VarD
                   ; VarC is located in the same 128-word page as VarD
                   ; VarC & D are in different pages than VarA & B
    
```

**Note:** The direct addressing mode can access only the lower 4M of data address space on the C28x device.

## 5.5 Stack Addressing Modes (SP)

AMODE	"loc16/loc32" Syntax	Description
0	*-SP[6bit]	32bitDataAddr(31:16) = 0x0000 32bitDataAddr(15:0) = SP - 6bit <b>Note:</b> The 6-bit offset value is subtracted from the current 16-bit SP register value. The offset value enables 0 to 63 words to be addressed relative to the current SP register value.

Example(s) :

```

ADD  AL,*-SP[5]      ; Add 16-bit contents from stack location
                        ; -5 words from top of stack to AL register
MOV  *-SP[8],AL      ; Store 16-bit AL register to stack location
                        ; -8 words from top of stack
ADDL ACC,*-SP[12]    ; Add 32-bit contents from stack location
                        ; -12 words from top of stack to ACC register.
MOVL *-SP[34],ACC    ; Store 32-bit ACC register to stack location
                        ; -34 words from top of stack

```

AMODE	"loc16/loc32" Syntax	Description
X	*SP++	32bitDataAddr(31:16) = 0x0000 32bitDataAddr(15:0) = SP if(loc16), SP = SP + 1 if(loc32), SP = SP + 2

Example(s) :

```

MOV  *SP++,AL        ; Push contents of 16-bit AL register onto top
                        ; of stack
MOVL *SP++,P         ; Push contents of 32-bit P register onto top
                        ; of stack

```

AMODE	"loc16/loc32" Syntax	Description
X	*--SP	if(loc16), SP = SP - 1 if(loc32), SP = SP - 2 32bitDataAddr(31:16) = 0x0000 32bitDataAddr(15:0) = SP

Example(s) :

```

ADD  AL,*--SP        ; Pop contents from top of stack and add to 16-bit
                        ; AL register
MOVL ACC,*--SP       ; Pop contents from top of stack and store in
                        ; 32-bit ACC register

```

**Note:** This addressing mode can only access the lower 64K of data address space on the C28x device.

## 5.6 Indirect Addressing Modes

This section includes indirect addressing modes for the 28x and 2xLP devices. It also includes circular indirect addressing modes.

### 5.6.1 C28x Indirect Addressing Modes (XAR0 to XAR7)

AMODE	"loc16/loc32" Syntax	Description
X	*XARn++	ARP = n 32bitDataAddr(31:0) = XARn if(loc16), XARn = XARn + 1 if(loc32), XARn = XARn + 2

Example(s) :

```

    MOVL  XAR2,#Array1      ; Load XAR2 with start address of Array1
    MOVL  XAR3,#Array2     ; Load XAR3 with start address of Array2
    MOV   @AR0,#N-1        ; Load AR0 with loop count N
Loop:
    MOVL  ACC,*XAR2++      ; Load ACC with location pointed to by XAR2,
                          ; post-increment XAR2
    MOVL  *XAR3++,ACC      ; Store ACC into location pointed to by XAR3,
                          ; post-increment XAR3
    BANZ  Loop,AR0--       ; Loop until AR0 == 0, post-decrement AR0
    
```

AMODE	"loc16/loc32" Syntax	Description
X	*--XARn	ARP = n if(loc16), XARn = XARn - 1 if(loc32), XARn = XARn - 2 32bitDataAddr(31:0) = XARn

Example(s) :

```

    MOVL  XAR2,#Array1+N*2 ; Load XAR2 with end address of Array1
    MOVL  XAR3,#Array2+N*2 ; Load XAR3 with end address of Array2
    MOV   @AR0,#N-1        ; Load AR0 with loop count N
Loop:
    MOVL  ACC,*--XAR2      ; Pre-decrement XAR2,
                          ; load ACC with location pointed to by XAR2
    MOVL  *--XAR3,ACC      ; Pre-decrement XAR3,
                          ; store ACC into location pointed to by XAR3,
    BANZ  Loop,AR0--       ; Loop until AR0 == 0, post-decrement AR0
    
```

AMODE	"loc16/loc32" Syntax	Description
X	*+XARn [AR0]	ARP = n 32bitDataAddr(31:0) = XARn + AR0 <b>Note:</b> The lower 16-bits of XAR0 are added to the selected 32-bit register. Upper 16-bits of XAR0 are ignored. AR0 is treated as an unsigned 16-bit value. Overflow into the upper 16-bits of XARn can occur.

Example (s) :

```

MOVW DP,#Array1Ptr ; Point to Array1 Pointer location
MOVL XAR2,@Array1Ptr ; Load XAR2 with pointer to Array1
MOVB XAR0,#16 ; AR0 = 16, AR0H = 0
MOVB XAR1,#68 ; AR1 = 68, AR1H = 0
MOVL ACC,*+XAR2 [AR0] ;; Swap contents of location Array1[16]
MOVL P,*+XAR2 [AR1] ;; with the contents of location Array1[68]
MOVL *+XAR2 [AR1],ACC ;;
MOVL *+XAR2 [AR0],P ;;

```

AMODE	"loc16/loc32" Syntax	Description
X	*+XARn [AR1]	ARP = n 32bitDataAddr(31:0) = XARn + AR1 <b>Note:</b> The lower 16-bits of XAR0 are added to the selected 32-bit register. Upper 16-bits of XAR0 are ignored. AR0 is treated as an unsigned 16-bit value. Overflow into the upper 16-bits of XARn can occur.

Example (s) :

```

MOVW DP,#Array1Ptr ; Point to Array1 Pointer location
MOVL XAR2,@Array1Ptr ; Load XAR2 with pointer to Array1
MOVB XAR0,#16 ; AR0 = 16, AR0H = 0
MOVB XAR1,#68 ; AR1 = 68, AR1H = 0
MOVL ACC,*+XAR2 [AR0] ;; Swap contents of location Array1[16]
MOVL P,*+XAR2 [AR1] ;; with the contents of location Array1[68]
MOVL *+XAR2 [AR1],ACC ;;
MOVL *+XAR2 [AR0],P ;;

```

AMODE	"loc16/loc32" Syntax	Description
X	*+XARn [3bit]	ARP = n 32bitDataAddr(31:0) = XARn + 3bit <b>Note:</b> The immediate value is treated as an unsigned 3-bit value.

Example (s) :

```

MOVW DP,#Array1Ptr ; Point to Array1 Pointer location
MOVL XAR2,@Array1Ptr ; Load XAR2 with pointer to Array1
MOVL ACC,*+XAR2 [2] ;; Swap contents of location Array1[2]
MOVL P,*+XAR2 [5] ;; with the contents of location Array1[5]
MOVL *+XAR2 [5],ACC ;;
MOVL *+XAR2 [2],P ;;

```

**Note:** The assembler also accepts "\*XARn" as an addressing mode. This is the same encoding as the "\*+XARn[0]" mode.

### 5.6.2 C2xLP Indirect Addressing Modes (ARP, XAR0 to XAR7)

A MODE	"loc16/loc32" Syntax	Description
X	*	32bitDataAddr(31:0) = XAR(ARP) <b>Note:</b> The XARn register used is the register pointed to by the current value in the ARP pointer. ARP = 0, points to XAR0, ARP = 1, points to XAR1 and so on.

Example (s) :

```

MOVZ DP, #RegAPtr      ; Load DP with page address containing RegAPtr
MOVZ AR2, @RegAPtr     ; Load AR2 with contents of RegAPtr, AR2H = 0
MOVZ AR3, @RegBPtr     ; Load AR3 with contents of RegBPtr, AR3H = 0
                       ; RegAPtr and RegBPtr are located in the same
                       ; 128 word data page. Both are located in
                       ; the low 64K of data memory space.
NOP * , ARP2           ; Set ARP pointer to point to XAR2
MOV * , #0x0404        ; Store 0x0404 into location pointed by XAR2
NOP * , ARP3           ; Set ARP pointer to point to XAR3
MOV * , #0x8000        ; Store 0x8000 into location pointed by XAR3
    
```

A MODE	"loc16/loc32" Syntax	Description
X	* , ARPn	32bitDataAddr(31:0) = XAR(ARP) ARP = n

Example (s) :

```

MOVZ DP, #RegAPtr      ; Load DP with page address containing RegAPtr
MOVZ AR2, @RegAPtr     ; Load AR2 with contents of RegAPtr, AR2H = 0
MOVZ AR3, @RegBPtr     ; Load AR3 with contents of RegBPtr, AR3H = 0
                       ; RegAPtr and RegBPtr are located in the same
                       ; 128 word data page. Both are located in
                       ; the low 64K of data memory space.
NOP * , ARP2           ; Set ARP pointer to point to XAR2
MOV * , #0x0404, ARP3  ; Store 0x0404 into location pointed by XAR2,
                       ; Set ARP pointer to point to XAR3
MOV * , #0x8000        ; Store 0x8000 into location pointed by XAR3
    
```

AMODE	"loc16/loc32" Syntax	Description
X	***	32bitDataAddr(31:0) = XAR(ARP) if(loc16), XAR(ARP) = XAR(ARP) + 1 if(loc32), XAR(ARP) = XAR(ARP) + 2

Example(s) :

```

MOVL XAR2,#Array1 ; Load XAR2 with start address of Array1
MOVL XAR3,#Array2 ; Load XAR3 with start address of Array2
MOV @AR0,#N-1 ; Load AR0 with loop count N

Loop:
NOP *,ARP2 ; Set ARP pointer to point to XAR2
MOVL ACC,*** ; Load ACC with location pointed to by XAR2,
; post-increment XAR2
NOP *,ARP3 ; Set ARP pointer to point to XAR3
MOVL **+,ACC ; Store ACC into location pointed to by XAR3,
; post-increment XAR3
NOP *,ARP0 ; Set ARP pointer to point to XAR0
XBANZ Loop,*-- ; Loop until AR0 == 0, post-decrement AR0

```

AMODE	"loc16/loc32" Syntax	Description
X	***,ARPn	32bitDataAddr(31:0) = XAR(ARP) if(loc16), XAR(ARP) = XAR(ARP) + 1 if(loc32), XAR(ARP) = XAR(ARP) + 2

Example(s) :

```

MOVL XAR2,#Array1 ; Load XAR2 with start address of Array1
MOVL XAR3,#Array2 ; Load XAR3 with start address of Array2
MOV @AR0,#N-1 ; Load AR0 with loop count N
NOP *,ARP2 ; Set ARP pointer to point to XAR2
SETC AMODE ; Make sure AMODE = 1
.lp_amode ; Tell assembler that AMODE = 1

Loop:
MOVL ACC,***,ARP3 ; Load ACC with location pointed to by XAR2,
; post-increment XAR2, set ARP to point to XAR3
MOVL **+,ACC,ARP0 ; Store ACC into location pointed to by XAR3,
; post-increment XAR3, set ARP to point to XAR0
XBANZ Loop,*--,ARP2 ; Loop until AR0 == 0, post-decrement AR0,
; set ARP pointer to point to XAR2

```



## Indirect Addressing Modes

AMODE	"loc16/loc32" Syntax	Description
X	*--	32bitDataAddr(31:0) = XAR(ARP) if(loc16), XAR(ARP) = XAR(ARP) + 1 if(loc32), XAR(ARP) = XAR(ARP) + 2

Example(s) :

```

MOVL  XAR2,#Array1+(N-1)*2 ; Load XAR2 with end address of Array1
MOVL  XAR3,#Array2+(N-1)*2 ; Load XAR3 with end address of Array2
MOV   @AR0,#N-1           ; Load AR0 with loop count N

```

Loop:

```

NOP   *,ARP2              ; Set ARP pointer to point to XAR2
MOVL  ACC,*--             ; Load ACC with location pointed to by XAR2,
                          ; post-decrement XAR2
NOP   *,ARP3              ; Set ARP pointer to point to XAR3
MOVL  *--,ACC             ; Store ACC into location pointed to by XAR3,
                          ; post-decrement XAR3
NOP   *,ARP0              ; Set ARP pointer to point to XAR0
XBANZ Loop,*--           ; Loop until AR0 == 0, post-decrement AR0

```

AMODE	"loc16/loc32" Syntax	Description
1	*--,ARPn	32bitDataAddr(31:0) = XAR(ARP) if(loc16), XAR(ARP) = XAR(ARP) + 1 if(loc32), XAR(ARP) = XAR(ARP) + 2 ARP = n

```

MOVL  XAR2,#Array1+(N-1)*2 ; Load XAR2 with end address of Array1
MOVL  XAR3,#Array2+(N-1)*2 ; Load XAR3 with end address of Array2
MOV   @AR0,#N-1           ; Load AR0 with loop count N
NOP   *,ARP2              ; Set ARP pointer to point to XAR2
SETC  AMODE                ; Make sure AMODE = 1
.lp_ amode                 ; Tell assembler that AMODE = 1

```

Loop:

```

MOVL  ACC,*--,ARP3        ; Load ACC with location pointed to by XAR2,
                          ; post-increment XAR2, set ARP to point
                          ; to XAR3
MOVL  *--,ACC,ARP0        ; Store ACC into location pointed to by XAR3,
                          ; post-increment XAR3, set ARP to point
                          ; to XAR0
XBANZ  Loop,*--,ARP2      ; Loop until AR0 == 0, post-decrement AR0,
                          ; set ARP pointer to point to XAR2

```

AMODE	"loc16/loc32" Syntax	Description
X	*0++	32bitDataAddr(31:0) = XAR(ARP) $XAR(ARP) = XAR(ARP) + AR0$ <b>Note:</b> The lower 16-bits of XAR0 are added to the selected 32-bit register. Upper 16-bits of XAR0 ignored. AR0 is treated as an unsigned 16-bit value. Overflow into the upper 16-bits of XAR(ARP) can occur.

Example (s) :

```

MOVL XAR2,#Array1 ; Load XAR2 with start address of Array1
MOVL XAR3,#Array2 ; Load XAR3 with start address of Array2
MOV  @AR0,#4      ; Set AR0 to copy every fourth value from
                  ; Array1 to Array2
MOV  @AR1,#N-1    ; Load AR1 with loop count N
Loop:
NOP  *,ARP2       ; Set ARP pointer to point to XAR2
MOVL ACC,*0++    ; Load ACC with location pointed to by XAR2,
                  ; post-increment XAR2 by AR0
NOP  *,ARP3       ; Set ARP pointer to point to XAR3
MOVL **+,ACC     ; Store ACC into location pointed to by XAR3,
                  ; post-increment XAR3
NOP  *,ARP1       ; Set ARP pointer to point to XAR1
XBANZ Loop,*--   ; Loop until AR1 == 0, post-decrement AR1

```

AMODE	"loc16/loc32" Syntax	Description
1	*0++,ARPn	32bitDataAddr(31:0) = XAR(ARP) $XAR(ARP) = XAR(ARP) + AR0$ $ARP = n$ <b>Note:</b> The lower 16-bits of XAR0 are added to the selected 32-bit register. Upper 16-bits of XAR0 ignored. AR0 is treated as an unsigned 16-bit value. Overflow into the upper 16-bits of XAR(ARP) can occur.

Example (s) :

```

MOVL XAR2,#Array1 ; Load XAR2 with start address of Array1
MOVL XAR3,#Array2 ; Load XAR3 with start address of Array2
MOV  @AR0,#4      ; Set AR0 to copy every fourth value from
                  ; Array1 to Array2
MOV  @AR1,#N-1    ; Load AR1 with loop count N
NOP  *,ARP2       ; Set ARP pointer to point to XAR2
SETC AMODE       ; Make sure AMODE = 1
.lp_amos         ; Tell assembler that AMODE = 1
Loop:
MOVL ACC,*0++,ARP3 ; Load ACC with location pointed to by XAR2,
                  ; post-increment XAR2 by AR0, set ARP pointer
                  ; to point to XAR3
MOVL **+,ACC,ARP1 ; Store ACC into location pointed to by XAR3,
                  ; post-increment XAR3, set ARP pointer to point
                  ; to XAR1
XBANZ Loop,*--,ARP2 ; Loop until AR1 == 0, post-decrement AR1,
                  ; set ARP to point to XAR2

```

## Indirect Addressing Modes

AMODE	"loc16/loc32" Syntax	Description
X	*0--	<p>32bitDataAddr(31:0) = XAR(ARP)</p> <p>XAR(ARP) = XAR(ARP) – AR0</p> <p><b>Note:</b> The lower 16-bits of XAR0 are subtracted from the selected 32-bit register. Upper 16-bits of XAR0 ignored. AR0 is treated as an unsigned 16-bit value. Underflow into the upper 16-bits of XAR(ARP) can occur.</p>

Example(s) :

```

MOVL XAR2,#Array1+(N-1)*8 ; Load XAR2 with end address of Array1
MOVL XAR3,#Array2+(N-1)*2 ; Load XAR3 with end address of Array2
MOV  @AR0,#4                ; Set AR0 to copy every fourth value from
                             ; Array1 to Array2
MOV  @AR1,#N-1              ; Load AR1 with loop count N

Loop:
NOP  *,ARP2                  ; Set ARP pointer to point to XAR2
MOVL ACC,*0--                ; Load ACC with location pointed to by
                             ; XAR2, post-decrement XAR2 by AR0
NOP  *,ARP3                  ; Set ARP pointer to point to XAR3
MOVL *--,ACC                 ; Store ACC into location pointed to by
                             ; XAR3, post-decrement XAR3
NOP  *,ARP1                  ; Set ARP pointer to point to XAR1
XBANZ Loop,*--              ; Loop until AR1 == 0, post-decrement AR1

```

AMODE	"loc16/loc32" Syntax	Description
1	*0--,ARPn	<p>32bitDataAddr(31:0) = XAR(ARP)</p> <p>XAR(ARP) = XAR(ARP) – AR0</p> <p>ARP = n</p> <p><b>Note:</b> The lower 16-bits of XAR0 are subtracted from the selected 32-bit register. Upper 16-bits of XAR0 ignored. AR0 is treated as an unsigned 16-bit value. Underflow into the upper 16-bits of XAR(ARP) can occur.</p>

Example(s) :

```

MOVL XAR2,#Array1+(N-1)*8 ; Load XAR2 with end address of Array1
MOVL XAR3,#Array2+(N-1)*2 ; Load XAR3 with end address of Array2
MOV  @AR0,#4                ; Set AR0 to copy every fourth value from
                             ; Array1 to Array2
MOV  @AR1,#N-1              ; Load AR1 with loop count N
NOP  *,ARP2                  ; Set ARP pointer to point to XAR2
SETC AMODE                   ; Make sure AMODE = 1
.lp_amode                    ; Tell assembler that AMODE = 1

Loop:
MOVL ACC,*0--,ARP3          ; Load ACC with location pointed to by
                             ; XAR2, post-decrement XAR2 by AR0, set ARP
                             ; pointer to point to XAR3
MOVL *--,ACC,ARP1           ; Store ACC into location pointed to by
                             ; XAR3, post-decrement XAR3, set ARP
                             ; pointer to point to XAR1
XBANZ Loop,*--,ARP2        ; Loop until AR1 == 0, post-decrement AR1,
                             ; set ARP to point to XAR2

```

AMODE	"loc16/loc32" Syntax	Description
X	*BR0++	32bitDataAddr(31:0) = XAR(ARP) XAR(ARP)(15:0) = AR(ARP) rcadd AR0 XAR(ARP)(31:16) = unchanged <b>Note:</b> The lower 16-bits of XAR0 are reverse carry added (rcadd) to the lower 16-bits of the selected register. Upper 16-bits of XAR0 ignored. Upper 16-bits of the selected register unchanged by the operation.

Example(s) :

```

; Transfer contents of Array1 to Array2 in bit reverse order:
  MOVL  XAR2,#Array1    ; Load XAR2 with start address of Array1
  MOVL  XAR3,#Array2    ; Load XAR3 with start address of Array2
  MOV   @AR0,#N         ; Load AR0 with size of array,
                        ; N must be a multiple of 2 (2,4,8,16,...)
  MOV   @AR1,#N-1      ; Load AR1 with loop count N
Loop:
  NOP   *,ARP2          ; Set ARP pointer to point to XAR2
  MOVL  ACC,***         ; Load ACC with location pointed to by XAR2,
                        ; post-increment XAR2
  NOP   *,ARP3          ; Set ARP pointer to point to XAR3
  MOVL  *BR0++,ACC     ; Store ACC into location pointed to by XAR3,
                        ; post-increment XAR3 with AR0 reverse carry add
  NOP   *,ARP1          ; Set ARP pointer to point to XAR1
  XBANZ Loop,*--       ; Loop until AR1 == 0, post-decrement AR1

```

AMODE	"loc16/loc32" Syntax	Description
1	*BR0++, ARPn	32bitDataAddr(31:0) = XAR(ARP) XAR(ARP)(15:0) = AR(ARP) rcadd AR0 XAR(ARP)(31:16) = unchanged ARP = n <b>Note:</b> The lower 16-bits of XAR0 are reverse carry added (rcadd) to the lower 16-bits of the selected register. Upper 16-bits of XAR0 ignored. Upper 16-bits of the selected register unchanged by the operation.

Example(s) :

```

; Transfer contents of Array1 to Array2 in bit reverse order:
  MOVL  XAR2,#Array1    ; Load XAR2 with start address of Array1
  MOVL  XAR3,#Array2    ; Load XAR3 with start address of Array2
  MOV   @AR0,#N         ; Load AR0 with size of array,
                        ; N must be a multiple of 2 (2,4,8,16,...)
  MOV   @AR1,#N-1      ; Load AR1 with loop count N
  NOP   *,ARP2          ; Set ARP pointer to point to XAR2
  SETC  AMODE           ; Make sure AMODE = 1
  .lp_ amode            ; Tell assembler that AMODE = 1
Loop:
  MOVL  ACC,***,ARP3    ; Load ACC with location pointed to by XAR2,
                        ; post-increment XAR2, set ARP pointer to point
                        ; to XAR3

```

## Indirect Addressing Modes

```

MOVL  *BR0++,ACC,ARP1 ; Store ACC into location pointed to by XAR3,
                        ; post-increment XAR3 with AR0 reverse carry
                        ; add, set ARP pointer to point to XAR1
XBANZ  Loop,*--,ARP2  ; Loop until AR1 == 0, post-decrement AR1,
                        ; set ARP to point to XAR2

```

A MODE	"loc16/loc32" Syntax	Description
X	*BR0--	<p>Address Generation:</p> <p>32bitDataAddr(31:0) = XAR(ARP)</p> <p>XAR(ARP)(15:0) = AR(ARP) rbsub AR0 <b>{see note [1]}</b></p> <p>XAR(ARP)(31:16) = unchanged</p> <p><b>Note:</b> The lower 16-bits of XAR0 are reverse borrow subtracted (rbsub) from the lower 16-bits of the selected register. Upper 16-bits of XAR0 ignored. Upper 16-bits of the selected register unchanged by the operation.</p>

Example(s) :

```

; Transfer contents of Array1 to Array2 in bit reverse order:
MOVL  XAR2,#Array1+(N-1)*2 ; Load XAR2 with end address of Array1
MOVL  XAR3,#Array2+(N-1)*2 ; Load XAR3 with end address of Array2
MOV   @AR0,#N              ; Load AR0 with size of array,
                        ; N must be a multiple of 2 (2,4,8,16,...)
MOV   @AR1,#N-1           ; Load AR1 with loop count N
Loop:
NOP   *,ARP2              ; Set ARP pointer to point to XAR2
MOVL  ACC,*--            ; Load ACC with location pointed to by
                        ; XAR2, post-decrement XAR2
NOP   *,ARP3              ; Set ARP pointer to point to XAR3
MOVL  *BR0--,ACC         ; Store ACC into location pointed to by
                        ; XAR3, post-decrement XAR3 with AR0
                        ; reverse borrow subtract
NOP   *,ARP1              ; Set ARP pointer to point to XAR1
XBANZ Loop,*--           ; Loop until AR1 == 0, post-decrement AR1

```

AMODE	"loc16/loc32" Syntax	Description
1	*BR0--, ARPn	32bitDataAddr(31:0) = XAR(ARP) XAR(ARP)(15:0) = AR(ARP) rbsub AR0 XAR(ARP)(31:16) = unchanged ARP = n <b>Note:</b> The lower 16-bits of XAR0 are reverse borrow subtracted (rbsub) from the lower 16-bits of the selected register. Upper 16-bits of XAR0 ignored. Upper 16-bits of the selected register unchanged by the operation.

Example(s) :

```

; Transfer contents of Array1 to Array2 in bit reverse order:
  MOVL  XAR2, #Array1+(N-1)*2 ; Load XAR2 with end address of Array1
  MOVL  XAR3, #Array2+(N-1)*2 ; Load XAR3 with end address of Array2
  MOV   @AR0, #N                ; Load AR0 with size of array,
                                ; N must be a multiple of 2 (2,4,8,16,...)
  MOV   @AR1, #N-1              ; Load AR1 with loop count N
  NOP   *, ARP2                  ; Set ARP pointer to point to XAR2
  SETC  AMODE                    ; Make sure AMODE = 1
  .lp_ amode                      ; Tell assembler that AMODE = 1
Loop:
  MOVL  ACC, *--, ARP3           ; Load ACC with location pointed to by
                                ; XAR2, post-decrement XAR2, set ARP
                                ; pointer to point to XAR3
  MOVL  *BR0--, ACC, ARP1        ; Store ACC into location pointed to by
                                ; XAR3, post-decrement XAR3 with AR0
                                ; reverse borrow subtract, set ARP pointer
                                ; to point to XAR1
  XBANZ Loop, *--, ARP2          ; Loop until AR1 == 0, post-decrement AR1,
                                ; set ARP pointer to point to XAR2

```

Reverse carry addition or reverse carry subtraction is used to implement bit-reversed addressing as used in the re-ordering of data elements in FFT algorithms. Typically, AR0 is initialized with the (FFT size) /2. The value of AR0 is then added or subtracted, with reverse carry addition or subtraction, to generate the bit reversed address:

Reverse Carry Addition Example Is Shown Below (FFT size = 16):

```

XAR(ARP) (15:0) = 0000 0000 0000 0000
+ AR0           = 0000 0000 0000 1000
-----
XAR(ARP) (15:0) = 0000 0000 0000 1000
+ AR0           = 0000 0000 0000 1000
-----
XAR(ARP) (15:0) = 0000 0000 0000 0100
+ AR0           = 0000 0000 0000 1000
-----
XAR(ARP) (15:0) = 0000 0000 0000 1100
+ AR0           = 0000 0000 0000 1000
-----
XAR(ARP) (15:0) = 0000 0000 0000 0010
+ AR0           = 0000 0000 0000 1000
-----
XAR(ARP) (15:0) = 0000 0000 0000 1010
.....

```

Reverse Borrow Subtraction Example Is Shown Below (FFT size = 16):

```

XAR(ARP) (15:0) = 0000 0000 0000 0000
- AR0           = 0000 0000 0000 1000
-----
XAR(ARP) (15:0) = 0000 0000 0000 1111
- AR0           = 0000 0000 0000 1000
-----
XAR(ARP) (15:0) = 0000 0000 0000 0111
- AR0           = 0000 0000 0000 1000
-----
XAR(ARP) (15:0) = 0000 0000 0000 1011
- AR0           = 0000 0000 0000 1000
-----
XAR(ARP) (15:0) = 0000 0000 0000 0011
- AR0           = 0000 0000 0000 1000
-----
XAR(ARP) (15:0) = 0000 0000 0000 1101
.....

```

On the C28x, the bit reversed addressing is restricted to block size < 64K. This is OK since most FFT implementations are much less than this.

### 5.6.3 Circular Indirect Addressing Modes (XAR6, XAR1)

AMODE	"loc16/loc32" Syntax	Description
0	*AR6%++	<pre> 32bitDataAddr(31:0) = XAR6 if( XAR6(7:0) == XAR1(7:0) ) {   XAR6(7:0) = 0x00   XAR6(15:8) = unchanged } else {   if(16-bit data), XAR6(15:0) =+ 1   if(32-bit data), XAR6(15:0) =+ 2 } XAR6(31:16) = unchanged ARP = 6 </pre>

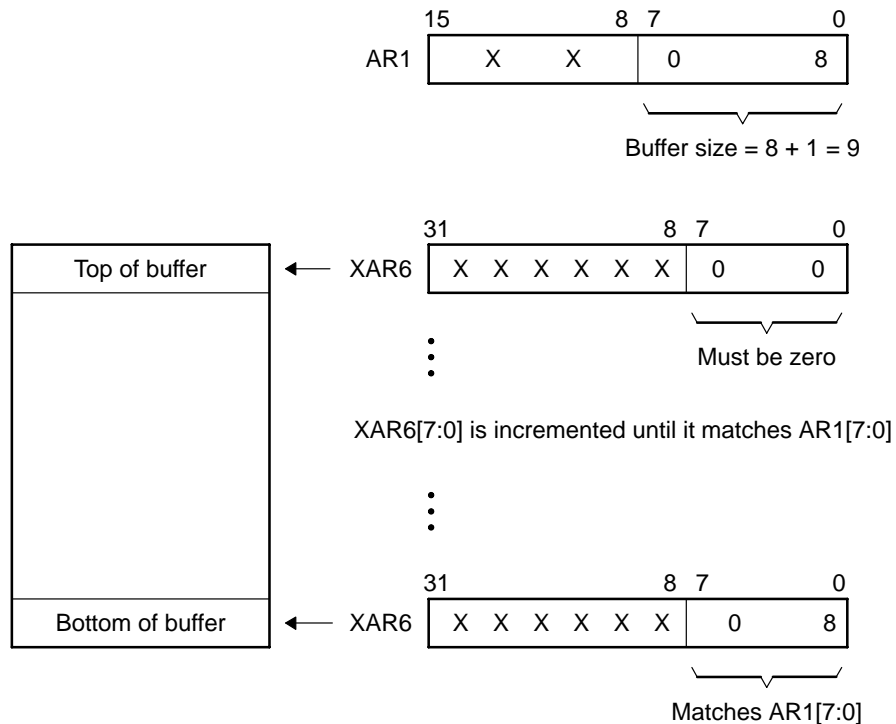
As seen in Figure 5–1, buffer size is determined by the 8 LSBs of AR1 or AR1[7:0]. Specifically, the buffer size is AR1[7:0] + 1. When AR1[7:0] is 255, then the buffer size is at its maximum size of 256 words.

XAR6 points to the current address in the buffer. The top of the buffer must be at an address where the 8 LSBs are all 0s.

If one of the instructions accessing the circular buffer performs a 32-bit operation, make sure XAR6 and AR1 are both even before the buffer is accessed.



Figure 5–1. Circular Buffer with AMODE = 0



Example(s) :

```

; Calculate FIR filter (X[N] = data array, C[N] = coefficient array):
MOVW DP,#Xpointer          ; Load DP with page address of Xpointer
MOVL XAR6,@Xpointer        ; Load XAR6 with current X pointer
MOVL XAR7,#C               ; Load XAR7 with start address of C array
MOV @AR1,#N                ; Load AR1 with size of data array N,
SPM -4                     ; Set product shift mode to ">> 4"
ZAPA                       ; Zero ACC, P, OVC
RPT #N-1                   ; Repeat next instruction N times
| | QMACL P,*AR6%++,*XAR7++ ; ACC = ACC + P >> 4,
                           ; P = (*AR6%++ * *XAR7++) >> 32
ADDL ACC,P << PM           ; Final accumulate
MOVL @Xpointer,XAR6       ; Store XAR6 into current X pointer
MOVL @Sum,ACC              ; Store result into sum
    
```

AMODE	"loc16/loc32" Syntax	Description
1	*+XAR6 [AR1%++]	<p>32bitDataAddr(31:0) = XAR6 + AR1</p> <p>if( XAR1(15:0) == XAR1(31:16) )</p> <pre>{   XAR1(15:0) = 0x0000 }</pre> <p>else</p> <pre>{   if(16-bit data), XAR1(15:0) =+ 1   if(32-bit data), XAR1(15:0) =+ 2 }</pre> <p>XAR1(31:16) = unchanged</p> <p>ARP = 6</p> <p><b>Note:</b> With this addressing mode, there is no circular buffer alignment requirements.</p>

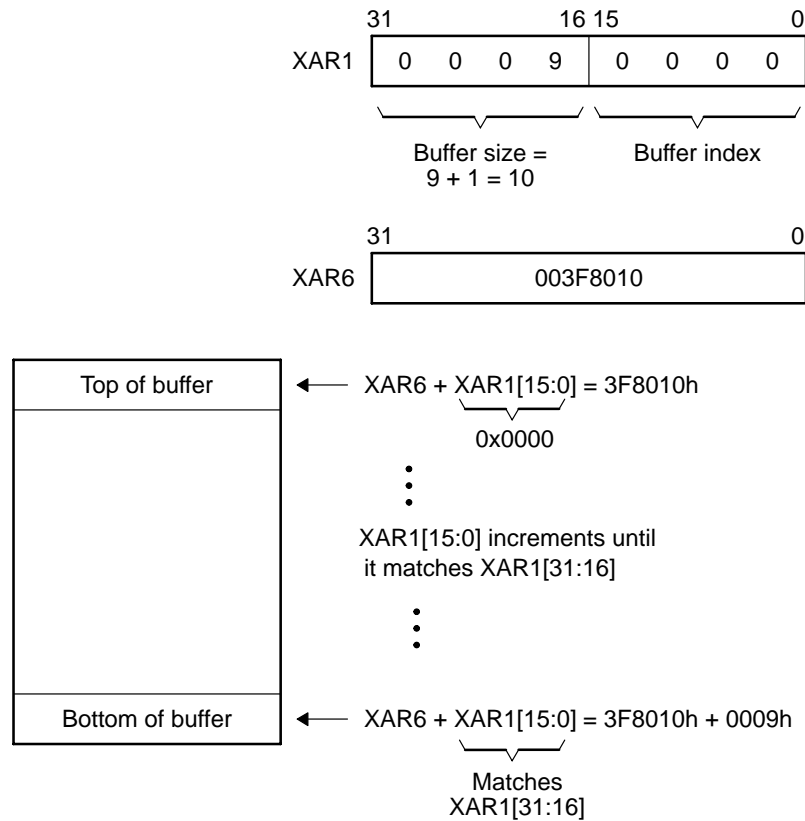
As seen in Figure 5–2, buffer size is determined by the upper 16 bits of XAR1 or XAR1[31:16]. Specifically, the size is XAR1[31:16] + 1.

XAR6 points to the top of the buffer.

The current address in the buffer is pointed to by XAR6 with an offset of XAR1[15:0].

If the instructions that access the circular buffer perform 32-bit operations, make sure XAR6 and XAR1[31:16] are even.

Figure 5–2. Circular Buffer with AMODE = 1



Example(s) :

```

; Calculate FIR filter (X[N] = data array, C[N] = coefficientv array):
MOVW DP,#Xindex          ; Load DP with page address of Xindex
MOVL XAR6,#X             ; Load XAR6 with start address of X array
MOV @AH,#N               ; Load AH with size of array X (N)
MOV AL,@Xindex          ; Load AL with current circular index
MOVL XAR1,@ACC          ; Load parameters into XAR1
MOVL XAR7,#C            ; Load XAR7 with start address of C array
SPM -4                  ; Set product shift mode to ">> 4"
ZAPA                    ; Zero ACC, P, OVC
RPT #N-1                ; Repeat next instruction N times
| QMACL P, *+XAR6 [AR1%++] , *XAR7++ ; ACC = ACC + P >> 4,
; P = (*AR6%++ * *XAR7++) >> 32
ADDL ACC,P << PM        ; Final accumulate
MOV @Xindex,AR1         ; Store AR1 into current X index
MOVL @Sum,ACC           ; Store result into sum
    
```

## 5.7 Register Addressing Modes

This section includes register addressing modes for 32-bit and 16-bit registers.

### 5.7.1 32-Bit Register Addressing Modes

AMODE	"loc32" Syntax	Description
X	@ACC	Access contents of 32-bit ACC register.  When the "@ACC" register is the destination operand, this may affect the Z,N,V,C,OVC flags.

Example (s) :

```

MOVL  XAR6,@ACC      ; Load XAR6 with contents of ACC
MOVL  @ACC,XT        ; Load ACC with contents of XT register
ADDL  ACC,@ACC       ; ACC = ACC + ACC

```

AMODE	"loc32" Syntax	Description
X	@P	Access contents of 32-bit P register.

Example (s) :

```

MOVL  XAR6,@P        ; Load XAR6 with contents of P
MOVL  @P,XT          ; Load P with contents of XT register
ADDL  ACC,@P         ; ACC = ACC + P

```

AMODE	"loc32" Syntax	Description
X	@XT	Access contents of 32-bit XT register.

Example (s) :

```

MOVL  XAR6,@XT       ; Load XAR6 with contents of XT
MOVL  P,@XT          ; Load P with contents of XT register
ADDL  ACC,@XT        ; ACC = ACC + XT

```

AMODE	"loc32" Syntax	Description
X	@XARn	Access contents of 32-bit XARn registers.

Example (s) :

```

MOVL  XAR6,@XAR2     ; Load XAR6 with contents of XAR2
MOVL  P,@XAR2        ; Load P with contents of XAR2 register
ADDL  ACC,@XAR2      ; ACC = ACC + XAR2

```

**Note:** When writing assembly code, the "@" symbol in front of the register is optional. For example: "MOVL ACC,@P" or "MOVL ACC,P". The disassembler will use the @ to indicate operands that are "loc16" or "loc32". For example, MOVL ACC, @P is the MOVL ACC, loc32 instruction and MOVL @ACC, P is the MOVL loc32, P instruction.

### 5.7.2 16-Bit Register Addressing Modes

AMODE	"loc16" Syntax	Description
X	@AL	Access contents of 16-bit AL register. AH register contents are un-affected. When the "@AL" register is the destination operand, this may affect the Z,N,V,C,OVC flags.

Example (s) :

```
MOV PH,@AL      ; Load PH with contents of AL
ADD AH,@AL      ; AH = AH + AL
MOV T,@AL       ; Load T with contents of AL
```

AMODE	"loc16" Syntax	Description
X	@AH	Access contents of 16-bit AH register. AL register contents are un-affected. When the "@AH" register is the destination operand, this may affect the Z,N,V,C,OVC flags.

Example (s) :

```
MOV PH,@AH      ; Load PH with contents of AH
ADD AL,@AH      ; AL = AL + AH
MOV T,@AH       ; Load T with contents of AH
```

AMODE	"loc16" Syntax	Description
X	@PL	Access contents of 16-bit PL register. PH register contents are un-affected.

Example (s) :

```
MOV PH,@PL      ; Load PH with contents of PL
ADD AL,@PL      ; AL = AL + PL
MOV T,@PL       ; Load T with contents of PL
```

AMODE	"loc16" Syntax	Description
X	@PH	Access contents of 16-bit PH register. PL register contents are un-affected.

Example (s) :

```
MOV  PL,@PH      ; Load PL with contents of PH
ADD  AL,@PH      ; AL = AL + PH
MOV  T,@PH       ; Load T with contents of PH
```

AMODE	"loc16" Syntax	Description
X	@TH	Access contents of 16-bit TH register. TL register contents are unaffected.

Example (s) :

```
MOV  PL,@T       ; Load PL with contents of T
ADD  AL,@T       ; AL = AL + T
MOVZ AR4,@T      ; Load AR4 with contents of T, AR4H = 0
```

AMODE	"loc16" Syntax	Description
X	@SP	Access contents of 16-bit SP register.

Example (s) :

```
MOVZ AR4,@SP     ; Load AR4 with contents of SP, AR4H = 0
MOV  AL,@SP      ; Load AL with contents of SP
MOV  @SP,AH      ; Load SP with contents of AH
```

AMODE	"loc16" Syntax	Description
X	@ARn	Access contents of 16-bit AR0 to AR7 registers. AR0H to AR7H register contents are unaffected.

Example (s) :

```
MOVZ AR4,@AR2    ; Load AR4 with contents of AR2, AR4H = 0
MOV  AL,@AR3     ; Load AL with contents of AR3
MOV  @AR5,AH     ; Load AR5 with contents of AH, AR5H = unchanged
```

## 5.8 Data/Program/I/O Space Immediate Addressing Modes

Syntax	Description
<code>*(0:16bit)</code>	<p>32BitDataAddr(31:16) = 0 32BitDataAddr(15:0) = 16-bit immediate value</p> <p><b>Note:</b> If instruction is repeated, the address is post-incremented on each iteration. This addressing mode can only access the low 64K of data space.</p>

Instructions that use this addressing mode:

```
MOV    loc16,*(0:16bit)      ; [loc16] = [0:16bit]
```

```
MOV    *(0:16bit),loc16     ; [loc16] = [0:16bit]
```

Syntax	Description
<code>*(PA)</code>	<p>32BitDataAddr(31:16) = 0 32BitDataAddr(15:0) = PA 16-bit immediate value</p> <p><b>Note:</b> If instruction is repeated, the address is post-incremented on each iteration. The I/O strobe signal is toggled when accessing I/O space with this addressing mode. The data space address lines are used for accessing I/O space.</p>

Instructions that use this addressing mode:

```
OUT    *(PA),loc16          ; IOspace[0:PA] = [loc16]
```

```
UOUT   *(PA),loc16          ; IOspace[0:PA] = [loc16] (unprotected)
```

```
IN     loc16,*(PA)          ; [loc16] = IOspace[0:PA]
```

Syntax	Description
<code>0:pma</code>	<p>22BitProgAddr(21:16) = 0 22BitProgAddr(15:0) = pma 16-bit immediate value</p> <p><b>Note:</b> If instruction is repeated, the address is post-incremented on each iteration. This addressing mode can only access the low 64K of program space.</p>

Instructions that use this addressing mode:

```
MAC    P,loc16,0:pma        ; ACC = ACC + P << PM,  
                                ; P = [loc16] * ProgSpace[0:pma]
```

Syntax	Description
<code>*(pma)</code>	<p>22BitProgAddr(21:16) = 0x3F  22BitProgAddr(15:0) = pma 16-bit immediate value</p> <p><b>Note:</b> If instruction is repeated, the address is post-incremented on each iteration. This addressing mode can only access the upper 64K of program space.</p>

Instructions that use this addressing mode:

```

XPREAD  loc16,*(pma)          ; [loc16] = ProgSpace[0x3F:pma]
XMAC    P,loc16,*(pma)       ; ACC = ACC + P << PM,
                              ; P = [loc16] * ProgSpace[0x3F:pma]
XMACD   P,loc16,*(pma)       ; ACC = ACC + P << PM,
                              ; P = [loc16] * ProgSpace[0x3F:pma],
                              ; [loc16+1] = [loc16]

```



## 5.9 Program Space Indirect Addressing Modes

Syntax	Description
*AL	<p>22BitProgAddr(21:16) = 0x3F                      22BitProgAddr(15:0) = AL</p> <p><b>Note:</b> If instruction is repeated, the address in AL is copied to a shadow register and the value post-incremented on each iteration. The AL register is not modified. This addressing mode can only access the upper 64K of program space.</p>

Instructions that use this addressing mode:

```

XPREAD loc16,*AL          ; [loc16] = ProgSpace[0x3F:AL]
XPWRITE *AL,loc16        ; ProgSpace[0x3F:AL] = [loc16]
```

Syntax	Description
*XAR7	<p>22BitProgAddr(21:0) = XAR7</p> <p><b>Note:</b> If instruction is repeated, only in the XPREAD and XPWRITE instructions, is the address contained in XAR7 copied to a shadow register and the value post-incremented on each iteration. The XAR7 register is not modified. For all other instructions, the address is not incremented even when repeated.</p>

Instructions that use this addressing mode:

```

MAC    P,loc16,*XAR7      ; ACC = ACC + P << PM,
                          ; P = [loc16] * ProgSpace[*XAR7]
DMAC   ACC:P,loc32,*XAR7 ; ACC = ([loc32].MSW * ProgSpace[*XAR7].MSW) >> PM,
                          ; P = ([loc32].LSW * ProgSpace[*XAR7].MSW) >> PM
QMACL  P,loc32,*XAR7      ; ACC = ACC + P >> PM,
                          ; P = ([loc32] * ProgSpace[*XAR7]) >> 32
IMACL  P,loc32,*XAR7      ; ACC = ACC + P,
                          ; P = ([loc32] * ProgSpace[*XAR7]) << PM
PREAD  loc16,*XAR7        ; [loc16] = ProgSpace[*XAR7]
PWRITE *XAR7,loc16        ; ProgSpace[*XAR7] = [loc16]
```

Syntax	Description
*XAR7++	<p>22BitProgAddr(21:0) = XAR7,                      if(16-bit operation) XAR7 = XAR7 + 1,                      if(32-bit operation) XAR7 = XAR7 + 2</p> <p><b>Note:</b> If instruction is repeated, the address is post-incremented as normal.</p>

Instructions that use this addressing mode:

```

MAC    P,loc16,*XAR7++    ; ACC = ACC + P << PM,
                          ; P = [loc16] * ProgSpace[*XAR7++]
DMAC   ACC:P,loc32,*XAR7++ ; ACC=([loc32].MSW * ProgSpace[*XAR7++].MSW)>>PM,
                          ; P=([loc32].LSW * ProgSpace[*XAR7++].MSW)>>PM
QMACL  P,loc32,*XAR7++    ; ACC = ACC + P >> PM,
                          ; P = ([loc32] * ProgSpace[*XAR7++]) >> 32
IMACL  P,loc32,*XAR7++    ; ACC = ACC + P,
                          ; P = ([loc32] * ProgSpace[*XAR7++]) << PM
```

## 5.10 Byte Addressing Modes

Syntax	Description
*+XARn[AR0] *+XARn[AR1] *+XARn[3bit]	<pre> 32BitDataAddr(31:0) = XARn + Offset (Offset = AR0/AR1/3bit) if( Offset == Even Value )     Access LSByte Of 16-bit Memory Location;     Leave MSByte untouched; if( Offset == Odd Value )     Access MSByte Of 16-bit Memory Location;     Leave LSByte untouched; </pre> <p><b>Note:</b> For all other addressing modes, only the LSByte of the addressed location is accessed, the MSByte is left untouched.</p>

## Byte Addressing Modes

---

Instructions that use this addressing mode:

```
MOVb  AX.LSB,loc16 ; if( address mode == *+XARn[AR0/AR1/3bit] )
;   if( offset == even )
;       AX.LSB = [loc16].LSB;
;       AX.MSB = 0x00;
;   if( offset == odd )
;       AX.LSB = [loc16].MSB;
;       AX.MSB = 0x00;
;   else
;       AX.LSB = [loc16].LSB;
;       AX.MSB = 0x00;
MOVb  AX.MSB,loc16 ; if( address mode == *+XARn[AR0/AR1/3bit] )
;   if( offset == even )
;       AX.LSB = untouched;
;       AX.MSB = [loc16].LSB;
;   if( offset == odd )
;       AX.LSB = untouched;
;       AX.MSB = [loc16].MSB;
;   else
;       AX.LSB = untouched;
;       AX.MSB = [loc16].LSB;
MOVb  loc16,AX.LSB ; if( address mode == *+XARn[AR0/AR1/3bit] )
;   if( offset == even )
;       [loc16].LSB = AX.LSB
;       [loc16].MSB = untouched;
;   if( offset == odd )
;       [loc16].LSB = untouched;
;       [loc16].MSB = AX.LSB;
;   else
;       [loc16].LSB = AX.LSB;
;       [loc16].MSB = untouched;
MOVb  loc16,AX.MSB ; if( address mode == *+XARn[AR0/AR1/3bit] )
;   if( offset == even )
;       [loc16].LSB = AX.MSB
;       [loc16].MSB = untouched;
;   if( offset == odd )
;       [loc16].LSB = untouched;
;       [loc16].MSB = AX.MSB;
;   else
;       [loc16].LSB = AX.MSB;
;       [loc16].MSB = untouched;
```

## 5.11 Alignment of 32-Bit Operations

All 32-bit reads and writes to memory are aligned at the memory interface to an even address boundary with the least significant word of the 32-bit data aligned to the even address. The output of the address generation unit does not force alignment, hence pointer values retain their values. For example:

```
MOVB  AR0,#5 ; AR0 = 5
MOVL  *AR0,ACC ; AL -> address 0x000004
      ; AH -> address 0x000005
      ; AR0 = 5
```

The programmer must take the above into account when generating addresses that are not aligned to an even boundary.

32-bit operands are stored in the following order; low order bits, 0 to 15, followed by the high order bits, 16 to 31, on the next highest 16-bit address increment (little-endian format).



# C28x Assembly Language Instructions

---

---

---

This chapter presents summaries of the instruction set, defines special symbols and notations used, and describes each instruction in detail in alphabetical order.

<b>Topic</b>	<b>Page</b>
<b>6.1 Instruction Set Summary (Organized by Function) .....</b>	<b>6-2</b>
<b>6.2 Register Operations .....</b>	<b>6-4</b>

## 6.1 Instruction Set Summary (Organized by Function)

**Note:** The examples in this chapter assume that the device is already operating in C28x Mode (OBJMODE == 1, AMODE == 0). To put the device into C28x mode following a reset, you must first set the OBJMODE bit in ST1 by executing the “C28OBJ” (or “SETC OBJMODE”) instruction.

**Note:** Cycle Counts assume the instruction is executed from zero-wait (single-cycle) memory and there are no pipeline stalls.

Table 6–1. Instruction Set Summary (Organized by Function)

Symbol	Description
XARn	XAR0 to XAR7 registers
ARn, ARm	Lower 16-bits of XAR0 to XAR7 registers
ARnH	Upper 16-bits of XAR0 to XAR7 registers
ARPn	3-bit auxiliary register pointer, ARP0 to ARP7 ARP0 points to XAR0 and ARP7 points to XAR7
AR(ARP)	Lower 16-bits of auxiliary register pointed to by ARP
XAR(ARP)	Auxiliary registers pointed to by ARP
AX	Accumulator high (AH) and low (AL) registers
#	Immediate operand
PM	Product shift mode (+4,1,0,-1,-2,-3,-4,-5,-6)
PC	Program counter
~	Bitwise compliment
[loc16]	Contents of 16-bit location
0:[loc16]	Contents of 16-bit location, zero extended
S:[loc16]	Contents of 16-bit location, sign extended
[loc32]	Contents of 32-bit location
0:[loc32]	Contents of 32-bit location, zero extended
S:[loc32]	Contents of 32-bit location, sign extended
7bit	7-bit immediate value
0:7bit	7-bit immediate value, zero extended
S:7bit	7-bit immediate value, sign extended

*Table 6–1. Instruction Set Summary (Organized by Function) (Continued)*

<b>Symbol</b>	<b>Description</b>
8bit	8-bit immediate value
0:8bit	8-bit immediate value, zero extended
S:8bit	8-bit immediate value, sign extended
10bit	10-bit immediate value
0:10bit	10-bit immediate value, zero extended
16bit	16-bit immediate value
0:16bit	16-bit immediate value, zero extended
S:16bit	16-bit immediate value, sign extended
22bit	22-bit immediate value
0:22bit	22-bit immediate value, zero extended
LSb	Least Significant bit
LSB	Least Significant Byte
LSW	Least Significant Word
MSb	Most Significant bit
MSB	Most Significant Byte
MSW	Most Significant Word
OBJ	OBJMODE bit state for which instruction is valid
N	Repeat count (N = 0,1,2,3,4,5,6,7,....)
{ }	Optional field
=	Assignment
==	Equivalent to



## 6.2 Register Operations

**Note:** The examples in this chapter assume that the device is already operating in C28x Mode (OBJMODE == 1, AMODE == 0). To put the device into C28x mode following a reset, you must first set the OBJMODE bit in ST1 by executing the “C28OBJ” (or “SETC OBJMODE”) instruction.

**Note:** Cycle Counts assume the instruction is executed from zero-wait (single-cycle) memory and there are no pipeline stalls.

Table 6–2. Register Operations

Mnemonic		Description	Page
<b>XARn Register Operations (XAR0–XAR7)</b>			
ADDB	XARn,#7bit	Add 7-bit constant to auxiliary register	6-33
ADRK	#8bit	Add 8-bit constant to current auxiliary register	6-42
CMPR	0/1/2/3	Compare auxiliary registers	6-82
MOV	AR6/7,loc16	Load auxiliary register	6-160
MOV	loc16,ARn	Store 16-bit auxiliary register	6-168
MOV	XARn,PC	Save the current program counter	6-182
MOVB	AR6/7,#8bit	Load auxiliary register with an 8-bit constant	6-188
MOVB	XARn,#8bit	Load auxiliary register with 8-bit value	6-200
MOVL	loc32,XARn	Store 32-bit auxiliary register	6-210
MOVL	XARn,loc32	Load 32-bit auxiliary register	6-214
MOVL	XARn,#22bit	Load 32-bit auxiliary register with constant value	6-215
MOVZ	ARn,loc16	Load lower half of XARn and clear upper half	6-225
SBRK	#8bit	Subtract 8-bit constant from current auxiliary register	6-319
SUBB	XARn,#7bit	Subtract 7-bit constant from auxiliary register	6-342
<b>DP Register Operations</b>			
MOV	DP,#10bit	Load data-page pointer	6-162
MOVW	DP,#16bit	Load the entire data page	6-223
MOVZ	DP,#10bit	Load data page and clear high bits	6-226
<b>SP Register Operations</b>			
ADDB	SP,#7bit	Add 7-bit constant to stack pointer	6-32
POP	ACC	Pop ACC register from stack	6-267

Table 6–2. Register Operations (Continued)

<b>Mnemonic</b>		<b>Description</b>	<b>Page</b>
POP	AR1:AR0	Pop AR1 & AR0 registers from stack	6-268
POP	AR1H:AR0H	Pop AR1H & AR0H registers from stack	6-269
<b>SP Register Operations (Continued)</b>			
POP	AR3:AR2	Pop AR3 & AR2 registers from stack	6-268
POP	AR5:AR4	Pop AR5 & AR4 registers from stack	6-268
POP	DBGIER	Pop DBGIER register from stack	6-270
POP	DP:ST1	Pop DP & ST1 registers on stack	6-272
POP	DP	Pop DP register from stack	6-271
POP	IFR	Pop IFR register from stack	6-273
POP	loc16	Pop "loc16" data from stack	6-274
POP	P	Pop P register from stack	6-275
POP	RPC	Pop RPC register from stack	6-276
POP	ST0	Pop ST0 register from stack	6-277
POP	ST1	Pop ST1 register from stack	6-278
POP	T:ST0	Pop T & ST0 registers from stack	6-279
POP	XT	Pop XT register from stack	6-281
POP	XARn	Pop auxiliary register from stack	6-280
PUSH	ACC	Push ACC register on stack	6-284
PUSH	ARn:ARn	Push ARn & ARn registers on stack	6-285
PUSH	AR1H:AR0H	Push AR1H & AR0H registers on stack	6-286
PUSH	DBGIER	Push DBGIER register on stack	6-287
PUSH	DP:ST1	Push DP & ST1 registers on stack	6-289
PUSH	DP	Push DP register on stack	6-288
PUSH	IFR	Push IFR register on stack	6-290
PUSH	loc16	Push "loc16" data on stack	6-291
PUSH	P	Push P register on stack	6-292
PUSH	RPC	Push RPC register on stack	6-293

Table 6–2. Register Operations (Continued)

<b>Mnemonic</b>		<b>Description</b>	<b>Page</b>
PUSH	ST0	Push ST0 register on stack	6-294
PUSH	ST1	Push ST1 register on stack	6-295
<b>SP Register Operations (Continued)</b>			
PUSH	T:ST0	Push T & ST0 registers on stack	6-296
PUSH	XT	Push XT register on stack	6-298
PUSH	XARn	Push auxiliary register on stack	6-297
SUBB	SP,#7bit	Subtract 7-bit constant from the stack pointer	6-341
<b>AX Register Operations (AH, AL)</b>			
ADD	AX,loc16	Add value to AX	6-27
ADD	loc16,AX	Add AX to specified location	6-28
ADDB	AX,#8bit	Add 8-bit constant to AX	6-31
AND	AX,loc16,#16bit	Bitwise AND	6-45
AND	AX,loc16	Bitwise AND	6-49
AND	loc16,AX	Bitwise AND	6-48
ANDB	AX,#8bit	Bitwise AND 8-bit value	6-51
ASR	AX,1..16	Arithmetic shift right	6-53
ASR	AX,T	Arithmetic shift right by T(3:0) = 0...15	6-54
CMP	AX,loc16	Compare	6-74
CMPB	AX,#8bit	Compare 8-bit value	6-79
FLIP	AX	Flip order of bits in AX register	6-96
LSL	AX,1..16	Logical shift left	6-135
LSL	AX,T	Logical shift left by T(3:0) = 0...15	6-136
LSR	AX,1..16	Logical shift right	6-140
LSR	AX,T	Logical shift right by T(3:0) = 0..15	6-136
MAX	AX,loc16	Find the maximum	6-149
MIN	AX,loc16	Find the minimum	6-153
MOV	AX,loc16	Load AX	6-161

Table 6–2. Register Operations (Continued)

<b>Mnemonic</b>		<b>Description</b>	<b>Page</b>
MOV	loc16,AX	Store AX	6-169
MOV	loc16,AX,COND	Store AX register conditionally	6-170
<b>AX Register Operations (AH, AL) (Continued)</b>			
MOVB	AX,#8bit	Load AX with 8-bit constant	6-189
MOVB	AX.LSB,loc16	Load LSB of AX reg, MSB = 0x00	6-190
MOVB	AX.MSB,loc16	Load MSB of AX reg, LSB = unchanged	6-192
MOVB	loc16,AX.LSB	Store LSB of AX reg	6-196
MOVB	loc16,AX.MSB	Store MSB of AX reg	6-198
NEG	AX	Negate AX register	6-245
NOT	AX	Complement AX register	6-256
OR	AX,loc16	Bitwise OR	6-259
OR	loc16,AX	Bitwise OR	6-263
ORB	AX,#8bit	Bitwise OR 8-bit value	6-264
SUB	AX,loc16	Subtract specified location from AX	6-338
SUB	loc16,AX	Subtract AX from specified location	6-339
SUBR	loc16,AX	Reverse-subtract specified location from AX	6-354
SXTB	AX	Sign extend LSB of AX reg into MSB	
XOR	AX,loc16	Bitwise exclusive OR	6-384
XORB	AX,#8bit	Bitwise exclusive OR 8-bit value	6-387
XOR	loc16,AX	Bitwise exclusive OR	6-385
<b>16-Bit ACC Register Operations</b>			
ADD	ACC,loc16 {<< 0..16}	Add value to accumulator	6-25
ADD	ACC,#16bit {<< 0..15}	Add value to accumulator	6-22
ADD	ACC,loc16 << T	Add shifted value to accumulator	6-24
ADDB	ACC,#8bit	Add 8-bit constant to accumulator	6-30
ADDCU	ACC,loc16	Add unsigned value plus carry to accumulator	6-35
ADDU	ACC,loc16	Add unsigned value to accumulator	6-39

Table 6–2. Register Operations (Continued)

Mnemonic		Description	Page
AND	ACC,loc16	Bitwise AND	6-44
AND	ACC,#16bit {<< 0..16}	Bitwise AND	6-43
<b>16-Bit ACC Register Operations (Continued)</b>			
MOV	ACC,loc16 {<< 0..16}	Load accumulator with shift	6-159
MOV	ACC,#16bit {<< 0..15}	Load accumulator with shift	6-159
MOV	loc16,ACC << 1..8	Save low word of shifted accumulator	6-167
MOV	ACC,loc16 << T	Load accumulator with shift	6-158
MOVB	ACC,#8bit	Load accumulator with 8-bit value	6-187
MOVH	loc16,ACC << 1..8	Save high word of shifted accumulator	6-202
MOVU	ACC,loc16	Load accumulator with unsigned word	6-220
SUB	ACC,loc16 << T	Subtract shifted value from accumulator	6-335
SUB	ACC,loc16 {<< 0..16}	Subtract shifted value from accumulator	6-333
SUB	ACC,#16bit {<< 0..15}	Subtract shifted value from accumulator	6-337
SUBB	ACC,#8bit	Subtract 8-bit value	6-340
SBBU	ACC,loc16	Subtract unsigned value plus inverse borrow	6-317
SUBU	ACC,loc16	Subtract unsigned 16-bit value	6-356
OR	ACC,loc16	Bitwise OR	6-257
OR	ACC,#16bit {<< 0..16}	Bitwise OR	6-258
XOR	ACC,loc16	Bitwise exclusive OR	6-382
XOR	ACC,#16bit {<< 0..16}	Bitwise exclusive OR	6-383
ZALR	ACC,loc16	Zero AL and load AH with rounding	6-394
<b>32-Bit ACC Register Operations</b>			
ABS	ACC	Absolute value of accumulator	6-19
ABSTC	ACC	Absolute value of accumulator and load TC	6-20
ADDL	ACC,loc32	Add 32-bit value to accumulator	6-36
ADDL	loc32,ACC	Add accumulator to specified location	6-38
ADDCL	ACC,loc32	Add 32-bit value plus carry to accumulator	6-34

Table 6–2. Register Operations (Continued)

<b>Mnemonic</b>		<b>Description</b>	<b>Page</b>
ADDUL	ACC,loc32	Add 32-bit unsigned value to accumulator	6-41
ADDL	ACC,P << PM	Add shifted P to accumulator	6-37
<b>32-Bit ACC Register Operations (Continued)</b>			
ASRL	ACC,T	Arithmetic shift right of accumulator by T(4:0)	6-57
CMPL	ACC,loc32	Compare 32-bit value	6-80
CMPL	ACC,P << PM	Compare 32-bit value	6-81
CSB	ACC	Count sign bits	6-83
LSL	ACC,1..16	Logical shift left 1 to 16 places	6-133
LSL	ACC,T	Logical shift left by T(3:0) = 0...15	6-134
LSRL	ACC,T	Logical shift right by T(4:0)	6-144
LSLL	ACC,T	Logical shift left by T(4:0)	6-139
MAXL	ACC,loc32	Find the 32-bit maximum	6-152
MINL	ACC,loc32	Find the 32-bit minimum	6-155
MOVL	ACC,loc32	Load accumulator with 32 bits	6-204
MOVL	loc32,ACC	Store 32-bit accumulator	6-206
MOVL	P,ACC	Load P from the accumulator	6-212
MOVL	ACC,P << PM	Load the accumulator with shifted P	6-205
MOVL	loc32,ACC,COND	Store ACC conditionally	6-207
NORM	ACC,XARn+/-	Normalize ACC and modify selected auxiliary register.	6-253
NORM	ACC,*ind	C2XLP compatible Normalize ACC operation	6-251
NEG	ACC	Negate ACC	6-244
NEGTC	ACC	If TC is equivalent to 1, negate ACC	6-248
NOT	ACC	Complement ACC	6-255
ROL	ACC	Rotate ACC left	6-310
ROR	ACC	Rotate ACC right	6-311
SAT	ACC	Saturate ACC based on OVC value	6-313
SFR	ACC,1..16	Shift accumulator right by 1 to 16 places	6-325

Table 6–2. Register Operations (Continued)

Mnemonic		Description	Page
SFR	ACC,T	Shift accumulator right by T(3:0) = 0...15	6-326
SUBBL	ACC,loc32	Subtract 32-bit value plus inverse borrow	6-343
<b>32-Bit ACC Register Operations (Continued)</b>			
SUBCU	ACC,loc16	Subtract conditional 16-bit value	6-345
SUBCUL	ACC,loc32	Subtract conditional 32-bit value	6-347
SUBL	ACC,loc32	Subtract 32-bit value	6-350
SUBL	loc32,ACC	Subtract 32-bit value	6-353
SUBL	ACC,P << PM	Subtract 32-bit value	6-351
SUBRL	loc32,ACC	Reverse-subtract specified location from ACC	6-355
SUBUL	ACC,loc32	Subtract unsigned 32-bit value	6-357
TEST	ACC	Test for accumulator equal to zero	6-362
<b>64-Bit ACC:P Register Operations</b>			
ASR64	ACC:P,#1..16	Arithmetic shift right of 64-bit value	6-55
ASR64	ACC:P,T	Arithmetic shift right of 64-bit value by T(5:0)	6-56
CMP64	ACC:P	Compare 64-bit value	6-77
LSL64	ACC:P,1..16	Logical shift left 1 to 16 places	6-137
LSL64	ACC:P,T	64-bit logical shift left by T(5:0)	6-138
LSR64	ACC:P,#1..16	64-bit logical shift right by 1 to 16 places	6-142
LSR64	ACC:P,T	64-bit logical shift right by T(5:0)	6-143
NEG64	ACC:P	Negate ACC:P	6-246
SAT64	ACC:P	Saturate ACC:P based on OVC value	6-314
<b>P or XT Register Operations (P, PH, PL, XT, T, TL)</b>			
ADDUL	P,loc32	Add 32-bit unsigned value to P	6-40
MAXCUL	P,loc32	Conditionally find the unsigned maximum	6-150
MINCUL	P,loc32	Conditionally find the unsigned minimum	6-154
MOV	PH,loc16	Load the high half of the P register	6-177
MOV	PL,loc16	Load the low half of the P register	6-178

Table 6–2. Register Operations (Continued)

<b>Mnemonic</b>		<b>Description</b>	<b>Page</b>
MOV	loc16,P	Store lower half of shifted P register	6-174
MOV	T,loc16	Load the upper half of the XT register	6-180
<b>P or XT Register Operations (P, PH, PL, XT, T, TL) (Continued)</b>			
MOV	loc16,T	Store the T register	6-175
MOV	TL,#0	Clear the lower half of the XT register	6-181
MOVA	T,loc16	Load the T register and add the previous product	6-183
MOVAD	T,loc16	Load T register	6-185
MOVDL	XT,loc32	Store XT and load new XT	6-201
MOVH	loc16,P	Save the high word of the P register	6-203
MOVL	P,loc32	Load the P register	6-213
MOVL	loc32,P	Store the P register	6-209
MOVL	XT,loc32	Load the XT register	6-216
MOVL	loc32,XT	Store the XT register	6-211
MOVDP	T,loc16	Load the T register and store P in the accumulator	6-217
MOVSP	T,loc16	Load T and subtract P from the accumulator	6-218
MOVX	TL,loc16	Load lower half of XT with sign extension	6-224
SUBUL	P,loc32	Subtract unsigned 32-bit value	6-358
<b>16x16 Multiply Operations</b>			
DMAC	ACC:P,loc32,*XAR7/++	16-bit dual multiply and accumulate	6-86
MAC	P,loc16,0:pma	Multiply and accumulate	6-145
MAC	P,loc16,*XAR7/++	Multiply and Accumulate	6-147
MPY	P,T,loc16	16 X 16 multiply	6-230
MPY	P,loc16,#16bit	16 X 16-bit multiply	6-229
MPY	ACC,T,loc16	16 X 16-bit multiply	6-228
MPY	ACC,loc16,#16bit	16 X 16-bit multiply	6-227
MPYA	P,loc16,#16bit	16 X 16-bit multiply and add previous product	6-231
MPYA	P,T,loc16	16 X 16-bit multiply and add previous product	6-233



Table 6–2. Register Operations (Continued)

Mnemonic		Description	Page
MPYB	P,T,#8bit	Multiply signed value by unsigned 8-bit constant	6-236
MPYS	P,T,loc16	16 X 16-bit multiply and subtract	6-237
<b>16x16 Multiply Operations (Continued)</b>			
MPYB	ACC,T,#8bit	Multiply by 8-bit constant	6-235
MPYU	ACC,T,loc16	16 X 16-bit unsigned multiply	6-240
MPYU	P,T,loc16	Unsigned 16 X 16 multiply	6-239
MPYXU	P,T,loc16	Multiply signed value by unsigned value	6-242
MPYXU	ACC,T,loc16	Multiply signed value by unsigned value	6-241
SQRA	loc16	Square value and add P to accumulator	6-329
SQRS	loc16	Square value and subtract from accumulator	6-331
XMAC	P,loc16,*(pma)	C2xLP source-compatible multiply and accumulate	6-378
XMACD	P,loc16,*(pma)	C2xLP source-compatible multiply and accumulate with data move	6-380
<b>32x32 Multiply Operations</b>			
IMACL	P,loc32,*XAR7/++	Signed 32 X 32-bit multiply and accumulate (lower half)	6-100
IMPYAL	P,XT,loc32	Signed 32-bit multiply (lower half) and add previous P	6-103
IMPYL	P,XT,loc32	Signed 32 X 32-bit multiply (lower half)	6-106
IMPYL	ACC,XT,loc32	Signed 32 X 32-bit multiply (lower half)	6-105
IMPYSL	P,XT,loc32	Signed 32-bit multiply (lower half) and subtract P	6-107
IMPYXUL	P,XT,loc32	Signed 32 X unsigned 32-bit multiply (lower half)	6-109
QMACL	P,loc32,*XAR7/++	Signed 32 X 32-bit multiply and accumulate (upper half)	6-300
QMPYAL	P,XT,loc32	Signed 32-bit multiply (upper half) and add previous P	6-302
QMPYL	ACC,XT,loc32	Signed 32 X 32-bit multiply (upper half)	6-305
QMPYL	P,XT,loc32	Signed 32 X 32-bit multiply (upper half)	6-304
QMPYSL	P,XT,loc32	Signed 32-bit multiply (upper half) and subtract previous P	6-306
QMPYUL	P,XT,loc32	Unsigned 32 X 32-bit multiply (upper half)	6-308
QMPYXUL	P,XT,loc32	Signed 32 X unsigned 32-bit multiply (upper half)	6-309

Table 6–2. Register Operations (Continued)

Mnemonic		Description	Page
<b>Direct Memory Operations</b>			
ADD	loc16,#16bitSigned	Add constant to specified location	6-29
<b>Direct Memory Operations (Continued)</b>			
AND	loc16,#16bitSigned	Bitwise AND	6-50
CMP	loc16,#16bitSigned	Compare	6-75
DEC	loc16	Decrement by 1	6-84
DMOV	loc16	Data move contents of 16-bit location	6-89
INC	loc16	Increment by 1	6-113
MOV	*(0:16bit),loc16	Move value	6-156
MOV	loc16,*(0:16bit)	Move value	6-165
MOV	loc16,#16bit	Save 16-bit constant	6-164
MOV	loc16,#0	Clear 16-bit location	6-166
MOVB	loc16,#8bit,COND	Store byte conditionally	6-194
OR	loc16,#16bit	Bitwise OR	6-262
TBIT	loc16,#bit	Test bit	6-359
TBIT	loc16,T	Test bit specified by T register	6-360
TCLR	loc16,#bit	Test and clear specified bit	6-361
TSET	loc16,#bit	Test and set specified bit	6-365
XOR	loc16,#16bit	Bitwise exclusive OR	6-386
<b>IO Space Operations</b>			
IN	loc16,*(PA)	Input data from port	6-111
OUT	*(PA),loc16	Output data to port	6-265
UOUT	*(PA),loc16	Unprotected output data to I/O port	6-366
<b>Program Space Operations</b>			
PREAD	loc16,*XAR7	Read from program memory	6-282
PWRITE	*XAR7,loc16	Write to program memory	6-299
XPREAD	loc16,*AL	C2xLP source-compatible program read	6-389

Table 6–2. Register Operations (Continued)

Mnemonic		Description	Page
XPREAD	loc16,*(pma)	C2xLP source-compatible program read	6-388
XPWRITE	*AL,loc16	C2xLP source-compatible program write	6-390
<b>Branch/Call/Return Operations</b>			
B	16bitOff,COND	Conditional branch	6-58
BANZ	16bitOff,ARn---	Branch if auxiliary register not equal to zero	6-59
BAR	16bitOff,ARn,ARn,EQ/NEQ	Branch on auxiliary register comparison	6-60
BF	16bitOff,COND	Branch fast	6-61
FFC	XAR7,22bitAddr	Fast function call	6-95
IRET		Interrupt return	6-116
LB	22bitAddr	Long branch	6-120
LB	*XAR7	Long indirect branch	6-119
LC	22bitAddr	Long call immediate	6-122
LC	*XAR7	Long indirect call	6-121
LCR	22bitAddr	Long call using RPC	6-123
LCR	*XARn	Long indirect call using RPC	6-124
LOOPZ	loc16,#16bit	Loop while zero	6-127
LOOPNZ	loc16,#16bit	Loop while not zero	6-125
LRET		Long return	6-130
LRETE		Long return and enable interrupts	6-131
LRETR		Long return using RPC	6-132
RPT	#8bit/loc16	Repeat next instruction	6-312
SB	8bitOff,COND	Short conditional branch	6-316
SBF	8bitOff,EQ/NEQ/TC/NTC	Short fast conditional branch	6-318
XB	pma	C2XLP source-compatible branch	6-369
XB	pma,COND	C2XLP source-compatible conditional branch	6-370
XB	pma,*,ARPn	C2XLP source-compatible branch function call	6-369
XB	*AL	C2XLP source-compatible function call	6-368

Table 6–2. Register Operations (Continued)

<b>Mnemonic</b>		<b>Description</b>	<b>Page</b>
XBANZ	pma,*ind{,ARPN}	C2XLP source-compatible branch if ARn is not zero	6-372
XCALL	pma	C2XLP source-compatible call	6-375
<b>Branch/Call/Return Operations (Continued)</b>			
XCALL	pma,COND	C2XLP source-compatible conditional call	6-376
XCALL	pma,*ARPN	C2XLP source-compatible call with ARP modification	6-375
XCALL	*AL	C2XLP source-compatible indirect call	6-374
XRET		Alias for XRETC UNC	6-391
XRETC	COND	C2XLP source-compatible conditional return	6-392
<b>Interrupt Register Operations</b>			
AND	IER,#16bit	Bitwise AND to disable specified CPU interrupts	6-46
AND	IFR,#16bit	Bitwise AND to clear pending CPU interrupts	6-47
IACK	#16bit	Interrupt acknowledge	6-97
INTR	INT1../INT14 NMI EMUINT DLOGINT RTOSINT	Emulate hardware interrupts	6-114
MOV	IER,loc16	Load the interrupt-enable register	6-163
MOV	loc16,IER	Store interrupt enable register	6-172
OR	IER,#16bit	Bitwise OR	6-260
OR	IFR,#16bit	Bitwise OR	6-261
TRAP	#0..31	Software trap	6-363
<b>Status Register Operations (ST0, ST1)</b>			
CLRC	Mode	Clear status bits	6-72
CLRC	XF	Clear the XF status bit and output signal	6-71
CLRC	AMODE	Clear the AMODE bit	6-67
C28ADDR		Clear the AMODE status bit	6-64
CLRC	OBJMODE	Clear the OBJMODE bit	6-69
C27OBJ		Clear the OBJMODE bit	6-63

Table 6–2. Register Operations (Continued)

Mnemonic		Description	Page
CLRC	M0M1MAP	Clear the M0M1MAP bit	6-68
C27MAP		Set the M0M1MAP bit	6-62
<b>Status Register Operations (ST0, ST1) (Continued)</b>			
CLRC	OVC	Clear OVC bits	6-70
ZAP	OVC	Clear overflow counter	6-395
DINT		Disable maskable interrupts (set INTM bit)	6-85
EINT		Enable maskable interrupt (clear INTM bit)	6-92
MOV	PM,AX	Load product shift mode bits PM = AX(2:0)	6-179
MOV	OVC,loc16	Load the overflow counter	6-176
MOVU	OVC,loc16	Load overflow counter with unsigned value	6-222
MOV	loc16,OVC	Store the overflow counter	6-173
MOVU	loc16,OVC	Store the unsigned overflow counter	6-221
SETC	Mode	Set multiple status bits	6-320
SETC	XF	Set XF bit and output signal	6-324
SETC	M0M1MAP	Set M0M1MAP bit	6-65
C28MAP		Set the M0M1MAP bit	6-322
SETC	OBJMODE	Set OBJMODE bit	6-66
C28OBJ		Set the OBJMODE bit	6-323
SETC	AMODE	Set AMODE bit	
LPADDR		Alias for SETC AMODE	6-129
SPM	PM	Set product shift mode bits	6-327
<b>Miscellaneous Operations</b>			
ABORTI		Abort interrupt	6-18
ASP		Align stack pointer	6-52
EALLOW		Enable access to protected space	6-90
IDLE		Put processor in IDLE mode	6-98
NASP		Un-align stack pointer	6-243
NOP	{*ind}	No operation with optional indirect address modification	6-250

Table 6–2. Register Operations (Continued)

<b>Mnemonic</b>	<b>Description</b>	<b>Page</b>
ZAPA	Zero accumulator P register and OVC	6-396
EDIS	Disable access to protected space	6-91
<b>Miscellaneous Operations (Continued)</b>		
ESTOP0	Emulation Stop 0	6-93
ESTOP1	Emulation Stop 1	6-94

**ABORTI**

*Abort Interrupt*

SYNTAX OPTIONS	OPCODE	OBJMODE	RPT	CYC
ABORTI	0000 0000 0000 0001	X	-	2

**Operands**                      None

**Description**                      Abort interrupt. This instruction is available for emulation purposes. Generally, a program uses the IRET instruction to return from an interrupt. The IRET instruction restores all of the values that were saved to the stack during the automatic context save. In restoring status register ST1 and the debug status register (DBGSTAT), IRET restores the debug context that was present before the interrupt.

In some target applications, you might have interrupts that must not be returned from by the IRET instruction. Not using IRET can cause a problem for the emulation logic, because the emulation logic assumes that the original debug context will be restored. The abort interrupt (ABORTI) instruction is provided as a means to indicate that the debug context will not be restored and the debug logic needs to be reset to its default state. As part of its operation, the ABORTI instruction:

- Sets the DBGM bit in ST1. This disables debug events.
- Modifies select bits in the DBGSTAT register. This effect is a resetting of the debug context. If the CPU was in the debug-halt state before the interrupt occurred, the CPU does not halt when the interrupt is aborted.

The ABORTI instruction does not modify the DBGIER, the IER, the INTM bit or any analysis registers (for example, registers used for breakpoints, watch points, and data logging).

**Flags and Modes**                      **DBGM**      The DBGM bit is set.

**Repeat**                                      This instruction is not repeatable. If this instruction follows the RPT instruction, it resets the repeat counter (RPTC) and executes only once.

**ABS ACC***Absolute Value of Accumulator*

SYNTAX OPTIONS	OPCODE	OBJMODE	RPT	CYC
ABS ACC	1111 1111 0101 0110	X	-	1

**Operands**    **ACC**    Accumulator register

**Description**                    The content of the ACC register is replaced with its absolute value:

```

if (ACC = 0x8000 0000)
  V = 1;
  If (OVM = 1)
    ACC = 0x7FFF FFFF;
  else
    ACC = 0x8000 0000;
else
  if (ACC < 0)
    ACC = -ACC;

```

**Flags and Modes**

**N**    After the operation, the N flag is set if bit 31 of the ACC is 1, else N is cleared.

**Z**    After the operation, the Z flag is set if the ACC is zero, else Z is cleared.

**C**    C is cleared by this operation.

**V**    If (ACC = 0x8000 0000) at the start of the operation, this is considered an overflow value and V is set. Otherwise, V is not affected.

**OVM**    If (ACC = 0x8000 0000) at the start of the operation, this is considered an overflow value, and the ACC value after the operation depends on the state of OVM: If OVM is cleared, ACC will be filled with 0x8000 0000. If OVM is set ACC will be saturated to 0x7FFF FFFF.

**Repeat**                            This instruction is not repeatable. If this instruction follows the RPT instruction, it resets the repeat counter (RPTC) and executes only once.

**Example**                    ; Take absolute value of VarA, make sure value is saturated:

```

MOVL  ACC,@VarA                    ; Load ACC with contents of VarA
SETC  OVM                            ; Turn overflow mode on
ABS   ACC                            ; Absolute of ACC and saturate
MOVL  @VarA,ACC                    ; Store result into VarA

```



**ABSTC ACC**

*Absolute Value of Accumulator and Load TC*

SYNTAX OPTIONS	OPCODE	OBJMODE	RPT	CYC
ABSTC ACC	0101 0110 0101 1111	1	-	1

**Operands**    **ACC**    Accumulator register

**Description**                    Replace the content of the ACC register with its absolute value and load the test control (TC) bit with the sign bit XORed with the previous value of the test control bit:

```

if (ACC = 0x8000 0000)
{
  If (OVM = 1)
    ACC = 0x7FFF FFFF;
  else
    ACC = 0x8000 0000;
  V = 1;
  TC = TC XOR 1;
}
else
{
  if (ACC < 0)
    ACC = -ACC;
  TC = TC XOR 1;
}
C = 0;

```

- Flags and Modes**
- N**    After the operation, the N flag is set if bit 31 of the ACC is 1, else N is cleared.
  - Z**    After the operation, the Z flag is set if the ACC is zero, else Z is cleared.
  - C**    The C flag bit is cleared.
  - V**    If (ACC = 0x8000 0000) at the start of the operation, this is considered an overflow value and V is set; otherwise, V is not affected.
  - TC**    If (ACC < 0) at the start of the operation, then TC = TC XOR 1; otherwise, TC is not affected.
  - OVM**    If at the start of the operation, ACC = 0x8000 0000, then this is considered an overflow value and the ACC value after the operation depends on OVM. If OVM is cleared and TC == 1, ACC will be filled with 0x8000 0000. If OVM is set and TC = 1, ACC will be saturated to 0x7FFF FFFF.

**Repeat**                            This instruction is not repeatable. If this instruction follows the RPT instruction, it resets the repeat counter (RPTC) and executes only once.

```

Example      ; Calculate signed: Quot16 = Num16/Den16, Rem16 = Num16%Den16
CLRC  TC                ; Clear TC flag, used as sign flag
MOV   ACC,@Den16 << 16  ; AH = Den16, AL = 0
ABSTC ACC              ; Take abs value, TC = sign ^ TC
MOV   T,@AH            ; Temp save Den16 in T register
MOV   ACC,@Num16 << 16  ; AH = Num16, AL = 0
ABSTC ACC              ; Take abs value, TC = sign ^ TC
MOVU  ACC,@AH          ; AH = 0, AL = Num16
RPT   #15              ; Repeat operation 16 times
||SUBCU ACC,@T         ; Conditional subtract with Den16
MOV   @Rem16,AH        ; Store remainder in Rem16
MOV   ACC,@AL << 16    ; AH = Quot16, AL = 0
NEGTC ACC              ; Negate if TC = 1
MOV   @Quot16,AH      ; Store quotient in Quot16

```

**ADD ACC,#16bit<<#0..15**

*Add Value to Accumulator*

SYNTAX OPTIONS	OPCODE	OBJMODE	RPT	CYC
ADD ACC,#16bit<<#0..15	1111 1111 0001 SHFT CCCC CCCC CCCC CCCC	X	-	1

**Operands**

- ACC** Accumulator register
- #16bit** 16-bit immediate constant value
- #0..15** Shift value (default is "<< #0" if no value specified)

**Description** Add the left shifted 16-bit immediate constant value to the ACC register. The shifted value is sign extended if sign extension mode is turned on (SXM = 1) else the shifted value is zero extended (SXM = 0). The lower bits of the shifted value are zero filled:

```

if(SXM = 1)    // sign extension mode enabled
    ACC = ACC + S:16bit << shift value;
else          // sign extension mode disabled
    ACC = ACC + 0:16bit << shift value;
    
```

**Smart Encoding:**

If #16bit is an 8-bit number and the shift is 0, then the assembler will encode this instruction as ADDDB ACC, #8bit to improve efficiency. To override this encoding, use the ADDDW ACC, #16bit instruction alias.

**Flags and Modes**

- Z** After the addition, the Z flag is set if the ACC value is zero, else the flag is cleared.
- N** After the addition, the N flag is set if bit 31 of the ACC is 1, else the flag is cleared.
- C** If the addition generates a carry, C is set; otherwise C is cleared.
- V** If an overflow occurs, V is set; otherwise V is not affected.
- OVC** If (OVM = 0, disabled) then if the operation generates a positive overflow, then the counter is incremented and if the operation generates a negative overflow, then the counter is decremented. If (OVM = 1, enabled) then the counter is not affected by the operation.
- SXM** If sign extension mode bit is set; then the 16-bit immediate constant will be sign-extended before the addition. Else, the value will be zero extended.
- OVM** If overflow mode bit is set; then the ACC value will saturate maximum positive (0x7FFFFFFF) or maximum negative (0x80000000) if the operation overflowed.

**Repeat** This instruction is not repeatable. If this instruction follows the RPT instruction, it resets the repeat counter (RPTC) and executes only once.

**Example**     ; Calculate signed value: ACC = (VarB << 10) + (23 << 6);  
SETC SXM                     ; Turn sign extension mode on  
MOV ACC,@VarB << #10       ; Load ACC with VarB left shifted by 10  
ADD ACC,#23 << #6           ; Add 23 left shifted by 6 to ACC

**ADD ACC,loc16 << T**

*Add Value to Accumulator*

SYNTAX OPTIONS	OPCODE	OBJMODE	RPT	CYC
ADD ACC,loc16<< T	0101 0110 0010 0011 0000 0000 LLLL LLLL	1	Y	N+1

**Operands**    **ACC**    Accumulator register  
                  **loc16**    Addressing mode (see Chapter 5)  
                  **T**            Upper 16 bits of the multiplicand register, XT(31:16)

**Description**            Add to the ACC register the left-shifted contents of the 16-bit location pointed to by the "loc16" addressing mode. The shift value is specified by the four least significant bits of the T register, T(3:0) = shift value = 0..15. Higher order bits of T are ignored. The shifted value is sign extended if sign extension mode is turned on (SXM = 1) else the shifted value is zero extended (SXM = 0). The lower bits of the shifted value are zero filled:

```

if(SXM = 1)        // sign extension mode enabled
  ACC = ACC + S:[loc16] << T(3:0);
else               // sign extension mode disabled
  ACC = ACC + 0:[loc16] << T(3:0);

```

**Flags and Modes**

- Z**            After the addition, the Z flag is set if the ACC value is zero, else Z is cleared.
- N**            After the addition, the N flag is set if bit 31 of the ACC is 1, else N is cleared.
- C**            If the addition generates a carry, C is set; otherwise C is cleared.
- V**            If an overflow occurs, V is set; otherwise V is not affected.
- OVC**        If OVM = 0, disabled and the operation generates a positive overflow, then the counter is incremented; if the operation generates a negative overflow, then the counter is decremented. If OVM = 1, enabled, then the counter is not affected by the operation.
- SXM**        If sign extension mode bit is set; then the 16-bit operand, addressed by the "loc16" field, will be sign extended before the addition. Else, the value will be zero extended.
- OVM**        If overflow mode bit is set; then the ACC value will saturate maximum positive (0x7FFFFFFF) or maximum negative (0x80000000) if the operation overflowed.

**Repeat**                If this operation is repeated, then the instruction will be executed N+1 times. The state of the Z, N, C flags will reflect the final result. The V flag will be set if an intermediate overflow occurs. The OVC flag will count intermediate overflows, if overflow mode is disabled.

**Example**                ; Calculate signed value: ACC = (VarA << SB) + (VarB << SB)

```

SETC SXM                    ; Turn sign extension mode on
MOV  T,@SA                 ; Load T with shift value in SA
MOV  ACC,@VarA << T        ; Load in ACC shifted contents of VarA
MOV  T,@SB                 ; Load T with shift value in SB
ADD  ACC,@VarB << T        ; Add to ACC shifted contents of VarB

```

**ADD ACC,loc16 << #0..16***Add Value to Accumulator*

SYNTAX OPTIONS	OPCODE	OBJMODE	RPT	CYC
ADD ACC,loc16<<#0	1000 0001 LLLL LLLL	1	Y	N+1
ADD ACC,loc16 << #1..15	0101 0110 0000 0100 0000 SHFT LLLL LLLL	1	Y	N+1
ADD ACC,loc16 << #16	0000 0101 LLLL LLLL	X	Y	N+1
ADD ACC,loc16<<0...15	1010 SHFT LLLL LLLL	0	-	N+1

**Operands**

**ACC** Accumulator register

**loc16** Addressing mode (see Chapter 5)

**#0..16** Shift value (default is "<< #0" if no value specified)

**Description** Add the left shifted 16-bit location pointed to by the "loc16" addressing mode to the ACC register. The shifted value is sign extended if sign extension mode is turned on (SXM = 1) else the shifted value is zero extended (SXM = 0). The lower bits of the shifted value are zero filled:

```

if(SXM = 1)    // sign extension mode enabled
    ACC = ACC + S:[loc16] << shift value;
else          // sign extension mode disabled
    ACC = ACC + 0:[loc16] << shift value;

```

**Flags and Modes**

**Z** After the addition, the Z flag is set if ACC is zero, else Z is cleared.

**N** After the addition, the N flag is set if bit 31 of the ACC is 1, else N is cleared.

**C** If the addition generates a carry, C is set; otherwise C is cleared.  
*Exception:* If a shift of 16 is used, the ADD instruction can set C but not clear C.

**V** If an overflow occurs, V is set; otherwise V is not affected.

**OVC** If (OVM = 0, disabled) then if the operation generates a positive overflow, then the counter is incremented and if the operation generates a negative overflow, then the counter is decremented. If (OVM = 1, enabled) then the counter is not affected by the operation.

**SXM** If sign extension mode bit is set; then the 16-bit operand, addressed by the "loc16" field, will be sign extended before the addition. Else, the value will be zero extended.

**OVM** If overflow mode bit is set; then the ACC value will saturate maximum positive (0x7FFFFFFF) or maximum negative (0x80000000) if the operation overflowed.

**Repeat** If the operation is repeatable, then the instruction will be executed N+1 times. The state of the Z, N, C flags will reflect the final result. The V flag will be set if an intermediate overflow occurs. The OVC flag will count intermediate overflows, if overflow mode is disabled. If the operation is not repeatable, the instruction will execute only once.

*ADD ACC,loc16 << #0..16*

---

**Example**       ; Calculate signed value: ACC = VarA << 10 + VarB << 6;  
SETC SXM                               ; Turn sign extension mode on  
MOV ACC,@VarA << #10               ; Load ACC with VarA left shifted by 10  
ADD ACC,@VarB << #6               ; Add VarB left shifted by 6 to ACC

**ADD AX, loc16***Add Value to AX*

SYNTAX OPTIONS	OPCODE	OBJMODE	RPT	CYC
ADD AX, loc16	1001 010A LLLL LLLL	X	-	1

**Operands**

**AX** Accumulator high (AH) or accumulator low (AL) register

**loc16** Addressing mode (see Chapter 5)

**Description** Add the contents of the location pointed to by the "loc16" addressing mode to the specified AX register (AH or AL) and store the result in the AX register:

**Flags and Modes**

**N** After the addition, AX is tested for a negative condition. If bit 15 of AX is 1, then the negative flag bit is set, otherwise it is cleared.

**Z** After the addition, AX is tested for a zero condition. The zero flag bit is set if the operation results in AX = 0; otherwise it is cleared.

**C** If the addition generates a carry, C is set; otherwise, C is cleared.

**V** If an overflow occurs, V is set; otherwise V is not affected. Signed positive overflow occurs if the result crosses the max positive value (0x7FFF) in the positive direction. Signed negative overflow occurs if the result crosses the max negative value (0x8000) in the negative direction.

**Repeat** This instruction is not repeatable. If this instruction follows the RPT instruction, it resets the repeat counter (RPTC) and executes only once.

**Example**

```

; Add the contents of VarA with VarB and store in VarC
MOV  AL,@VarA           ; Load AL with contents of VarA
ADD  AL,@VarB           ; Add to AL contents of VarB
MOV  @VarC,AL           ; Store result in VarC

```



**ADD loc16, AX**

*Add AX to Specified Location*

SYNTAX OPTIONS	OPCODE	OBJMODE	RPT	CYC
ADD loc16, AX	0111 001A LLLL LLLL	X	-	1

**Operands**    **loc16**    Addressing mode (see Chapter 5)  
                  **AX**        Accumulator high (AH) or accumulator low (AL) register

**Description**            Add the contents of the specified AX register (AH or AL) to the location pointed to by the “loc16” addressing mode and store the results in location pointed to by “loc16”:

$$[\text{loc16}] = [\text{loc16}] + \text{AX};$$

This is a read-modify-write operation.

**Flags and Modes**    **N**        After the addition, [loc16] is tested for a negative condition. If bit 15 of [loc16] is 1, then the negative flag bit is set, otherwise it is cleared.

**Z**        After the addition, [loc16] is tested for a zero condition. The zero flag bit is set if the operation generates [loc16] = 0; otherwise it is cleared

**C**        If the addition generates a carry, C is set; otherwise C is cleared.

**V**        If an overflow occurs, V is set; otherwise V is not affected. Signed positive overflow occurs if the result crosses the max positive value (0x7FFF) in the positive direction. Signed negative overflow occurs if the result crosses the max negative value (0x8000) in the negative direction.

**Repeat**                    This instruction is not repeatable. If this instruction follows the RPT instruction, it resets the repeat counter (RPTC) and executes only once.

**Example**                    ; Add the contents of VarA to index register AR0:

```
MOV  AL,@VarA                ; Load AL with contents of VarA
ADD  @AR0,AL                 ; AR0 = AR0 + AL
; Add the contents of VarB to VarC:
MOV  AH,@VarB                ; Load AH with contents of VarB
ADD  @VarC,AH                ; VarC = VarC + AH
```

**ADD loc16,#16bitSigned***Add Constant to Specified Location*

SYNTAX OPTIONS	OPCODE	OBJMODE	RPT	CYC
ADD loc16,#16bitSigned	0000 1000 LLLL LLLL CCCC CCCC CCCC CCCC	X	-	1

**Operands**    **loc16**    Addressing mode (see Chapter 5)

**#16bit-Signed**    16-bit immediate signed constant value

**Description**                    Add the specified signed 16-bit immediate constant to the signed 16-bit content of the location pointed to by the "loc16" addressing mode and store the 16-bit result in the location pointed to by "loc16":

[loc16] = [loc16] + 16bitSigned;

Smart Encoding:

If loc16 = AL or AH and #16bitSigned is an 8-bit number then the assembler will encode this instruction as `ADDB AX, #16bitSigned` to improve efficiency. To override this encoding, use the `ADDW loc16, #16bitSigned` instruction alias.

**Flags and Modes**    **N**            After the addition, if bit 15 of [loc16] is 1, then the N bit is set; else N cleared.

**Z**            After the addition, if [loc16] is zero, the Z is set, else Z is cleared.

**C**            If the addition generates a carry, C is set; otherwise, C is cleared.

**V**            If an overflow occurs, V is set; otherwise, V is cleared.

**Repeat**                            This instruction is not repeatable. If this instruction follows the RPT instruction, it resets the repeat counter (RPTC) and executes only once.

**Example**                    ; Calculate:

```

; VarA = VarA + 10
; VarB = VarB - 3
ADD @VarA,#10                    ; VarA = VarA + 10
ADD @VarB,#-3                    ; VarB = VarB - 3

```

**ADDB ACC,#8bit**

*Add 8-bit Constant to Accumulator*

SYNTAX OPTIONS	OPCODE	OBJMODE	RPT	CYC
ADDB ACC,#8bit	0000 1001 cccc cccc	X	-	1

**Operands**    **ACC**    Accumulator register  
                  **#8bit**    8-bit immediate unsigned constant value

**Description**                    Add an 8-bit, zero-extended constant to the ACC register:  
    ACC = ACC + 0:8bit;

**Flags and Modes**

- Z**            After the addition, the Z flag is set if ACC is zero, else Z is cleared.
- N**            After the addition, the N flag is set if bit 31 of the ACC is 1, else N is cleared.
- C**            If the addition generates a carry, C is set; otherwise C is cleared.
- V**            If an overflow occurs, V is set; otherwise V is not affected.
- OVC**        If (OVM = 0, disabled) then if the operation generates a positive overflow, then the counter is incremented and if the operation generates a negative overflow, then the counter is decremented. If (OVM = 1, enabled) then the counter is not affected by the operation.
- OVM**        If overflow mode bit is set; then the ACC value will saturate maximum positive (0x7FFFFFFF) or maximum negative (0x80000000) if the operation overflowed.

**Repeat**                            This instruction is not repeatable. If this instruction follows the RPT instruction, it resets the repeat counter (RPTC) and executes only once.

**Example**                    ; Increment contents of 32-bit location VarA:  
                  MOVL ACC,@VarA                    ; Load ACC with contents of VarA  
                  ADDB ACC,#1                    ; Add 1 to ACC  
                  MOVL @VarA,ACC                    ; Store result back into VarA

**ADDB AX, #8bitSigned**

*Add 8-bit Constant to AX*

SYNTAX OPTIONS	OPCODE	OBJMODE	RPT	CYC
ADDB AX, #8bitSigned	1001 110A CCCC CCCC	X	-	1

**Operands**    **AX**            Accumulator high (AH) or accumulator low (AL) register  
                   **#8bit-Signed**        8-bit immediate signed 2s complement constant value (-128 to 127)

**Description**                    Add the sign extended 8-bit constant to the specified AX register (AH or AL) and store the result in the AX register:  
      $AX = AX + S:8bit;$

**Flags and Modes**    **N**            After the addition, AX is tested for a negative condition. If bit 15 of AX is 1, then the negative flag bit is set; otherwise it is cleared.  
     **Z**            After the addition, AX is tested for a zero condition. The zero flag bit is set if the operation results in AX = 0, otherwise it is cleared  
     **C**            If the addition generates a carry, C is set; otherwise C is cleared.  
     **V**            If an overflow occurs, V is set; otherwise V is not affected. Signed positive overflow occurs if the result crosses the max positive value (0x7FFF) in the positive direction. Signed negative overflow occurs if the result crosses the max negative value (0x8000) in the negative direction.

**Repeat**                            This instruction is not repeatable. If this instruction follows the RPT instruction, it resets the repeat counter (RPTC) and executes only once.

**Example**                        ; Add 2 to VarA and subtract 3 from VarB:

```

MOV  AL,@VarA           ; Load AL with contents of VarA
ADDB AL,#2              ; Add to AL the value 0x0002 (2)
MOV  @VarA,AL          ; Store result in VarA
MOV  AL,@VarB           ; Load AL with contents of VarB
ADDB AL,#-3            ; Add to AL the value 0xFFFFD (-3)
MOV  @VarB,AL          ; Store result in VarB

```

**ADDB SP, #7bit**

*Add 7-bit Constant to Stack Pointer*

SYNTAX OPTIONS	OPCODE	OBJMODE	RPT	CYC
ADDB SP, #7bit	1111 1110 0CCC CCCC	X	-	1

**Operands**    **SP**        Stack pointer  
                  **#7bit**      7-bit immediate unsigned constant value

**Description**            Add a 7-bit unsigned constant to SP and store the result in SP:  
                                    $SP = SP + 0:7bit;$

**Flags and Modes**            None

**Repeat**                    This instruction is not repeatable. If this instruction follows the RPT instruction, it resets the repeat counter (RPTC) and executes only once

**Example**

```

FuncA:                                ; Function with local variables on stack.
    ADDB SP, #N                        ; Reserve N 16-bit words of space for
                                        ; local variables on stack:
    .
    .
    .
    SUBB SP, #N                        ; Deallocate reserved stack space.
    LRETR                              ; Return from function.
    
```

**ADDB XARn, #7bit**

*Add 7-bit Constant to Auxiliary Register*

SYNTAX OPTIONS	OPCODE	OBJMODE	RPT	CYC
ADDB XARn, #7bit	1101 1nnn 0CCC CCCC	X	–	1

**Operands**    **XARn**    XAR0–XAR7, 32-bit auxiliary registers

**Description**                    Add a 7-bit unsigned constant to XARn and store the result in XARn:  

$$XARn = XARn + 0:7bit;$$

**Flags and Modes**                    None

**Repeat**                                This instruction is not repeatable. If this instruction follows the RPT instruction, it resets the repeat counter (RPTC) and executes only once.

**Example**

```

MOVL XAR1, #VarA           ; Initialize XAR1 pointer with address
                           ; of VarA
MOVL XAR2, *XAR1          ; Load XAR2 with contents of VarA
ADDB XAR2, #10h           ; XAR2 = VarA + 0x10
    
```

**ADDCL ACC,loc32**

*Add 32-bit Value Plus Carry to Accumulator*

SYNTAX OPTIONS	OPCODE	OBJMODE	RPT	CYC
ADDCL ACC,loc32	0101 0110 0100 0000 xxxx xxxx LLLL LLLL	1	-	1

**Operands**    **ACC**    Accumulator register  
                  **loc32**    Addressing mode (see Chapter 5)

**Description**                    Add to the ACC register the 32-bit content of the location pointed to by the "loc32" addressing mode:

$$ACC = ACC + [loc32] + C;$$

**Flags and Modes**

- Z**            After the addition, the Z flag is set if the ACC is zero, else Z is cleared.
- N**            After the addition, the N flag is set if bit 31 of the ACC is 1, else N is cleared.
- C**            The state of the carry bit before execution is included in the addition. If the addition generates a carry, C is set; otherwise C is cleared.
- V**            If an overflow occurs, V is set; otherwise V is not affected.
- OVC**        If (OVM = 0, disabled) then if the operation generates a positive overflow, then the counter is incremented and if the operation generates a negative overflow, then the counter is decremented. If (OVM = 1, enabled) then the counter is not affected by the operation.
- OVM**        If overflow mode bit is set; then the ACC value will saturate maximum positive (0x7FFFFFFF) or maximum negative (0x80000000) if the operation overflows.

**Repeat**                            This instruction is not repeatable. If this instruction follows the RPT instruction, it resets the repeat counter (RPTC) and executes only once.

**Example**

```

; Add two 64-bit values (VarA and VarB) and store result in VarC:
MOVL  ACC,@VarA+0           ; Load ACC with contents of the low
                             ; 32 bits of VarA
ADDUL  ACC,@VarB+0           ; Add to ACC the contents of the low
                             ; 32 bits of VarB
MOVL  @VarC+0,ACC           ; Store low 32-bit result into VarC
MOVL  ACC,@VarA+2           ; Load ACC with contents of the high
                             ; 32 bits of VarA
ADDCL  ACC,@VarB+2           ; Add to ACC the contents of the high
                             ; 32 bits of VarB with carry
MOVL  @VarC+2,ACC           ; Store high 32-bit result into VarC
    
```

**ADDCU ACC,loc16**

*Add Unsigned Value Plus Carry to Accumulator*

SYNTAX OPTIONS	OPCODE	OBJMODE	RPT	CYC
ADDCU ACC,loc16	0000 1100 LLLL LLLL	X	-	1

**Operands**    **ACC**        Accumulator register  
                  **loc16**        Addressing mode (see Chapter 5)

**Description**                    Add the 16-bit contents of the location pointed to by the “loc16” addressing mode, zero extended, plus the content of the carry flag bit to the ACC register:

$$ACC = ACC + 0:[loc16] + C;$$

**Flags and Modes**

**Z**                    After the addition, the Z flag is set if the ACC value is zero, else Z is cleared.

**N**                    After the addition, the N flag is set if bit 31 of the ACC is 1, else N is cleared.

**C**                    The state of the carry bit before execution is included in the addition. If the addition generates a carry, C is set; otherwise C is cleared.

**V**                    If an overflow occurs, V is set; otherwise V is not affected.

**OVC**                If (OVM = 0, disabled) then if the operation generates a positive overflow, then the counter is incremented and if the operation generates a negative overflow, then the counter is decremented. If (OVM = 1, enabled) then the counter is not affected by the operation.

**OVM**                If overflow mode bit is set; then the ACC value will saturate maximum positive (0x7FFFFFFF) or maximum negative (0x80000000) if the operation overflowed.

**Repeat**                            This instruction is not repeatable. If this instruction follows the RPT instruction, it resets the repeat counter (RPTC) and executes only once.

**Example**                    ; Add three 32-bit unsigned variables by 16-bit parts:

```

MOVU ACC,@VarALow                    ; AH = 0, AL = VarALow
ADD ACC,@VarAhigh << 16            ; AH = VarAhigh, AL = VarALow
ADDU ACC,@VarBlow                   ; ACC = ACC + 0:VarBlow
ADD ACC,@VarBhigh << 16            ; ACC = ACC + VarBhigh << 16
ADDCU ACC,@VarClow                 ; ACC = ACC + VarClow + Carry
ADD ACC,@VarChigh << 16            ; ACC = ACC + VarChigh << 16

```



**ADDL ACC,loc32**

*Add 32-bit Value to Accumulator*

SYNTAX OPTIONS	OPCODE	OBJMODE	RPT	CYC
ADDL ACC,loc32	0000 0111 LLLL LLLL	X	Y	N+1

**Operands**    **ACC**    Accumulator register  
                  **loc32**    Addressing mode (see Chapter 5)

**Description**                    Add to the ACC register the 32-bit content of the location pointed to by the "loc32" addressing mode:  
     $ACC = ACC + [loc32];$

**Flags and Modes**

- N**            After the addition, the N flag is set if bit 31 of the ACC is 1, else N is cleared.
- Z**            After the addition, the Z flag is set if the ACC is zero, else Z is cleared.
- C**            If the addition generates a carry, C is set; otherwise C is cleared.
- V**            If an overflow occurs, V is set; otherwise V is not affected.
- OCV**        If (OVM = 0, disabled) then if the operation generates a positive overflow, then the counter is incremented and if the operation generates a negative overflow, then the counter is decremented. If (OVM = 1, enabled) then the counter is not affected by the operation.
- OVM**        If overflow mode bit is set; then the ACC value will saturate maximum positive (0x7FFFFFFF) or maximum negative (0x80000000) if the operation overflows.

**Repeat**                            If this operation is repeated, then the instruction will be executed N+1 times. The state of the Z, N, C flags will reflect the final result. The V flag will be set if an intermediate overflow occurs. The OVC flag will count intermediate overflows, if overflow mode is disabled.

**Example**                    ; Calculate the 32-bit value: VarC = VarA + VarB  
                  MOVL ACC,@VarA                    ; Load ACC with contents of VarA  
                  ADDL ACC,@VarB                    ; Add to ACC the contents of VarB  
                  MOVL @VarC,ACC                    ; Store result into VarC

**ADDL ACC,P << PM**

*Add Shifted P to Accumulator*

SYNTAX OPTIONS	OPCODE	OBJMODE	RPT	CYC
ADDL ACC,P << PM	0001 0000 1010 1100	X	Y	N+1

**Note:** This instruction is an alias for the "MOVA T,loc16" operation with "loc16 = @T" addressing mode.

**Operands**

**ACC** Accumulator register

**P** Product register

**<< PM** Product shift mode

**Description**

Add to the ACC register the contents of the P register, shifted as specified by the product shift mode (PM):

$ACC = ACC + P \ll PM$

**Flags and Modes**

**Z** After the addition, the N flag is set if bit 31 of the ACC is 1, else N is cleared.

**N** After the addition, the N flag is set if bit 31 of the ACC is 1, else N is cleared.

**C** If the addition generates a carry, C is set; otherwise C is cleared.

**V** If an overflow occurs, V is set; otherwise V is not affected.

**OCV** If (OVM = 0, disabled) then if the operation generates a positive overflow, then the counter is incremented and if the operation generates a negative overflow, then the counter is decremented. If (OVM = 1, enabled) then the counter is not affected by the operation.

**OVM** If overflow mode bit is set; then the ACC value will saturate maximum positive (0x7FFFFFFF) or maximum negative (0x80000000) if the operation overflowed.

**PM** The value in the PM bits sets the shift mode for the output operation from the product register. If the product shift value is positive (logical left shift operation), then the low bits are zero filled. If the product shift value is negative (arithmetic right shift operation), the upper bits are sign extended.

**Repeat**

If this operation is repeated, then the instruction will be executed N+1 times. The state of the Z, N, C flags will reflect the final result. The V flag will be set if an intermediate overflow occurs. The OVC flag will count intermediate overflows if overflow mode is disabled.

**Example**

```

; Calculate: Y = ((M*X >> 4) + (B << 11)) >> 10
; Y, M, X, B are Q15 values
SPM  -4                ; Set product shift to >> 4
SETC  SXM              ; Enable sign extension mode
MOV   T,@M             ; T = M
MPY   P,T,@X           ; P = M * X
MOV   ACC,@B << 11    ; ACC = S:B << 11
ADDL  ACC,P << PM     ; ACC = (M*X >> 4) + (S:B << 11)
MOVH  @Y,ACC << 5     ; Store Q15 result into Y
    
```

**ADDL loc32,ACC**

*Add Accumulator to Specified Location*

SYNTAX OPTIONS	OPCODE	OBJMODE	RPT	CYC
ADDL loc32, ACC	0101 0110 0000 0001 0000 0000 LLLL LLLL	1	-	1

**Operands**    **loc32**    Addressing mode (see Chapter 5)  
                   **ACC**        Accumulator register

**Description**                    Add to the ACC register the 32-bit content of the location pointed to by the “loc32” addressing mode:  
      $[loc32] = [loc32] + ACC;$   
     This is a read-modify-write operation.

**Flags and Modes**

- N**            After the addition, the N flag is set if bit 31 of the ACC is 1, else N is cleared.
- Z**            After the addition, the Z flag is set if the ACC is zero, else Z is cleared.
- C**            If the addition generates a carry, C is set; otherwise C is cleared.
- V**            If an overflow occurs, V is set; otherwise V is not affected.
- OCV**        If (OVM = 0, disabled) then if the operation generates a positive overflow, then the counter is incremented and if the operation generates a negative overflow, then the counter is decremented. If (OVM = 1, enabled) then the counter is not affected by the operation.
- OVM**        If overflow mode bit is set, the ACC value will saturate maximum positive (0x7FFFFFFF) or maximum negative (0x80000000) if the operation overflows.

**Repeat**                            This instruction is not repeatable. If this instruction follows the RPT instruction, it resets the repeat counter (RPTC) and executes only once.

**Example**                            ; Increment the 32-bit value VarA:  
                   MOVB ACC,#1                            ; Load ACC with 0x00000001  
                   ADDL @VarA,ACC                        ; VarA = VarA + ACC

**ADDU ACC,loc16**

*Add Unsigned Value to Accumulator*

SYNTAX OPTIONS	OPCODE	OBJMODE	RPT	CYC
ADDU ACC,loc16	0000 1101 LLLL LLLL	X	Y	N+1

**Operands**    **ACC**    Accumulator register  
                  **loc16**    Addressing mode (see Chapter 5)

**Description**            Add the 16-bit contents of the location pointed to by the “loc16” addressing mode to the ACC register. The addressed location is zero extended before the add:

$$ACC = ACC + 0:[loc16];$$

**Flags and Modes**

- Z**            After the addition, the Z flag is set if ACC is zero, else Z is cleared.
- N**            After the addition, the N flag is set if bit 31 of the ACC is 1, else N is cleared.
- C**            If the addition generates a carry, C is set; otherwise C is cleared.
- V**            If an overflow occurs, V is set; otherwise V is not affected.
- OVC**        If (OVM = 0, disabled) then if the operation generates a positive overflow, then the counter is incremented and if the operation generates a negative overflow, then the counter is decremented. If (OVM = 1, enabled) then the counter is not affected by the operation.
- OVM**        If overflow mode bit is set; then the ACC value will saturate maximum positive (0x7FFFFFFF) or maximum negative (0x80000000) if the operation overflowed.

**Repeat**                    If this operation is repeated, then the instruction will be executed N+1 times. The state of the Z, N, C flags will reflect the final result. The V flag will be set if an intermediate overflow occurs. The OVC flag will count intermediate overflows, if overflow mode is disabled.

**Example**            ; Add three 32-bit unsigned variables by 16-bit parts:  
 MOVU ACC,@VarAlow                    ; AH = 0, AL = VarAlow  
 ADD ACC,@VarAhigh << 16            ; AH = VarAhigh, AL = VarAlow  
 ADDU ACC,@VarBlow                    ; ACC = ACC + 0:VarBlow  
 ADD ACC,@VarBhigh << 16            ; ACC = ACC + VarBhigh << 16  
 ADDCU ACC,@VarClow                    ; ACC = ACC + VarClow + Carry  
 ADD ACC,@VarChigh << 16            ; ACC = ACC + VarChigh << 16

**ADDUL P,loc32**

*Add 32-bit Unsigned Value to P*

SYNTAX OPTIONS	OPCODE	OBJMODE	RPT	CYC
ADDUL P,loc32	0101 0110 0101 0111 0000 0000 LLLL LLLL	1	-	1

**Operands**    **P**            Product register  
                   **loc32**        Addressing mode (see Chapter 5)

**Description**            Add to the P register the 32-bit content of the location pointed to by the “loc32” addressing mode. The addition is treated as an unsigned ADD operation:

`P = P + [loc32];    // unsigned add`

**Note:** The difference between a signed and unsigned 32-bit add is in the treatment of the overflow counter (OVC). For a signed ADD, the OVC counter monitors positive/negative overflow. For an unsigned ADD, the OVC unsigned (OVCU) counter monitors the carry.

**Flags and Modes**        **N**            After the addition, if bit 31 of the P register is 1, then set the N flag; otherwise clear N.  
                               **Z**            After the addition, if the value of the P register is 0, then set the Z flag; otherwise clear Z.  
                               **C**            If the addition generates a carry, set C; otherwise C is cleared.  
                               **V**            If an overflow occurs, V is set; otherwise V is not affected.  
                               **OVCU**        The overflow counter is incremented when the addition operation generates an unsigned carry. The OVM mode does not affect the OVCU counter.

**Repeat**                    This instruction is not repeatable. If this instruction follows the RPT instruction, it resets the repeat counter (RPTC) and executes only once.

**Example**                 ; Add 64-bit VarA + VarB and store result in VarC:  
 MOVL P,@VarA+0            ; Load P with low 32 bits of VarA  
 MOVL ACC,@VarA+2         ; Load ACC with high 32 bits of VarA  
 ADDUL P,@VarB+0          ; Add to P unsigned low 32 bits of VarB  
 ADDCL ACC,@VarB+2        ; Add to ACC with carry high 32 bits of VarB  
 MOVL @VarC+0,P            ; Store low 32-bit result into VarC  
 MOVL @VarC+2,ACC         ; Store high 32-bit result into VarC

**ADDUL ACC, loc32***Add 32-bit Unsigned Value to Accumulator*

SYNTAX OPTIONS	OPCODE	OBJMODE	RPT	CYC
ADDUL ACC, loc32	0101 0110 0101 0011 xxxx xxxx LLLL LLLL	1	Y	N+1

**Operands**    **ACC**    Accumulator register                  **loc32**    Addressing mode (see Chapter 5)**Description**                    Add to the ACC register the unsigned 32-bit content of the location pointed to by the “loc32” addressing mode:

ACC = ACC + [loc32];    // unsigned add

**Note:** The difference between a signed and unsigned 32-bit add is in the treatment of the overflow counter (OVC). For a signed ADD, the OVC counter monitors positive/negative overflow. For an unsigned ADD, the OVC unsigned (OVCU) counter monitors the carry.

**Flags and Modes**

**Z**            After the addition, the Z flag is set if the ACC value is zero, else Z is cleared.

**N**            After the addition, the N flag is set if bit 31 of the ACC is 1, else N is cleared.

**C**            If the addition generates a carry, C is set; otherwise C is cleared.

**V**            If an overflow occurs, V is set; otherwise V is not affected.

**OVCU**        The overflow counter is incremented when the addition operation generates an unsigned carry. The OVM mode does not affect the OVCU counter.

**Repeat**                            If this operation is repeated, then the instruction will be executed N+1 times. The state of the Z, N, C flags will reflect the final result. The V flag will be set if an intermediate overflow occurs. The OVCU will count intermediate carries.

**Example**                    ; Add two 64-bit values (VarA and VarB) and store result in VarC:

```

MOVL  ACC,@VarA+0           ; Load ACC with contents of the low
                               ; 32 bits of VarA
ADDUL  ACC,@VarB+0           ; Add to ACC the contents of the low
                               ; 32 bits of VarB
MOVL  @VarC+0,ACC           ; Store low 32-bit result into VarC
MOVL  ACC,@VarA+2           ; Load ACC with contents of the high
                               ; 32 bits of VarA
ADDCL  ACC,@VarB+2           ; Add to ACC the contents of the high
                               ; 32 bits of VarB with carry
MOVL  @VarC+2,ACC           ; Store high 32-bit result into VarC

```

**ADRK #8bit**

*Add to Current Auxiliary Register*

SYNTAX OPTIONS	OPCODE	OBJMODE	RPT	CYC
ADRK #8bit	1111 1100 IIII IIII	X	-	1

**Operands**    **#8bit**    8-bit immediate constant value

**Description**                    Add the 8-bit unsigned constant to the XARn register pointed to by ARP:  
 $XAR(ARP) = XAR(ARP) + 0:8bit;$

**Flags and Modes**            **ARP**            The 3-bit ARP points to the current valid Auxiliary Register, XAR0 to XAR7. This pointer determines which Auxiliary register is modified by the operation.

**Repeat**                            This instruction is not repeatable. If this instruction follows the RPT instruction, it resets the repeat counter (RPTC) and executes only once

**Example**                    TableA: .word 0x1111  
                                   .word 0x2222  
                                   .word 0x3333  
                                   .word 0x4444

```
FuncA:
    MOVL XAR1,#TableA      ; Initialize XAR1 pointer
    MOVZ AR2,*XAR1         ; Load AR2 with the 16-bit value
                           ; pointed to by XAR1 (0x1111)
                           ; Set ARP = 1

    ADRK #2                ; Increment XAR1 by 2
    MOVZ AR3,*XAR1         ; Load AR3 with the 16-bit value
                           ; pointed to by XAR1 (0x3333)
```

**AND ACC,#16bit << #0..16***Bitwise AND*

SYNTAX OPTIONS	OPCODE	OBJMODE	RPT	CYC
AND ACC, #16bit << #0..15	0011 1110 0000 SHFT CCCC CCCC CCCC CCCC	1	-	1
AND ACC, #16bit << #16	0101 0110 0000 1000 CCCC CCCC CCCC CCCC	1	-	1

**Operands**

**ACC** Accumulator register

**#16bit** 16-bit immediate constant value

**#0..16** Shift value (default is "<< #0" if no value specified)

**Description** Perform a bitwise AND operation on the ACC register with the given 16-bit unsigned constant value left shifted as specified. The value is zero extended and lower order bits are zero filled before the AND operation. The result is stored in the ACC register:

ACC = ACC AND (0:16bit << shift value);

**Flags and Modes**

**N** The load to ACC is tested for a negative condition. If bit 31 of ACC is 1, then the negative flag bit is set; otherwise it is cleared.

**Z** The load to ACC is tested for a zero condition. The zero flag bit is set if the operation generates ACC = 0; otherwise it is cleared

**Repeat** This instruction is not repeatable. If this instruction follows the RPT instruction, it resets the repeat counter (RPTC) and executes only once.

**Example**

```
; Calculate the 32-bit value: VarA = VarA AND 0x0FFFF000
MOVL ACC,@VarA          ; Load ACC with contents of VarA
AND ACC,#0xFFFF << 12 ; AND ACC with 0x0FFFF000
MOVL @VarA,ACC          ; Store result in VarA
```



**AND ACC, loc16***Bitwise AND*

SYNTAX OPTIONS	OPCODE	OBJMODE	RPT	CYC
AND ACC, loc16	1000 1001 LLLL LLLL	1	Y	N+1

**Operands**    **ACC**    Accumulator register  
                  **loc16**    Addressing mode (see Chapter 5)

**Description**            Perform a bitwise AND operation on the ACC register with the zero-extended content of the location pointed to by the "loc16" address mode. The result is stored in the ACC register:

```
ACC = ACC AND 0:[loc16];
```

**Flags and**    **N**            Clear flag.

**Modes**        **Z**            The load to ACC is tested for a zero condition. The zero flag bit is set if the operation generates ACC = 0; otherwise it is cleared

**Repeat**                    This operation is repeatable. If the operation follows a RPT instruction, then the AND instruction will be executed N+1 times. The state of the Z and N flags will reflect the final result.

**Example**            ; Calculate the 32-bit value: VarA = VarA AND 0:VarB  
 MOVL ACC,@VarA            ; Load ACC with contents of VarA  
 AND ACC,@VarB            ; AND ACC with contents of 0:VarB  
 MOVL @VarA,ACC            ; Store result in VarA

**AND AX, loc16, #16bit***Bitwise AND*

SYNTAX OPTIONS	OPCODE	OBJMODE	RPT	CYC
AND AX, loc16, #16bit	1100 110A LLLL LLLL CCCC CCCC CCCC CCCC	X	-	1

**Operands**

**AX** Accumulator high (AH) or accumulator low (AL) register

**loc16** Addressing mode (see Chapter 5)

**#16bit** 16-bit immediate constant value

**Description** Perform a bitwise AND operation on the 16-bit contents of the location pointed to by the "loc16" addressing mode with the specified 16-bit immediate constant. The result is stored in the specified AX register:

AX = [loc16] AND 16bit;

**Flags and Modes**

**N** The load to AX is tested for a negative condition. If bit 15 of AX is 1, then the negative flag bit is set; otherwise it is cleared.

**Z** The load to AX is tested for a zero condition. The zero flag bit is set if the operation generates AX = 0; otherwise it is cleared

**Repeat** This instruction is not repeatable. If this instruction follows the RPT instruction, it resets the repeat counter (RPTC) and executes only once.

**Example**

```

; Branch if either of Bits 2 and 7 of VarA are non-zero:
AND AL,@VarA,#0x0084      ; AL = VarA AND 0x0084
SB  Dest,NEQ              ; Branch if result is non-zero
; Merge Bits 0,1,2 of VarA with Bits 8,9,10 of VarB and store in
; VarC in bit locations 0,1,2,3,4,5:
AND AL,@VarA,#0x0007      ; Keep bits 0,1,2 of VarA
AND AH,@VarB,#0x0700      ; Keep bits 8,9,10 of VarB
LSR AH,#5                 ; Scale back bits 8,9,10 to bits 3,4,5
OR  AL,@AH                ; Merge bits
MOV @VarC,AL              ; Store result in VarC

```

**AND IER,#16bit**

*Bitwise AND to Disable Specified CPU Interrupts*

SYNTAX OPTIONS	OPCODE	OBJMODE	RPT	CYC
AND IER,#16bit	0111 0110 0010 0110 CCCC CCCC CCCC CCCC	X	-	2

**Operands**    **IER**        Interrupt enable register  
                  **#16bit**    16-bit immediate constant value (0x0000 to 0xFFFF)

**Description**            Disable specific interrupts by performing a bitwise AND operation with the IER register and the 16-bit immediate value. The result is stored in the IER register:

IER = IER AND #16bit;

**Flags and Modes**            None

**Repeat**                    This instruction is not repeatable. If this instruction follows the RPT instruction, it resets the repeat counter (RPTC) and executes only once.

**Example**                    ; Disable INT1 and INT6 only. Do not modify state of other  
                  ; interrupts enable:  
                  AND IER,#0xFFDE                    ; Disable INT1 and INT6

**AND IFR,#16bit***Bitwise AND to Clear Pending CPU Interrupts*

SYNTAX OPTIONS	OPCODE	OBJMODE	RPT	CYC
AND IFR,#16bit	0111 0110 0010 1111 CCCC CCCC CCCC CCCC	X	-	2

**Operands**    **IFR**        Interrupt flag register  
                  **#16bit**    16-bit immediate constant value (0x0000 to 0xFFFF)

**Description**            Clear specific pending interrupts by performing a bitwise AND operation with the IFR register and the 16-bit immediate value. The result of the AND operation is stored in the IFR register:

IFR = IFR AND #16bit;

**Note:** Interrupt hardware has priority over CPU instruction operation in cases where the interrupt flag is being simultaneously modified by the hardware and the instruction.

**Flags and Modes**            None

**Repeat**                        This instruction is not repeatable. If this instruction follows the RPT instruction, it resets the repeat counter (RPTC) and executes only once.

**Example**                    ; Clear the contents of the IFR register. Disables all  
                  ; pending interrupts:  
                  AND IFR,#0x0000                    ; Clear IFR register

**AND loc16, AX***Bitwise AND*

SYNTAX OPTIONS	OPCODE	OBJMODE	RPT	CYC
AND loc16, AX	1100 000A LLLL LLLL	X	-	1

**Operands**

**loc16** Addressing mode (see Chapter 5)

**AX** Accumulator high (AH) or accumulator low (AL) register

**Description** Perform a bitwise AND operation on the contents of the location pointed to by the "loc16" addressing mode with the specified AX register. The result is stored in location pointed to by "loc16":

```
[loc16] = [loc16] AND AX;
```

This is a read-modify-write operation.

**Flags and Modes**

**N** The load to [loc16] is tested for a negative condition. If bit 15 of [loc16] is 1, then the negative flag bit is set; otherwise it is cleared.

**Z** The load to [loc16] is tested for a zero condition. The zero flag bit is set if the operation generates ([loc16] = 0); otherwise it is cleared.

**Repeat** This instruction is not repeatable. If this instruction follows the RPT instruction, it resets the repeat counter (RPTC) and executes only once.

**Example**

```
; AND the contents of VarA with VarB and store in VarB:
MOV  AL,@VarA           ; Load AL with contents of VarA
AND  @VarB,AL           ; VarB = VarB AND AL
```

**AND AX, loc16***Bitwise AND*

SYNTAX OPTIONS	OPCODE	OBJMODE	RPT	CYC
AND AX, loc16	1100 111A LLLL LLLL	X	-	1

**Operands**    **AX**        Accumulator high (AH) or accumulator low (AL) register  
                   **loc16**      Addressing mode (see Chapter 5)

**Description**            Perform a bitwise AND operation on the contents of the specified AX register with the 16-bit contents of the location pointed to by the "loc16" addressing mode. The result is stored in the AX register:

`AX = AX AND 16bit;`

**Flags and Modes**    **N**        The load to AX is tested for a negative condition. If bit 15 of AX is 1, then the negative flag bit is set; otherwise it is cleared.  
                               **Z**        The load to AX is tested for a zero condition. The zero flag bit is set if the operation generates AX = 0; otherwise it is cleared

**Repeat**                This instruction is not repeatable. If this instruction follows the RPT instruction, it resets the repeat counter (RPTC) and executes only once.

**Example**                ; AND the contents of VarA and VarB and branch if non-zero:  
                   MOV    AL,@VarA                                ; Load AL with contents of VarA  
                   AND    AL,@VarB                              ; AND AL with contents of VarB  
                   SB     Dest,NEQ                             ; Branch if result is non-zero

**AND loc16,#16bitSigned**

*Bitwise AND*

SYNTAX OPTIONS	OPCODE	OBJMODE	RPT	CYC
AND loc16,#16bitSigned	0001 1000 LLLL LLLL CCCC CCCC CCCC CCCC	X	-	1

**Operands**    **loc16**            Addressing mode (see Chapter 5)  
                  **#16bitSigned**    16-bit signed immediate constant value

**Description**                    Perform a bitwise AND operation on the 16-bit content of the location pointed to by the “loc16” addressing mode and the specified 16-bit immediate constant. The result is stored in the location pointed to by “loc16”:

[loc16] = [loc16] AND 16bit;

Smart Encoding:

If loc16 = AH or AL and #16bitSigned is an 8-bit number, then the assembler will encode this instruction as ANDB AX, #8-bit to improve efficiency. To override this, use the ANDW AX, #16bitSigned instruction alias.

**Flags and Modes**    **N**                    After the operation if bit 15 of [loc16] 1, set N; otherwise, clear N.  
                          **Z**                    After the operation if [loc16] is zero, set Z; otherwise, clear Z.

**Repeat**                            This instruction is not repeatable. If this instruction follows the RPT instruction, it resets the repeat counter (RPTC) and executes only once.

**Example**                            ; Clear Bits 3 and 11 of VarA:  
    ; VarA = VarA AND ~(1 << 3 | 1 << 11)  
    AND @VarA,#~(1 << 3 | 1 << 11) ; Clear bits 3 and 11 of VarA  
    << 11)

**ANDB AX, #8bit**

*Bitwise AND 8-bit Value*

SYNTAX OPTIONS	OPCODE	OBJMODE	RPT	CYC
ANDB AX, #8bit	1001 000A CCCC CCCC	X	-	1

**Operands**    **AX**        Accumulator high (AH) or accumulator low (AL) register  
                   **#8bit**        8-bit immediate constant value

**Description**            Perform a bitwise AND operation with the content of the specified AX register (AH or AL) with the given 8-bit unsigned immediate constant zero extended. The result is stored in AX:

$$AX = AX \text{ AND } 0:8\text{bit};$$

**Flags and Modes**    **N**        The load to AX is tested for a negative condition. If bit 15 of AX is 1, then the negative flag bit is set; otherwise it is cleared.  
                               **Z**        The load to AX is tested for a zero condition. The zero flag bit is set if the operation generates AX = 0; otherwise it is cleared

**Repeat**                    This instruction is not repeatable. If this instruction follows the RPT instruction, it resets the repeat counter (RPTC) and executes only once.

**Example**                ; Add VarA to VarB, keep LSByte and store result in VarC:  
                   MOV    AL,@VarA                    ; Load AL with contents of VarA  
                   ADD    AL,@VarB                    ; Add to AL contents of VarB  
                   ANDB  AL,#0xFF                ; AND contents of AL with 0x00FF  
                   MOV    @VarC,AL                ; Store result in VarC



**ASP***Align Stack Pointer*

SYNTAX OPTIONS	OPCODE	OBJMODE	RPT	CYC
ASP	0111 0110 0001 1011	X	-	1

**Operands**                None

**Description**            Ensure that the stack pointer (SP) is aligned to an even address. If the least significant bit of SP is 1, SP points to an odd address and must be moved by incrementing SP by 1. The SPA bit is set as a record of this alignment. If instead the ASP instruction finds that the SP already points to an even address, SP is left unchanged and the SPA bit is cleared to indicate that no alignment has taken place. In either case, the change to the SPA bit is made in the decode 2 phase of the pipeline.

```
if(SP = odd)
  SP = SP + 1;
  SPA = 1;else
  SPA = 0;
```

If you wish to undo a previous alignment by the ASP instruction, use the NASP instruction.

**Flags and Modes**        **SPA**    If SP holds an odd address before the operation, SPA is set; otherwise, SPA is cleared.

**Repeat**                    This instruction is not repeatable. If this instruction follows the RPT instruction, it resets the repeat counter (RPTC) and executes only once.

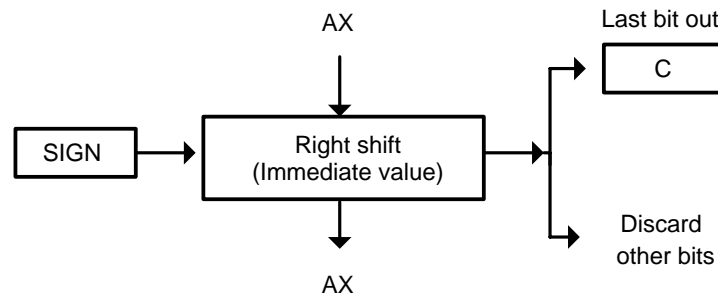
**Example**                ; Alignment of stack pointer in interrupt service routine:  
; Vector table:  
INTx: .long INTxService                ; INTx interrupt vector  
.  
.  
  
INTxService:  
  ASP                                    ; Align stack pointer  
  .  
  .  
  .  
  NASP                                 ; Re-align stack pointer  
  IRET                                 ; Return from interrupt.

**ASR AX,#1...16***Arithmetic Shift Right*

SYNTAX OPTIONS	OPCODE	OBJMODE	RPT	CYC
ASR AX,#1...16	1111 1111 101A SHFT	X	-	1

**Operands**    **AX**        Accumulator high (AH) or accumulator low (AL) register  
                   **1...16**      Shift value

**Description**        Perform an arithmetic right shift on the content of the specified AX register (AH or AL) by the amount given in the "shift value" field. During the shift, the value is sign extended and the last bit to be shifted out of the AX register is stored in the carry status flag bit:



**Flags and Modes**    **N**        After the shift, if bit 15 of AX is 1 then the negative flag bit is set; otherwise it is cleared.  
                           **Z**        After the shift, if AX is 0, then the Z bit is set; otherwise it is cleared.  
                           **C**        The last bit to be shifted out of AH or AL is stored in C.

**Repeat**                This instruction is not repeatable. If this instruction follows the RPT instruction, it resets the repeat counter (RPTC) and executes only once.

**Example**              ; Calculate signed value: VarC = (VarA + VarB) >> 2  
 MOV AL,@VarA            ; Load AL with contents of VarA  
 ADD AL,@VarB            ; Add to AL contents of VarB  
 ASR AL,#2                ; Scale result by 2  
 MOV @VarC,AL            ; Store result in VarC

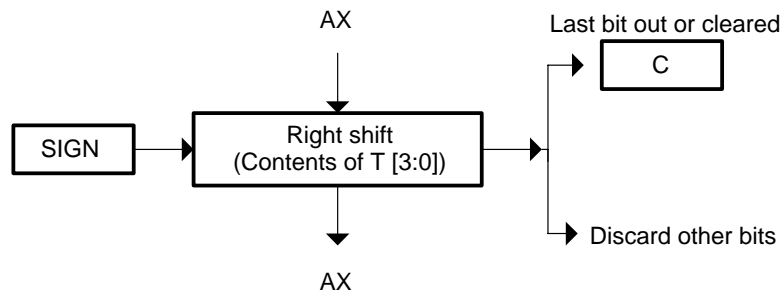
**ASR AX,T**

*Arithmetic Shift Right*

SYNTAX OPTIONS	OPCODE	OBJMODE	RPT	CYC
ASR AX,T	1111 1111 0110 010A	X	-	1

**Operands**    **AX**    Accumulator high (AH) or accumulator low (AL) register  
                   **T**        Upper 16 bits of the multiplicand (XT) register

**Description**            Perform an arithmetic shift right on the content of the specified AX register as specified by the four least significant bits of the T register, T(3:0) = shift value = 0...15. The contents of higher order bits are ignored. During the shift, the value is sign extended. If the T(3:0) register bits specify a shift of 0, then C is cleared; otherwise, C is filled with the last bit to be shifted out of AX:



**Flags and Modes**    **N**    After the shift, if bit 15 of AX is 1 then the negative flag bit is set; otherwise it is cleared. Even if the T(3:0) register bits specify a shift of 0, the value of AH or AL is still tested for the negative condition and N is affected.  
                           **Z**    After the shift, if AX is 0, then the Z bit is set, otherwise it is cleared. Even if the T(3:0) register bits specify a shift of 0, the value of AH or AL is still tested for the zero condition and Z is affected.  
                           **C**    If T(3:0) specifies a shift of 0, then C is cleared; otherwise, C is filled with the last bit to be shifted out of AH or AL.

**Repeat**                    This instruction is not repeatable. If this instruction follows the RPT instruction, it resets the repeat counter (RPTC) and executes only once.

```

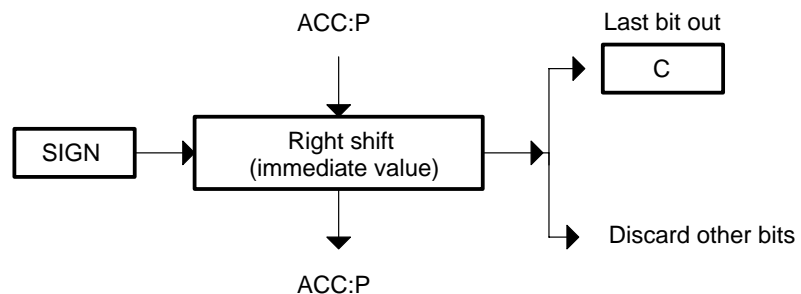
Example            ; Calculate signed value: VarC = VarA >> VarB;
MOV    T,@VarB                            ; Load T with contents of VarB
MOV    AL,@VarA                          ; Load AL with contents of VarA
ASR    AL,T                                ; Scale AL by value in T bits 0 to 3
MOV    @VarC,AL                          ; Store result in VarC
    
```

**ASR64 ACC:P,#1..16***Arithmetic Shift Right of 64-bit Value*

SYNTAX OPTIONS	OPCODE	OBJMODE	RPT	CYC
ASR64 ACC:P,#1..16	0101 0110 1000 SHFT	1	-	1

**Operands**    **ACC:P**    Accumulator register (ACC) and product register (P)  
                   **#1..16**    Shift value

**Description**            Arithmetic shift right the 64-bit combined value of the ACC:P registers by the amount specified in the shift value field. As the value is shifted, the most significant bits are sign extended and the last bit shifted out is stored in the carry bit flag:



**Flags and Modes**    **N**            After the shift, if bit 31 of the ACC register is 1 then ACC:P is negative and the N bit is set; otherwise N is cleared.

**Z**            After the shift, the Z flag is set if the combined 64-bit value of the ACC:P is zero; otherwise, Z is cleared.

**C**            The last bit shifted out of the combined 64-bit value is loaded into the C bit.

**Repeat**                    This instruction is not repeatable. If this instruction follows the RPT instruction, it resets the repeat counter (RPTC) and executes only once.

**Example**                ; Arithmetic shift right the 64-bit Var64 by 10:  
 MOVL ACC,@Var64+2            ; Load ACC with high 32 bits of Var64  
 MOVL P,@Var64+0             ; Load P with low 32 bits of Var64  
 ASR64 ACC:P,#10             ; Arithmetic shift right ACC:P by 10  
 MOVL @Var64+2,ACC           ; Store high 32-bit result into Var64  
 MOVL @Var64+0,P             ; Store low 32-bit result into Var64

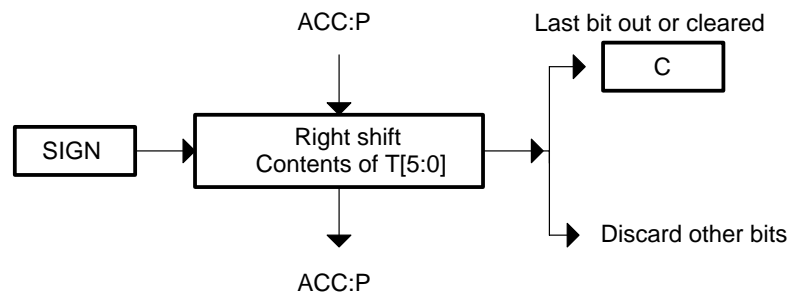
**ASR64 ACC:P,T***Arithmetic Shift Right of 64-bit Value*

SYNTAX OPTIONS	OPCODE	OBJMODE	RPT	CYC
ASR64 ACC:P,T	0101 0110 0010 1100	1	-	1

**Operands**    **ACC:P**    Accumulator register (ACC) and product register (P)

**T**            Upper 16 bits of the multiplicand register (XT)

**Description**            Arithmetic shift right the 64-bit combined value of the ACC:P registers by the amount specified in six least significant bits of the T register, T(5:0) = 0...63. Higher order bits are ignored. As the value is shifted, the most significant bits are sign extended. If T specifies a shift of 0, then C is cleared; otherwise, C is filled with the last bit to be shifted out of the ACC:P registers:



**Flags and Modes**    **N**            After the shift, if bit 31 of the ACC register is 1 then ACC:P is negative and the N bit is set; otherwise N is cleared.

**Z**            After the shift, the Z flag is set if the combined 64-bit value of the ACC:P is zero; otherwise, Z is cleared.

**C**            If (T[5:0] = 0) clear C; otherwise, the last bit shifted out of the combined 64-bit value is loaded into the C bit.

**Repeat**                    This instruction is not repeatable. If this instruction follows the RPT instruction, it resets the repeat counter (RPTC) and executes only once.

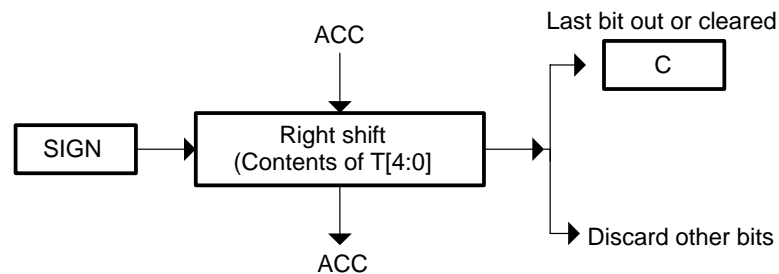
**Example**                ; Arithmetic shift right the 64-bit Var64 by contents of Var16:  
 MOVL ACC,@Var64+2            ; Load ACC with high 32 bits of Var64  
 MOVL P,@Var64+0            ; Load P with low 32 bits of Var64  
 MOV T,@Var16                ; Load T with shift value from Var16  
 ASR64 ACC:P,T                ; Arithmetic shift right ACC:P by T(5:0)  
 MOVL @Var64+2,ACC            ; Store high 32-bit result into Var64  
 MOVL @Var64+0,P             ; Store low 32-bit result into Var64

**ASRL ACC,T***Arithmetic Shift Right of Accumulator*

SYNTAX OPTIONS	OPCODE	OBJMODE	RPT	CYC
ASRL ACC,T	0101 0110 0001 0000	1	-	1

**Operands**    **ACC**    Accumulator register  
                   **T**        Upper 16 bits of the multiplicand (XT) register

**Description**            Perform an arithmetic shift right on the content of the ACC register as specified by the five least significant bits of the T register, T(4:0) = 0...31. Higher order bits are ignored. During the shift, the value is sign extended. If T specifies a shift of 0, then C is cleared; otherwise, C is filled with the last bit to be shifted out of the ACC register:



**Flags and Modes**    **Z**        After the shift, the Z flag is set if the ACC value is zero, else Z is cleared. Even if the T register specifies a shift of 0, the content of the ACC register is still tested for the zero condition and Z is affected.

**N**        After the shift, the N flag is set if bit 31 of the ACC is 1, else N is cleared. Even if the T register specifies a shift of 0, the content of the ACC register is still tested for the negative condition and N is affected.

**C**        If (T(4:0) = 0) then C is cleared; otherwise, the last bit shifted out is loaded into the C flag bit.

**Repeat**                This instruction is not repeatable. If this instruction follows the RPT instruction, it resets the repeat counter (RPTC) and executes only once.

**Example**                ; Arithmetic shift right contents of VarA by VarB:  
                   `MOVL ACC,@VarA                ; ACC = VarA`  
                   `MOV T,@VarB                    ; T = VarB (shift value)`  
                   `ASRL ACC,T                     ; Arithmetic shift right ACC by T(4:0)`  
                   `MOVL @VarA,ACC                ; Store result into VarA`

**B 16bitOffset,COND**

Branch

SYNTAX OPTIONS	OPCODE	OBJMODE	RPT	CYC
B 16bitOffset,COND	1111 1111 1110 COND CCCC CCCC CCCC CCCC	X	-	7/4

**Operands**    **16bit-Offset**    16-bit signed immediate constant offset value (-32768 to +32767 range)  
**COND**                    Conditional codes:

COND	Syntax	Description	Flags Tested
0000	NEQ	Not Equal To	Z = 0
0001	EQ	Equal To	Z = 1
0010	GT	Greater Than	Z = 0 AND N = 0
0011	GEQ	Greater Than Or Equal To	N = 0
0100	LT	Less Than	N = 1
0101	LEQ	Less Than Or Equal To	Z = 1 OR N = 1
0110	HI	Higher	C = 1 AND Z = 0
0111	HIS, C	Higher Or Same, Carry Set	C = 1
1000	LO, NC	Lower, Carry Clear	C = 0
1001	LOS	Lower Or Same	C = 0 OR Z = 1
1010	NOV	No Overflow	V = 0
1011	OV	Overflow	V = 1
1100	NTC	Test Bit Not Set	TC = 0
1101	TC	Test Bit Set	TC = 1
1110	NBIO	BIO Input Equal To Zero	BIO = 0
1111	UNC	Unconditional	-

**Description**                    Conditional branch. If the specified condition is true, then branch by adding the signed 16-bit constant value to the current PC value; otherwise continue execution without branching:

If (COND = true) PC = PC + signed 16-bit offset;  
 If (COND = false) PC = PC + 2;

**Note:** If (COND = true) then the instruction takes 7 cycles.  
 If (COND = false) then the instruction takes 4 cycles.

**Flags and Modes**            **V**                    If the V flag is tested by the condition, then V is cleared.

**Repeat**                        This instruction is not repeatable. If this instruction follows the RPT instruction, it resets the repeat counter (RPTC) and executes only once.

**BANZ 16bitOffset,ARn--***Branch if Auxiliary Register Not Equal to Zero*

SYNTAX OPTIONS	OPCODE	OBJMODE	RPT	CYC
BANZ 16bitOffset,ARn--	0000 0000 0000 1nnn CCCC CCCC CCCC CCCC	X	-	4/2

**Operands**    **16bit-Offset**    16-bit signed immediate constant value

**ARn**            Lower 16 bits of auxiliary registers XAR0 to XAR7

**Description**            If the 16-bit content of the specified auxiliary register is not equal to 0, then the 16-bit sign offset is added to the PC value. This forces program control to the new address (PC + 16bitOffset). The 16-bit offset is sign extended to 22 bits before the addition. Then, the content of the auxiliary register is decremented by 1. The upper 16 bits of the auxiliary register (ARnH) is not used in the comparison and is not affected by the post decrement:

```
if( ARn != 0 )
    PC = PC + signed 16-bit offset;
ARn = ARn - 1;
ARnH = unchanged;
```

**Note:** If branch is taken, then the instruction takes 4 cycles  
If branch is not taken, then the instruction takes 2 cycles

**Flags and Modes**            None

**Repeat**                    This instruction is not repeatable. If this instruction follows the RPT instruction, it resets the repeat counter (RPTC) and executes only once.

**Example**                    ; Copy the contents of Array1 to Array2:

```
; int32 Array1[N];
; int32 Array2[N];
; for(i=0; i < N; i++)
;   Array2[i] = Array1[i];
MOVL  XAR2,#Array1           ; XAR2 = pointer to Array1
MOVL  XAR3,#Array2           ; XAR3 = pointer to Array2
MOV   @AR0,#(N-1)            ; Repeat loop N times
Loop:
MOVL  ACC,*XAR2++             ; ACC = Array1[i]
MOVL  *XAR3++,ACC             ; Array2[i] = ACC
BANZ  Loop,AR0--              ; Loop if AR0 != 0, AR0--
```



**BAR 16bitOffset,ARn,ARm,EQ/NEQ**

*Branch on Auxiliary Register Comparison*

SYNTAX OPTIONS	OPCODE	OBJMODE	RPT	CYC
BAR 16bitOffset,ARn,ARm,EQ	1000 1111 10nn nmmm CCCC CCCC CCCC CCCC	1	-	4/2
BAR 16bitOffset,ARn,ARm,NEQ	1000 1111 11nn nmmm CCCC CCCC CCCC CCCC	1	-	4/2

<b>Operands</b>	<b>16bit-Offset</b>	16-bit signed immediate constant offset value (-32768 to +32767 range)
	<b>ARn</b>	Lower 16 bits of auxiliary registers XAR0 to XAR7
	<b>ARm</b>	Lower 16 bits of auxiliary registers XAR0 to XAR7
<b>Syntax</b>	<b>Description</b>	<b>Condition Tested</b>
NEQ	Not Equal To	ARn != ARm
EQ	Equal To	ARn = ARm

**Description** Compare the 16-bit contents of the two auxiliary registers ARn and ARm registers and branch if the specified condition is true; otherwise continue execution without branching:

If (tested condition = true) PC = PC + signed 16-bit offset;  
 If (tested condition = false) PC = PC + 2;

**Note:** If (tested condition = true) then the instruction takes 4 cycles.  
 If (tested condition = false) then the instruction takes 2 cycles.

**Flags and Modes** None

**Repeat** This instruction is not repeatable. If this instruction follows the RPT instruction, it resets the repeat counter (RPTC) and executes only once.

**Example**

```

; String compare:
MOVL XAR2,#StringA          ; XAR2 points to StringA
MOVL XAR3,#StringB          ; XAR3 points to StringB
MOV  @AR4,#0                 ; AR4 = 0
Loop:
MOVZ AR0,*XAR2++             ; AR0 = StringA[i]
MOVZ AR1,*XAR3++             ; AR1 = StringB[i], i++
BAR  Exit,AR0,AR4,EQ          ; Exit if StringA[i] = 0
BAR  Loop,AR0,AR1,EQ          ; Loop if StringA[i] = StringB[i]
NotEqual:                     ; StringA and B not the same
.
Exit:                          ; StringA and B the same
    
```

## BF 16bitOffset,COND

Branch Fast

SYNTAX OPTIONS	OPCODE	OBJMODE	RPT	CYC
BF 16bitOffset,COND	0101 0110 1100 COND CCCC CCCC CCCC CCCC	1	-	4/4

**Operands**    **16bit-Offset**    16-bit signed immediate constant offset value (-32768 to +32767 range)  
**COND**            Conditional codes:

COND	Syntax	Description	Flags Tested
0000	NEQ	Not Equal To	Z = 0
0001	EQ	Equal To	Z = 1
0010	GT	Greater Than	Z = 0 AND N = 0
0011	GEQ	Greater Than Or Equal To	N = 0
0100	LT	Less Than	N = 1
0101	LEQ	Less Than Or Equal To	Z = 1 OR N = 1
0110	HI	Higher	C = 1 AND Z = 0
0111	HIS, C	Higher Or Same, Carry Set	C = 1
1000	LO, NC	Lower, Carry Clear	C = 0
1001	LOS	Lower Or Same	C = 0 OR Z = 1
1010	NOV	No Overflow	V = 0
1011	OV	Overflow	V = 1
1100	NTC	Test Bit Not Set	TC = 0
1101	TC	Test Bit Set	TC = 1
1110	NBIO	BIO Input Equal To Zero	BIO = 0
1111	UNC	Unconditional	-

**Description**            Fast conditional branch. If the specified condition is true, then branch by adding the signed 16-bit constant value to the current PC value; otherwise continue execution without branching:

If (COND = true) PC = PC + signed 16-bit offset;  
If (COND = false) PC = PC + 2;

**Note:** The branch fast (BF) instruction takes advantage of dual prefetch queue on the C28x core that reduces the cycles for a taken branch from 7 to 4:

If (COND = true) then the instruction takes 4 cycles.  
If (COND = false) then the instruction takes 4 cycles.

**Flags and Modes**        **V**            If the V flag is tested by the condition, then V is cleared.

**Modes**

**Repeat**                This instruction is not repeatable. If this instruction follows the RPT instruction, it resets the repeat counter (RPTC) and executes only once.

**C27MAP**

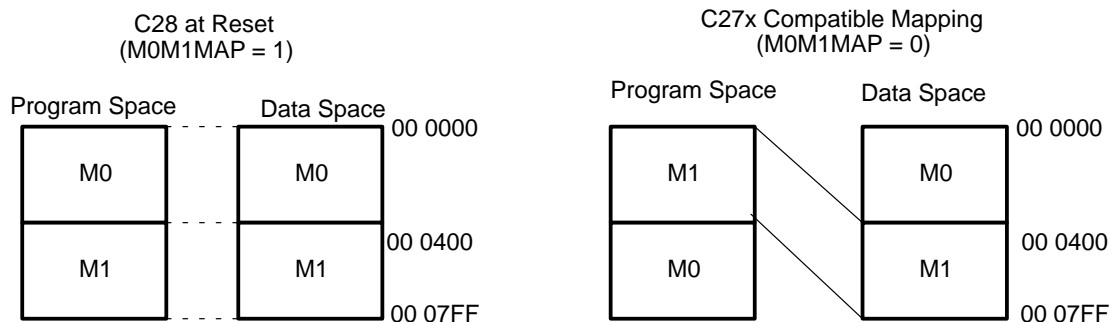
Set the M0M1MAP Bit

SYNTAX OPTIONS	OPCODE	OBJMODE	RPT	CYC
C27MAP	0101 0110 0011 1111	X	-	5

**Note:** This instruction is an alias for the "CLRC M0M1MAP" operation.

**Operands** None

**Description** Clear the M0M1MAP status bit, configuring the mapping of the M0 and M1 memory blocks for C27x object-compatible operation. The memory blocks are mapped as follows:



**Note:** The pipeline is flushed when this instruction is executed.

**Flags and M0M1MAP** The M0M1MAP bit is cleared.

**Modes**

**Repeat** This instruction is not repeatable. If this instruction follows the RPT instruction, it resets the repeat counter (RPTC) and executes only once.

**Example** ; Set the device mode from reset to C27x object-compatible mode:

```
Reset:
C27OBJ          ; Enable C27x Object Mode
C28ADDR        ; Enable C27x/C28x Address Mode
.c28_amode     ; Tell assembler we are using C27x/C28x addressing
C27MAP         ; Enable C27x Mapping Of M0 and M1 blocks
.
.
```

**C27OBJ***Clear the OBJMODE Bit*

SYNTAX OPTIONS	OPCODE	OBJMODE	RPT	CYC
C27OBJ	0101 0110 0011 0110	X	-	5

**Note:** This instruction is an alias for the “CLRC OBJMODE” operation.

**Operands**                None

**Description**            Clear the OBJMODE status bit in Status Register ST1, configuring the device to execute C27x object code. This is the default mode of the processor after reset.

**Note:** The pipeline is flushed when this instruction is executed.

**Flags and**                Clear the OBJMODE bit.

**Modes**

**Repeat**                 This instruction is not repeatable. If this instruction follows the RPT instruction, it resets the repeat counter (RPTC) and executes only once.

**Example**                ; Set the device mode from reset to C27x:  
Reset:  
C27OBJ                    ; Enable C27x Object Mode  
C28ADDR                 ; Enable C27x/C28x Address Mode  
.c28\_amode              ; Tell assembler we are in C27x/C28x addr mode  
C27MAP                  ; Enable C27x Mapping Of M0 and M1 blocks  
.  
.

**C28ADDR***Clear the AMODE Status Bit*

SYNTAX OPTIONS	OPCODE	OBJMODE	RPT	CYC
C28ADDR	0101 0110 0001 0110	X	-	1

**Note:** This instruction is an alias for the "CLRC AMODE" operation.

**Operands**               None

**Description**           Clear the AMODE status bit in Status Register ST1, putting the device in C27x/C28x addressing mode (see Chapter 5).

**Note:** This instruction does not flush the pipeline.

**Flags and Modes**       **AMODE** The AMODE bit is cleared.

**Repeat**                 This instruction is not repeatable. If this instruction follows the RPT instruction, it resets the repeat counter (RPTC) and executes only once.

**Example**               ; Execute the operation "VarC = VarA + VarB" written in  
; C2xLP syntax:

```

LPADDR                   ; Full C2xLP address compatible mode
.lp_amode               ; Tell assembler we are in C2xLP mode
LDP #VarA               ; Initialize DP (low 64K only)
LACL VarA               ; ACC = VarA (ACC high = 0)
ADDS VarB               ; ACC = ACC + VarB (unsigned)
SACL VarC               ; Store result into VarC
C28ADDR                 ; Return to C28x address mode
.c28_amode              ; Tell assembler we are in C28x mode

```

**C28MAP**

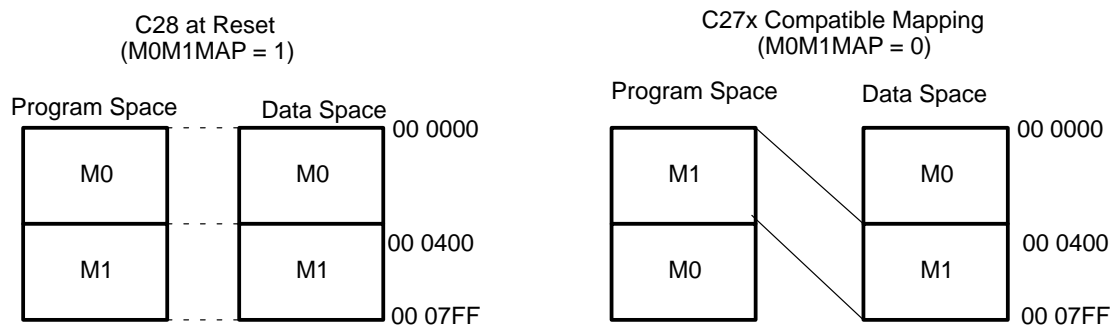
Set the M0M1MAP Bit

SYNTAX OPTIONS	OPCODE	OBJMODE	RPT	CYC
C28MAP	0101 0110 0001 1010	X	-	5

**Note:** This instruction is an alias for the "SETC M0M1MAP" instruction.

**Operands**                      None

**Description**                      Set the M0M1MAP status bit in Status register ST1, configuring the mapping of the M0 and M1 memory blocks for C28x operation. The memory blocks are mapped as follows:



**Note:** The pipeline is flushed when this instruction is executed.

**Flags and Modes**      **M0M1MAP** The M0M1MAP bit is set.

**Repeat**                      This instruction is not repeatable. If this instruction follows the RPT instruction, it resets the repeat counter (RPTC) and executes only once.

**Example**                      ; Set the device mode from reset to C28x mode:  
Reset:  
C28OBJ                      ; Enable C28x Object Mode  
C28ADDR                    ; Enable C28x Address Mode  
.c28\_amode                 ; Tell assembler we are in C28x address mode  
C28MAP                     ; Enable C28x Mapping Of M0 and M1 blocks  
.  
.

**C28OBJ***Set the OBJMODE Bit*

SYNTAX OPTIONS	OPCODE	OBJMODE	RPT	CYC
C28OBJ	0101 0110 0001 1111	X	-	5

**Note:** This instruction is an alias for the "SETC OBJMODE" instruction.

**Operands**                    None

**Description**                Set the OBJMODE status bit, putting the device in C28x object mode (supports C2xLP source):

**Flags and Modes**    **OBJMODE** Set the OBJMODE bit.

**Repeat**                    This instruction is not repeatable. If this instruction follows the RPT instruction, it resets the repeat counter (RPTC) and executes only once.

**Example**                ; Set the device mode from reset to C28x:  
Reset:  
C28OBJ                    ; Enable C28x Object Mode  
C28ADDR                 ; Enable C27x/C28x Address Mode  
.c28\_amode              ; Tell assembler we are in C27x/C28x address mode  
C28MAP                  ; Enable C28x Mapping Of M0 and M1 blocks  
.  
.

**CLRC AMODE***Clear the AMODE Bit*

SYNTAX OPTIONS	OPCODE	OBJMODE	RPT	CYC
CLRC AMODE	0101 0110 0001 0110	X	-	1

**Operands**    **AMODE**    Status bit

**Description**                    Clear the AMODE status bit in Status Register ST1, enabling C27x/C28x addressing (see Chapter 5).

**Note:** This instruction does not flush the pipeline.

**Flags and Modes**    **AMODE**    The AMODE bit is cleared.

**Repeat**                            This instruction is not repeatable. If this instruction follows the RPT instruction, it resets the repeat counter (RPTC) and executes only once.

**Example**                    ; Execute the operation "VarC = VarA + VarB" written in C2xLP  
; syntax:

```

SETC AMODE                    ; Full C2xLP address-compatible mode
.lp_amode                    ; Tell assembler we are in C2xLP mode
LDP #VarA                    ; Initialize DP (low 64K only)
LACL VarA                    ; ACC = VarA (ACC high = 0)
ADDS VarB                    ; ACC = ACC + VarB (unsigned)
SACL VarC                    ; Store result into VarC
CLRC AMODE                    ; Return to C28x address mode
.c28_amode                    ; Tell assembler we are in C28x mode

```



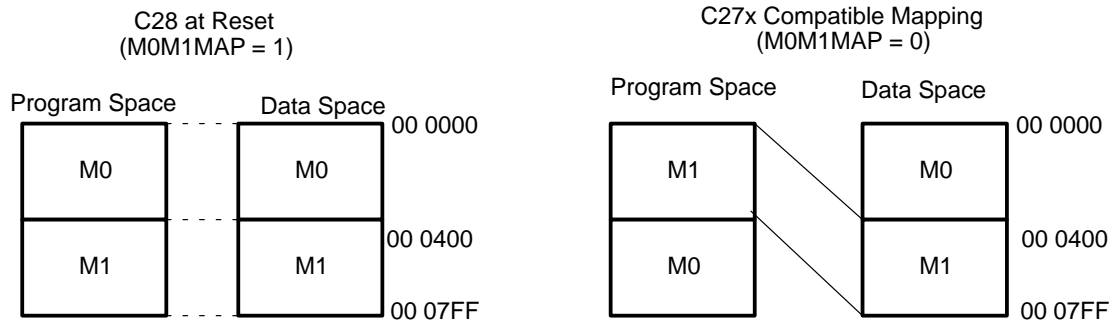
**CLRC M0M1MAP**

Clear the M0M1MAP Bit

SYNTAX OPTIONS	OPCODE	OBJMODE	RPT	CYC
CLRC M0M1MAP	0101 0110 0011 1111	X	-	5

**Operands**    **M0M1MAP**    Status bit

**Description**                    Clear the M0M1MAP status bit in Status Register ST1, configuring the mapping of the M0 and M1 memory blocks for C27x operation. The memory blocks are mapped as follows:



**Note:** The pipeline is flushed when this instruction is executed. This bit is provided for compatibility for users migrating from C27x. The M0M1MAP bit should always remain set to 1 for users operating in C28x mode and C2xLP source-compatible mode.

**Flags and**    **M0M1MAP**    The M0M1MAP bit is cleared.

**Modes**

**Example**                    ; Set the device mode from reset to C27x object-compatible mode:

```
Reset:
  CLRC OBJMODE      ; Enable C27x Object Mode
  CLRC AMODE        ; Enable C27x/C28x Address Mode
  .c28_амode        ; Tell assembler we are in C27x/C28x addr mode
  CLRC M0M1MAP     ; Enable C27x Mapping Of M0 and M1 blocks
  .
  .
```

**CLRC OBJMODE***Clear the OBJMODE Bit*

SYNTAX OPTIONS	OPCODE	OBJMODE	RPT	CYC
CLRC OBJMODE	0101 0110 0011 0110	X	-	5

**Operands**    **OBJMODE**    Status bit

**Description**                      Clear the OBJMODE status bit, enabling the device to execute C27x object code.

**Note:** The pipeline is flushed when this instruction is executed.

**Flags and Modes**    **OBJMODE**    The OBJMODE bit is cleared.

**Repeat**                              This instruction is not repeatable. If this instruction follows the RPT instruction, it resets the repeat counter (RPTC) and executes only once.

**Example**                            ; Set the device mode from reset to C27x object-compatible mode:  
Reset:  
    CLRC OBJMODE            ; Enable C27x Object Mode  
    CLRC AMODE              ; Enable C27x/C28x Address Mode  
    .c28\_amode              ; Tell assembler we are in C27x/C28x addr mode  
    CLRC MOM1MAP          ; Enable C27x Mapping Of M0 and M1 blocks  
    .  
    .

**CLRC OVC***Clear Overflow Counter*

SYNTAX OPTIONS	OPCODE	OBJMODE	RPT	CYC
CLRC OVC	0101 0110 0101 1100	1	-	1

**Note:** This instruction is an alias for the "ZAP OVC" operation.

**Operands**    **OVC**    Overflow counter bits in Status Register 0 (ST0)

**Description**            Clear the overflow counter (OVC) bits in ST0.

**Flags and**    **OVC**    The 6-bit overflow counter bits (OVC) are cleared.

**Modes**

**Repeat**                    This instruction is not repeatable. If this instruction follows the RPT instruction, it resets the repeat counter (RPTC) and executes only once.

**Example**

```

; Calculate: VarD = sat(VarA + VarB + VarC)
CLRC OVC                ; Zero overflow counter
MOVL ACC,@VarA          ; ACC = VarA
ADDL ACC,@VarB          ; ACC = ACC + VarB
ADDL ACC,@VarC          ; ACC = ACC + VarC
SAT ACC                 ; Saturate if OVC != 0
MOVL @VarD,ACC          ; Store saturated result into VarD

```

**CLRC XF***Clear XF Status Bit*

SYNTAX OPTIONS	OPCODE	OBJMODE	RPT	CYC
CLRC XF	0101 0110 0001 1011	X	-	1

**Operands**    **XF**        XF status bit and output signal

**Description**                Clear the XF status bit and pull the corresponding output signal low.

**Flags and**    **XF**        The XF status bit is cleared.

**Modes**

**Repeat**                        This instruction is not repeatable. If this instruction follows the RPT instruction, it resets the repeat counter (RPTC) and executes only once.

**Example**        ; Pulse XF signal high if branch not taken:  
                   MOV AL,@VarA                ; Load AL with contents of VarA  
                   SB Dest,NEQ                ; ACC = VarA  
                   SETC XF                    ; Set XF bit and signal high  
                   CLRC XF                    ; Clear XF bit and signal low  
                   .  
                   .  
                   Dest:  
                   .

**CLRC Mode**

Clear Status Bits

SYNTAX OPTIONS		OPCODE	OBJMODE	RPT	CYC
CLRC	mode	0010 1001 CCCC CCCC	X	–	1, 2
CLRC	SXM	0010 1001 0000 0001	X	–	1
CLRC	OVM	0010 1001 0000 0010	X	–	1
CLRC	TC	0010 1001 0000 0100	X	–	1
CLRC	C	0010 1001 0000 1000	X	–	1
CLRC	INTM	0010 1001 0001 0000	X	–	2
CLRC	DBGM	0010 1001 0010 0000	X	–	2
CLRC	PAGE0	0010 1001 0100 0000	X	–	1
CLRC	VMAP	0010 1001 1000 0000	X	–	1

**Description** Clear the specified status bits. The mode operand is a mask value that relates to the status bits in this way:

Mode bit	Status Register	Flag	Cycles
0	ST0	SXM	1
1	ST0	OVM	1
2	ST0	TC	1
3	ST0	C	1
4	ST1	INTM	2
5	ST1	DBGM	2
6	ST1	PAGE0	1
7	ST1	VMAP	1

**Note:** The assembler accepts any number of flag names in any order.

**Flags and Modes** **SXM** Any of the specified bits can be cleared by the instruction.  
**OVM**  
**TC**  
**C**  
**INTM**  
**DBGM**  
**PAGE0**  
**VMAP**

**Repeat** This instruction is not repeatable. If this instruction follows the RPT instruction, it resets the repeat counter (RPTC) and executes only once.

**Example**     ; Modify flag settings:

```
SETC  INTM,DBGM           ; Set INTM and DBGM bits to 1
CLRC  TC,C,SXM,OVM       ; Clear TC, C, SXM, OVM bits to 0
CLRC  #0xFF              ; Clear all bits to 0
SETC  #0xFF              ; Set all bits to 1
SETC  C,SXM,TC,OVM       ; Set TC, C, SXM, OVM bits to 1
CLRC  DBGM,INTM          ; Clear INTM and DBGM bits to 0
```

**CMP AX, loc16***Compare*

SYNTAX OPTIONS	OPCODE	OBJMODE	RPT	CYC
CMP AX, loc16	0101 010A LLLL LLLL	X	-	1

**Operands**    **AX**        Accumulator high (AH) or accumulator low (AL) register  
                   **loc16**        Addressing mode (see Chapter 5)

**Description**            The content of the specified AX register (AH or AL) is compared with the 16-bit content of the location pointed to by the "loc16" addressing mode. The result of (AX-- [loc16] ) is evaluated and the status flag bits set accordingly. The AX register and content of the location pointed to by "loc16" are left unchanged:

```
Set Flags On (AX - [loc16]);
```

**Flags and Modes**        **N**            If the result of the operation is negative, then N is set; otherwise it is cleared. The CMP instruction assumes infinite precision when it determines the sign of the result. For example, consider the subtraction 0x8000 - 0x0001. If the precision were limited to 16 bits, the result would cause an overflow to the positive number 0x7FFF and N would be cleared. However, because the CMP instruction assumes infinite precision, it would set N to indicate that 0x8000 - 0x0001 actually results in a negative number.

**Z**            The comparison is tested for a zero condition. The zero flag bit is set if the operation ( AX - [loc16] ) = 0, otherwise it is cleared.

**C**            If the subtraction generates a borrow, then C is cleared; otherwise C is set.

**Repeat**                This instruction is not repeatable. If this instruction follows the RPT instruction, it resets the repeat counter (RPTC) and executes only once.

**Example**                ; Branch if VarA is higher then VarB:  
MOV AL,@VarA                ; Load AL with contents of VarA  
CMPB AL,@VarB               ; Set Flags On (AL - VarB)  
SB Dest,HI                   ; Branch if VarA higher then VarB

**CMP loc16,#16bitSigned***Compare*

SYNTAX OPTIONS	OPCODE	OBJMODE	RPT	CYC
CMP loc16,#16bitSigned	0001 1011 LLLL LLLL CCCC CCCC CCCC CCCC	X	-	1

**Operands**    **loc16**            Addressing mode (see Chapter 5)  
                   **#16bitSigned**    16-bit immediate signed constant value

**Description**                            Compare the 16-bit contents of the location pointed to by the “loc16” addressing mode to the signed 16-bit immediate constant value. To perform the comparison, the result of ([loc16] – #16bitSigned ) is evaluated and the status flag bits are set accordingly. The content of “loc16” is left unchanged:

Modify flags on ([loc16] - 16bitSigned);

Smart Encoding:

If loc16 = AL or AH and #16bitSigned is an 8-bit number, then the assembler will encode this instruction as CMPB AX, #8bit, to override this encoding, use the CMPW AX, #16bitSigned instruction alias.

**Flags and Modes**    **N**                            If the result of the operation is negative, then N is set; otherwise it is cleared. The CMP instruction assumes infinite precision when it determines the sign of the result. For example, consider the subtraction 0x8000 – 0x0001. If the precision were limited to 16 bits, the result would cause an overflow to the positive number 0x7FFF and N would be cleared. However, because the CMP instruction assumes infinite precision, it would set N to indicate that 0x8000 – 0x0001 actually results in a negative number.

**Z**                            The comparison is tested for a zero condition. The zero flag bit is set if the operation ([loc16] – 16bitSigned ) = 0, otherwise it is cleared.

**C**                            If the subtraction generates a borrow, then C is cleared; otherwise C is set.

**Repeat**                            This instruction is not repeatable. If this instruction follows the RPT instruction, it resets the repeat counter (RPTC) and executes only once.

**Note:**                            The examples in this chapter assume that the device is already operating in C28x Mode (OBJMODE = 1, AMODE = 0). To put the device into C28x mode following a reset, you must first set the OBJMODE bit in ST1 by executing the “C28OBJ” (or “SETC OBJMODE”) instruction.



**Example**     ; Calculate:  
              ; if( VarA > 20 )  
              ;    VarA = 0;  
              CMP   @VarA,#20                 ; Set flags on (VarA - 20)  
              MOVB  @VarA,#0,GT             ; Zero VarA if greater then

**CMP64 ACC:P**

Compare 64-bit Value

SYNTAX OPTIONS	OPCODE	OBJMODE	RPT	CYC
CMP64 ACC:P	0101 0110 0101 1110	1	-	1

**Operands**    **ACC:P**    Accumulator register (ACC) and product register (P)

**Description**                    The 64-bit content of the combined ACC:P registers is compared against zero and the flags are set appropriately:

```

if((V = 1) & (ACC(bit 31) = 1))
    N = 0;
else
    N = 1;
if((V = 1) & (ACC(bit 31) = 0))
    N = 1;
else
    N = 0;
if(ACC:P = 0x8000 0000 0000 0000)
    Z = 1;
else
    Z = 0;
V = 0;

```

**Note:** This operation should be used as follows:

```

CMP64 ACC:P ; Clear V flag
perform 64-bit operation
CMP64 ACC:P ; Set Z,N flags, V=0
conditionally branch

```

**Flags and Modes**    **N**                    The content of the ACC register is tested to determine if the 64-bit ACC:P value is negative. The CMP64 instruction takes into account the state of the overflow flag (V) to increase precision when determining if ACC is negative. For example, consider the subtraction on ACC of 0x8000 0000 – 0x0000 0001. This results in an overflow to a positive number (0x7FFF FFFF) and V would be set. Because the CMP64 instruction takes into account the overflow, it would interpret the result as a negative number and not a positive number. If the value is ACC is found to be negative, then N is set; otherwise N is cleared.

**Z**                    The zero flag bit is set if the combined 64 bits of ACC:P is zero, otherwise it is cleared.

**V**                    The state of the V flag is used along with bit 31 of the ACC register to determine if the value in the ACC:P register is negative. V is cleared by the operation.

**Repeat**                    This instruction is not repeatable. If this instruction follows the RPT instruction, it resets the repeat counter (RPTC) and executes only once.

**Example** ; If 64-bit VarA > 64-bit VarB, branch:  
MOVL P,@VarA+0 ; Load P with low 32 bits of VarA  
MOVL ACC,@VarA+2 ; Load ACC with high 32 bits of VarA  
SUBUL P,@VarB+0 ; Sub from P unsigned low 32 bits of  
VarB  
CMP64 ACC:P ; Clear V flag  
SUBBL ACC,@VarB+2 ; Sub from ACC with borrow high 32 bits  
of VarB  
CMP64 ACC:P ; Set Z,N flags appropriately for ACC:P  
SB Dest,GT ; branch if VarA > VarB

**CMPB AX, #8bit**

Compare 8-bit Value

SYNTAX OPTIONS	OPCODE	OBJMODE	RPT	CYC
CMPB AX, #8bit	0101 001A CCCC CCCC	X	-	1

**Operands**    **AX**        Accumulator high (AH) or accumulator low (AL) register  
                   **#8bit**       8-bit immediate constant value

**Description**       Compare the content of the specified AX register (AH or AL) with the zero-extended 8-bit unsigned immediate constant. The result of (AX - 0:8bit) is evaluated and the status flag bits are set accordingly. The content of the AX register is left unchanged:

Set Flags On (AX - 0:8bit);

**Flags and Modes**    **N**        If the result of the operation is negative, then N is set; otherwise it is cleared. The CMPB instruction assumes infinite precision when it determines the sign of the result. For example, consider the subtraction 0x8000 - 0x0001. If the precision were limited to 16 bits, the result would cause an overflow to the positive number 0x7FFF and N would be cleared. However, because the CMPB instruction assumes infinite precision, it would set N to indicate that 0x8000 - 0x0001 actually results in a negative number.

**Z**        The comparison is tested for a zero condition. The zero flag bit is set if the operation (AX - [0:8bit]) = 0, otherwise it is cleared.

**C**        If the subtraction generates a borrow, then C is cleared; otherwise C is set.

**Repeat**                This instruction is not repeatable. If this instruction follows the RPT instruction, it resets the repeat counter (RPTC) and executes only once.

**Example**                ; Check if VarA is within range 0x80 <= VarA <= 0xF0:  
 MOV AL,@VarA                                ; Load AL with contents of VarA  
 CMPB AL,#0xF0                                ; Set Flags On (AL - 0x00F0)  
 SB OutOfRange,GT                             ; Branch if VarA greater then 0x00FF  
 CMPB AL,#0x80                                ; Set Flags On (AL - 0x0080)  
 SB OutOfRange,LT                             ; Branch if VarA less then 0x0080

**CMPL ACC,loc32**

*Compare 32-bit Value*

SYNTAX OPTIONS	OPCODE	OBJMODE	RPT	CYC
CMPL ACC,loc32	0000 1111 LLLL LLLL	X	-	1

**Operands**    **ACC**    Accumulator register  
                  **loc32**    Addressing mode (see Chapter 5)

**Description**                    The content of the ACC register is compared with the 32-bit location pointed to by the “loc32” addressing mode. The status flag bits are set according to the result of (ACC – [loc32]). The ACC register and the contents of the location pointed to by “loc32” are left unchanged:

Modify flags on (ACC – [loc32]);

**Flags and Modes**    **N**                    If the result of the operation is negative, then N is set; otherwise it is cleared. The CMPL instruction assumes infinite precision when it determines the sign of the result. For example, consider the subtraction 0x8000 0000 – 0x0000 0001. If the precision were limited to 32 bits, the result would cause an overflow to the positive number 0x7FFF FFFF and N would be cleared. However, because the CMPL instruction assumes infinite precision, it would set N to indicate that 0x8000 0000 – 0x0000 0001 actually results in a negative number.

**Z**                    The comparison is tested for a zero condition. The zero flag bit is set if the operation (AX – [loc32]) = 0, otherwise it is cleared.

**C**                    If the subtraction generates a borrow, C is cleared; otherwise C is set.

**Repeat**                    This instruction is not repeatable. If this instruction follows the RPT instruction, it resets the repeat counter (RPTC) and executes only once.

**Example**                    ; Swap the contents of 32-bit VarA and VarB if VarB is higher:  
 MOVL ACC,@VarB                    ; ACC = VarB  
 MOVL P,@VarA                    ; P = VarA  
 CMPL ACC,@P                    ; Set flags on (VarB - VarA)  
 MOVL @VarA,ACC,HI                    ; VarA = ACC if higher  
 MOVL @P,ACC,HI                    ; P = ACC if higher  
 MOVL @VarA,P                    ; VarA = P

**CMPL ACC,P << PM***Compare 32-bit Value*

SYNTAX OPTIONS	OPCODE	OBJMODE	RPT	CYC
CMPL ACC,P << PM	1111 1111 0101 1001	X	-	1

**Operands**

**ACC** Accumulator register

**P** Product register

**<<PM** Product shift mode

**Description**

The content of the ACC register is compared with the content of the P register, shifted by the amount specified by the product shift mode (PM). The status flag bits are set according to the result of (ACC - [P << PM]). The content of the ACC register and the P register are left unchanged:

Modify flags on (ACC - [P << PM]);

**Flags and Modes**

**N** If the result of the operation is negative, then N is set; otherwise it is cleared. The CMPL instruction assumes infinite precision when it determines the sign of the result. For example, consider the subtraction 0x8000 0000 - 0x0000 0001. If the precision were limited to 32 bits, the result would cause an overflow to the positive number 0x7FFF FFFF and N would be cleared. However, because the CMPL instruction assumes infinite precision, it would set N to indicate that 0x8000 0000 - 0x0000 0001 actually results in a negative number.

**Z** The comparison is tested for a zero condition. The zero flag bit is set if the operation (AX - [P<<PM]) = 0, otherwise, it is cleared.

**C** If the subtraction generates a borrow, C is cleared; otherwise C is set.

**PM** The value in the PM bits sets the shift mode for the output operation from the product register. If the product shift value is positive (logical left shift operation), then the low bits are zero filled. If the product shift value is negative (arithmetic right shift operation), the upper bits are sign extended.

**Repeat**

This instruction is not repeatable. If this instruction follows the RPT instruction, it resets the repeat counter (RPTC) and executes only once.

**Example**

```
; Compare the following (VarA - VarB >> 4):
MOVL ACC,@VarA           ; ACC = VarA
SPM  -4                   ; Set the product shift mode to ">> 4"
MOVL P,@VarB             ; P = VarB
CMPL ACC,P << PM         ; Compare (VarA - VarB >> 4)
```

**CMPR 0/1/2/3**

*Compare Auxiliary Registers*

SYNTAX OPTIONS	OPCODE	OBJMODE	RPT	CYC
CMPR 0	0101 0110 0001 1101	1	-	1
CMPR 1	0101 0110 0001 1001	1	-	1
CMPR 2	0101 0110 0001 1000	1	-	1
CMPR 3	0101 0110 0001 1100	1	-	1

**Operands**            None

**Description**            Compare AR0 to the 16-bit auxiliary register pointed to by ARP. The comparison type is determined by the instruction.

CMPR 0: if (AR0 = AR[ARP]) TC = 1, else TC = 0  
 CMPR 1: if (AR0 > AR[ARP]) TC = 1, else TC = 0  
 CMPR 2: if (AR0 < AR[ARP]) TC = 1, else TC = 0  
 CMPR 3: if (AR0 != AR[ARP]) TC = 1, else TC = 0

**Flags and Modes**    **ARP**    The 3-bit ARP points to the current valid Auxiliary Register, XAR0 to XAR7. This pointer determines which Auxiliary register is compared to AR0.

**TC**            If the test is true, TC is set, else TC is cleared.

**Repeat**            This instruction is not repeatable. If this instruction follows the RPT instruction, it resets the repeat counter (RPTC) and executes only once.

**Example**            TableA: .word 0x1111  
                       .word 0x2222  
 FuncA:  
     MOVL XAR1,#VarA                    ; Initialize XAR1 Pointer  
     MOVZ AR0,\*XAR1++                  ; Load AR0 with 0x1111, clear AR0H,  
     ; ARP = 1  
     MOVZ AR1,\*XAR1                    ; Load AR1 with 0x2222, clear AR1H  
     CMPR 0                              ; AR0 = AR1? No, clear TC  
     B    Equal,TC                      ; Don't branch  
     CMPR 2                              ; AR1 > AR2? Yes, set TC  
     B    Less,TC                       ; Branch to "Less"  
     .  
     .

**CSB ACC***Count Sign Bits*

SYNTAX OPTIONS	OPCODE	OBJMODE	RPT	CYC
CSB ACC	0101 0110 0011 0101	1	-	1

**Operands**    **ACC**    Accumulator register

**Description**            Count the sign bits in the ACC register by determining the number of leading 0s or 1s in the ACC register and storing the result, minus one, in the T register:

```
T = 0, 1 sign bit
T = 1, 2 sign bits
.
.
T = 31, 32 sign bits
```

**Note:** The count sign bit operation is often used in normalization operations and is particularly useful for algorithms such as; calculating Square Root of a number, calculating the inverse of a number, searching for the first "1" bit in a word.

**Flags and Modes**    **N**            N is set if bit 31 of ACC is 1, else N is cleared.

**Z**            Z is set if ACC is 0, else Z is cleared.

**TC**          The TC bit will reflect the state of the sign bit after the operation (TC=1 for negative).

**Repeat**                    This instruction is not repeatable. If this instruction follows the RPT instruction, it resets the repeat counter (RPTC) and executes only once.

**Example**                ; Normalize the contents of VarA:  
 MOVL    ACC,@VarA                    ; Load ACC with contents of VarA  
 CSB    ACC                            ; Count sign bits  
 LSL    ACC,T                         ; Logical shift left ACC by T(4:0)  
 MOVL    @VarA,ACC                   ; Store result into VarA



**DEC loc16***Decrement by 1*

SYNTAX OPTIONS	OPCODE	OBJMODE	RPT	CYC
DEC loc16	0000 1011 LLLL LLLL	X	-	1

**Operands**    **loc16**    Addressing mode (see Chapter 5)

**Description**                    Subtract 1 from the signed content of the location pointed to by the "loc16" addressing mode:

**Flags and Modes**

**N**            After the operation if bit 15 of [loc16] is 1, set N; otherwise, clear N.

**Z**            After the operation if [loc16] is zero, set Z; otherwise, clear Z.

**C**            If the subtraction generates a borrow, C is cleared; otherwise C is set.

**V**            If an overflow occurs, V is set; otherwise V is not affected.

**Repeat**                            This instruction is not repeatable. If this instruction follows the RPT instruction, it resets the repeat counter (RPTC) and executes only once.

**Example**

```

DEC    @VarA                            ; VarA = VarA - 1;
                                         ; Decrement contents of VarA

```

**DINT***Disable Maskable Interrupts (Set INTM Bit)*

SYNTAX OPTIONS	OPCODE	OBJMODE	RPT	CYC
DINT	0011 1011 0001 0000	X	-	2

**Note:** This instruction is an alias for the "SETC mode" operation with the "mode" field = INTM.

**Operands**                None

**Description**            Disable all maskable CPU interrupts by setting the INTM status bit. DINT has no effect on the unmaskable reset or NMI interrupts.

**Flags and Modes**        **INTM**    The instruction sets this bit to disable interrupts.

**Repeat**                    This instruction is not repeatable. If this instruction follows the RPT instruction, it resets the repeat counter (RPTC) and executes only once.

**Example**                ; Make the operation "VarC = VarA + VarB" atomic:

```

DINT                        ; Disable interrupts (INTM = 1)
MOVL  ACC,@VarA            ; ACC = VarA
ADDL  ACC,@VarB            ; ACC = ACC + VarB
MOVL  @VarC,ACC            ; Store result into VarC
EINT                        ; Enable interrupts (INTM = 0)

```

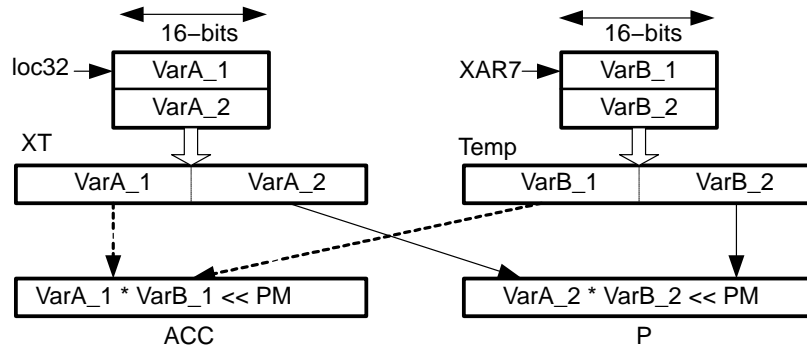
**DMAC ACC:P,loc32,\*XAR7/++**

*16-Bit Dual Multiply and Accumulate*

SYNTAX OPTIONS	OPCODE	OBJMODE	RPT	CYC
DMAC ACC:P,loc32,*XAR7	0101 0110 0100 1011 1100 0111 LLLL LLLL	1	Y	N+2
DMAC ACC:P,loc32,*XAR7++	0101 0110 0100 1011 1000 0111 LLLL LLLL	1	Y	N+2

**Operands**    **ACC:P**    Accumulator register (ACC) and product register (P)  
                   **loc32**     Addressing mode (see Chapter 5)  
                   **Note:**    The @ACC and @P register addressing modes cannot be used. No illegal instruction trap will be generated if used (assembler will flag an error).  
                   **\*XAR7 /++**   Indirect program-memory addressing using auxiliary register XAR7, can access full 4M x 16 program space range (0x000000 to 0x3FFFFFF)

**Description**                    Dual 16-bit x 16-bit signed multiply and accumulate. The first multiplication takes place between the upper words of the 32-bit locations pointed to by the “loc32” and \*XAR7/++ addressing modes and second multiplication takes place with the lower words.



After the operation the ACC contains the result of multiplying and adding the upper word of the addressed 32-bit operands. The P register contains the result of multiplying and adding the lower word of the addressed 32-bit operands.

```

XT      = [loc32];
Temp    = Prog[*XAR7 or *XAR7++];
ACC     = ACC + (XT.MSW * Temp.MSW) << PM;
P       = P   + (XT.LSW * Temp.LSW) << PM;
    
```

Z, N, V, C flags and OVC counter are affected by the operation on ACC only. The PM shift affects both the ACC and P operations.

On the C28x devices, memory blocks are mapped to both program and data space (unified memory), hence the `"*XAR7/++"` addressing mode can be used to access data space variables that fall within the program space address range.

With some addressing mode combinations, you can get conflicting references. In such cases, the C28x will give the `"loc16/loc32"` field priority on changes to XAR7.

For example:

```
DMAC ACC:P, *--XAR7, *XAR7++      ; --XAR7 given priority
DMAC ACC:P, *XAR7++, *XAR7        ; *XAR7++ given priority
DMAC ACC:P, *XAR7, *XAR7++        ; *XAR7++ given priority
```

**Flags and Modes**

- Z** After the addition, the Z flag is set if the ACC value is zero, else Z is cleared.
- N** After the addition, the N flag is set if bit 31 of the ACC is 1, else N is cleared.
- C** If the addition generates a carry of the ACC register, C is set; otherwise C is cleared.
- V** If an overflow of the ACC register occurs, V is set; otherwise V is not affected.
- OVC** If overflow mode is disabled; and if the operation generates a positive overflow of the ACC register, then the counter is incremented. If overflow mode is disabled; and if the operation generates a negative overflow of the ACC register, then the counter is decremented.
- OVM** If overflow mode bit is set; then the ACC value will saturate maximum positive (0x7FFFFFFF) or maximum negative (0x80000000) if the operation overflowed. Note that OVM only affects the ACC operation.
- PM** The value in the PM bits sets the shift mode for the output operation from the product register. The PM mode affects both the ACC and P register accumulates. If the product shift value is positive (logical left shift operation), then the low bits are zero filled. If the product shift value is negative (arithmetic right shift operation), the upper bits are sign extended.

**Repeat**

This instruction is repeatable. If the operation follows a RPT instruction, then it will be executed N+1 times. The state of the Z, N, C and OVC flags will reflect the final result in the ACC. The V flag will be set if an intermediate overflow occurs in the ACC.

```

Example      ; Calculate sum of product using dual 16-bit multiply:
                ; int16 X[N]          ; Data information
                ; int16 C[N]          ; Coefficient information (located in low 4M)
                ;                      ; Data and Coeff must be aligned to even address
                ;                      ; N must be an even number
                ; sum = 0;
                ; for(i=0; i < N; i++)
                ; sum = sum + (X[i] * C[i]) >> 5;
MOVL   XAR2,#X          ; XAR2 = pointer to X
MOVL   XAR7,#C          ; XAR7 = pointer to C
SPM    -5               ; Set product shift to ">> 5"
ZAPA   ; Zero ACC, P, OVC
RPT    #(N/2)-1        ; Repeat next instruction N/2 times
| |DMAC P,*XAR2++,*XAR7++ ; ACC = ACC + (X[i+1] * C[i+1]) >> 5
                ; P = P + (X[i] * C[i]) >> 5 i++
ADDL   ACC,@P          ; Perform final accumulate
MOVL   @sum,ACC        ; Store final result into sum

```

**DMOV loc16***Data Move Contents of 16-bit Location*

SYNTAX OPTIONS	OPCODE	OBJMODE	RPT	CYC
DMOV loc16	1010 0101 LLLL LLLL	1	Y	N+1

**Operands**    **loc16**    Addressing mode (see Chapter 5)

**Note:** For this operation, register-addressing modes cannot be used. The modes are: @ARn, @AH, @AL, @PH, @PL, @SP, @T. An illegal instruction trap will be generated.

**Description**                    Copy the contents pointed to by "loc16" into the next highest address:

[loc16 + 1] = [loc16];

**Flags and Modes**                    None

**Repeat**                            This instruction is repeatable. If the operation is follows a RPT instruction, then it will be executed N+1 times.

**Example**                    ; Calculate using 16-bit multiply:

```

; int16 X[3];
; int16 C[3];
; Y = (X[0]*C[0] >> 2) + (X[1]*C[1] >> 2) + (X[2]*C[2] >> 2);
; X[2] = X[1];
; X[1] = X[0];
SPM    -2                    ; Set product shift to >> 2
MOVDP   T,@X+2            ; T = X[2]
MPYS   P,T,@C+2           ; P = T*C[2], ACC = 0
MOVA   T,@X+1            ; T = X[1], ACC = X[2]*C[2] >> 2
MPY    P,T,@C+1           ; P = T*C[1]
MOVA   T,@X+0            ; T = X[0], ACC = ACC + X[1]*C[1] >> 2
MPY    P,T,@C+0           ; P = T*C[0]
ADDL   ACC,P << PM       ; ACC = ACC + X[0]*C[0] >> 2
DMOV   @X+1              ; X[2] = X[1]
DMOV   @X+0              ; X[1] = X[0]
MOVL   @Y,ACC            ; Store result into Y

```

**EALLOW***Enable Write Access to Protected Space*

SYNTAX OPTIONS	OPCODE	OBJMODE	RPT	CYC
EALLOW	0111 0110 0010 0010	X	-	4

**Operands**                      None

**Description**                      Enable access to emulation space and other protected registers.

This instruction sets the EALLOW bit in status register ST1. When this bit is set, the C28x CPU allows write access to the memory-mapped registers as well as other protected registers. See the data sheet for your particular device to determine which registers the EALLOW bit protects.

To again protect against writes to the registers, use the EDIS instruction.

EALLOW only controls write access; reads are allowed even if EALLOW has not been executed.

On an interrupt or trap, the current state of the EALLOW bit is saved off onto the stack within ST1 and the EALLOW bit is autocratically cleared. Therefore, at the start of an interrupt service routine access to the protected registers is disabled. The IRET instruction will restore the current state of the EALLOW bit saved on the stack.

The EALLOW bit is overridden via the JTAG port, allowing full control of register accesses during debug from Code Composer Studio.

**Flags and Modes**            **EALLOW**    The EALLOW flag is set.

**Repeat**                              This instruction is not repeatable. If this instruction follows the RPT instruction, it resets the repeat counter (RPTC) and executes only once.

**Example**                      ; Enable access to RegA and RegB which are EALLOW protected:

```

EALLOW                              ; Enable access to selected registers
AND @RegA,#0x4000                  ; RegA = RegA AND 0x0400
MOV @RegB,#0                        ; RegB = 0
EDIS                                   ; Disable access to selected registers

```

**EDIS***Disable Write Access to Protected Registers*

SYNTAX OPTIONS	OPCODE	OBJMODE	RPT	CYC
EDIS	0111 0110 0001 1010	X	-	4

**Operands**                   None

**Description**                   Disable access to emulation space and other protected registers.

This instruction clears the EALLOW bit in status register ST1. When this bit is clear, the C28x CPU does not allow write access to the memory-mapped emulation registers and other protected registers. See the data sheet for your particular device to determine which registers the EALLOW bit protects.

To allow write access to the registers, use the EALLOW instruction.

**Flags and Modes**   **EALLOW**   The EALLOW flag is cleared.

**Repeat**                   This instruction is not repeatable. If this instruction follows the RPT instruction, it resets the repeat counter (RPTC) and executes only once.

**Example**                   ; Enable access to RegA and RegB which are EALLOW protected:

```

EALLOW                   ; Enable access to selected registers
NOP                       ; Wait 2 cycles for enable to take
                          ; effect. The number of cycles is device
                          ; and/or register dependant.

NOP
AND   @RegA,#0x4000       ; RegA = RegA AND 0x0400
MOV   @RegB,#0           ; RegB = 0
EDIS                      ; Disable access to selected registers

```



**EINT***Enable Maskable Interrupts (Clear INTM Bit)*

SYNTAX OPTIONS	OPCODE	OBJMODE	RPT	CYC
EINT	0010 1001 0001 0000	X	-	2

**Note:** This instruction is an alias for the "CLRC mode" operation with the "mode" field = INTM.

**Operands**                None

**Description**            Enable interrupts by clearing the INTM status bit.

**Flags and Modes**        **INTM**    This bit is cleared by the instruction to enable interrupts.

**Repeat**                    This instruction is not repeatable. If this instruction follows the RPT instruction, it resets the repeat counter (RPTC) and executes only once.

**Example**                ; Make the operation "VarC = VarA + VarB" atomic:

```

DINT                        ; Disable interrupts (INTM = 1)
MOVL  ACC,@VarA            ; ACC = VarA
ADDL  ACC,@VarB            ; ACC = ACC + VarB
MOVL  @VarC,ACC            ; Store result into VarC
EINT                        ; Enable interrupts (INTM = 0)

```

**ESTOP0***Emulation Stop 0*

SYNTAX OPTIONS	OPCODE	OBJMODE	RPT	CYC
ESTOP0	0111 0110 0010 0101	X	-	1

**Operands**            None

**Description**        Emulation Stop 0

This instruction is available for emulation purposes. It is used to create a software breakpoint.

When an emulator is connected to the C28x and emulation is enabled, this instruction causes the C28x to halt, regardless of the state of the DBG M bit in status register ST1. In addition, ESTOP0 does not increment the PC.

When an emulator is not connected or when a debug program has disabled emulation, the ESTOP0 instruction is treated the same way as a NOP instruction. It simply advances the PC to the next instruction.

**Flags and Modes**        None

**Repeat**                This instruction is not repeatable. If this instruction follows the RPT instruction, it resets the repeat counter (RPTC) and executes only once.

**ESTOP1***Emulation Stop 1*

SYNTAX OPTIONS	OPCODE	OBJMODE	RPT	CYC
ESTOP1	0111 0110 0010 0100	X	-	1

**Operands**                None

**Description**            Emulation Stop 1

This instruction is available for emulation purposes. It is used to create an embedded software breakpoint.

When an emulator is connected to the C28x and emulation is enabled, this instruction causes the C28x to halt, regardless of the state of the DBG M bit in status register ST1. Before halting the processor, ESTOP1 increments the PC so that it points to the instruction following the ESTOP1.

When an emulator is not connected or when a debug program has disabled emulation, the ESTOP0 instruction is treated the same way as a NOP instruction. It simply advances the PC to the next instruction.

**Flags and Modes**                None

**Repeat**                        This instruction is not repeatable. If this instruction follows the RPT instruction, it resets the repeat counter (RPTC) and executes only once.

**FFC XAR7,22bit**

*Fast Function Call*

SYNTAX OPTIONS	OPCODE	OBJMODE	RPT	CYC
FFC XAR7,22bit	0000 0000 11CC CCCC CCCC CCCC CCCC CCCC	X	-	4

**Operands**    **XAR7**    Auxiliary register XAR7  
                  **22bit**    22-bit program-address (0x00 0000 to 0x3F FFFF range)

**Description**            Fast function call. The return PC value is stored into the XAR7 register and the 22-bit immediate destination address is loaded into the PC:

```
XAR7(21:0) = PC + 2;
XAR7(31:22) = 0;
PC = 22 bit;
```

**Flags and Modes**            None

**Repeat**                    This instruction is not repeatable. If this instruction follows the RPT instruction, it resets the repeat counter (RPTC) and executes only once.

**Example**                    ; Fast function call of FuncA:

```

FFC    XAR7,FuncA            ; Call FuncA, return address in XAR7
.
.

FuncA:                            ; Function A:
.
.
LB    *XAR7                    ; Return: branch to address in XAR7
```

**FLIP AX**

*Flip Order of Bits in AX Register*

SYNTAX OPTIONS	OPCODE	OBJMODE	RPT	CYC
FLIP AX	0101 0110 0111 000A	1	-	1

**Operands**    **AX**        Accumulator high (AH) or accumulator low (AL) register

**Description**            Bit reverse the contents of the specified AX register (AH or AL):

```
temp = AX;
AX(bit 0) = temp(bit 15);
AX(bit 1) = temp(bit 14);
.
.
AX(bit 14) = temp(bit 1);
AX(bit 15) = temp(bit 0);
```

**Flags and Modes**        **N**        After the operation, if bit 15 of AX is 1 then the negative flag bit is set; otherwise it is cleared.

**Z**        After the operation, if AX is 0, then the Z bit is set, otherwise it is cleared.

**Repeat**                    This instruction is not repeatable. If this instruction follows the RPT instruction, it resets the repeat counter (RPTC) and executes only once.

**Example**                ; Flip the contents of 32-bit variable VarA:

```
MOV    AH,@VarA+0                    ; Load AH with low 16 bits of VarA
MOV    AL,@VarA+1                    ; Load AL with high 16 bits of VarA
FLIP   AL                              ; Flip contents of AL
FLIP   AH                              ; Flip contents of AH
MOVL   @VarA,ACC                     ; Store 32-bit result in VarA
```

**IACK #16bit***Interrupt Acknowledge*

SYNTAX OPTIONS	OPCODE	OBJMODE	RPT	CYC
IACK #16bit	0111 0110 0011 1111 CCCC CCCC CCCC CCCC	X	-	1

**Operands**    **#16bit**    16-bit constant immediate value (0x0000 to 0xFFFF range)

**Description**                      Acknowledge an interrupt by outputting the specified 16-bit constant on the low 16 bits of the data bus. Certain peripherals will provide the capability to capture this value to provide low-cost trace. See the data sheet for details for your device.

```
data_bus(15:0) = 16bit;
```

**Flags and Modes**                      None

**Repeat**                                      This instruction is not repeatable. If this instruction follows the RPT instruction, it resets the repeat counter (RPTC) and executes only once.

SYNTAX OPTIONS	OPCODE	OBJMODE	RPT	CYC
IDLE	0111 0110 0010 0001	X	-	5

**Operands** None

**Description** Put the processor into idle mode and wait for enabled or nonmaskable interrupt. Devices using the 28x CPU may use the IDLE instruction in combination with external logic to achieve different low-power modes. See the device-specific datasheets for more detail. The idle instruction causes the following sequence of events:

- 1) The pipeline is flushed.
- 2) All outstanding memory cycles are completed.
- 3) The IDLESTAT bit of status register ST1 is set.
- 4) Clocks to the CPU are stopped after the entire instruction buffer is full, placing the device in the idle state. In the idle state, CLKOUT (the clock output from the CPU) and all clocks to blocks outside the CPU (including the emulation block) continue to operate as long as CLKIN (the clock input to the CPU) is driven. The PC continues to hold the address of the IDLE instruction; the PC is not incremented before the CPU enters the idle state.
- 5) The IDLE output CPU signal is activated (driven high).
- 6) The device waits for an enabled or nonmaskable hardware interrupt. If such an interrupt occurs, the IDLESTAT bit is cleared, the PC is incremented by 1, and the device exits the idle state.

If the interrupt is maskable, it must be enabled in the interrupt enable register (IER). However, the device exits the idle state regardless of the value of the interrupt global mask bit (INTM) of status register ST1.

After the device exits the idle mode, the CPU must respond to the interrupt request. If the interrupt can be disabled by the INTM bit in status register ST1, the next event depends on INTM:

- If (INTM = 0), then the interrupt is enabled, and the CPU executes the corresponding interrupt service routine. On return from the interrupt, execution begins at the instruction following the IDLE instruction.
- If (INTM = 1), then the interrupt is blocked and program execution continues at the instruction immediately following the IDLE.

If the interrupt cannot be disabled by INTM, the CPU executes the corresponding interrupt service routine. On return from the interrupt, execution begins at the instruction following the IDLE.

**Flags and Modes**     **IDLESTAT**     Before entering the idle mode, IDLESTAT is set; after exiting the idle mode IDLESTAT is cleared.

**Repeat**                             This instruction is not repeatable. If this instruction follows the RPT instruction, it resets the repeat counter (RPTC) and executes only once.



**IMACL P,loc32,\*XAR7/++**

*Signed 32 X 32-Bit Multiply and Accumulate (Lower Half)*

SYNTAX OPTIONS	OPCODE	OBJMODE	RPT	CYC
IMACL P,loc32,*XAR7	0101 0110 0100 1101 1100 0111 LLLL LLLL	1	Y	N+2
IMACL P,loc32,*XAR7/++	0101 0110 0100 1101 1000 0111 LLLL LLLL	1	Y	N+2

**Operands**    **P**            Product register

**loc32**        Addressing mode (see Chapter 5)

**Note:** The @ACC addressing mode cannot be used when the instruction is repeated. No illegal instruction trap will be generated if used (assembler will flag an error).

**\*XAR7/++**    Indirect program-memory addressing using auxiliary register XAR7; can access full 4Mx16 program space range (0x000000 to 0x3FFFFFF)

**Description**

32-bit x 32-bit signed multiply and accumulate. First, add the unsigned previous product (stored in the P register), ignoring the product shift mode (PM), to the ACC register. Then, multiply the signed 32-bit content of the location pointed to by the "loc32" addressing mode by the signed 32-bit content of the program-memory location pointed to by the XAR7 register. The product shift mode (PM) then determines which part of the lower 38 bits of the 64-bit result are stored in the P register. If specified, post-increment the XAR7 register by 1:

```
ACC = ACC + unsigned P;
temp(37:0) = lower_38 bits(signed [loc32]
                        * signed Prog[*XAR7 or XAR7/++]);
if( PM = +4 shift )
    P(31:4) = temp(27:0), P(3:0) = 0;
if( PM = +1 shift )
    P(31:1) = temp(30:0), P(0) = 0;
if( PM = 0 shift )
    P(31:0) = temp(31:0);
if( PM = -1 shift )
    P(31:0) = temp(32:1);
if( PM = -2 shift )
    P(31:0) = temp(33:2);
if( PM = -3 shift )
    P(31:0) = temp(34:3);
if( PM = -4 shift )
    P(31:0) = temp(35:4);
if( PM = -5 shift )
    P(31:0) = temp(36:5);
if( PM = -6 shift )
    P(31:0) = temp(37:6);
```

On the C28x devices, memory blocks are mapped to both program and data space (unified memory), hence the "*\*XAR7/++*" addressing mode can be used to access data space variables that fall within the program space address range. With some addressing mode combinations, you can get conflicting references. In such cases, the C28x will give the "loc16/loc32" field priority on changes to XAR7.

For example:

```
IMACL P, *--XAR7, *XAR7++ ; --XAR7 given priority
IMACL P, *XAR7++, *XAR7 ; *XAR7++ given priority
IMACL P, *XAR7, *XAR7++ ; *XAR7++ given priority
```

<b>Flags and Modes</b>	<b>Z</b>	After the addition, the Z flag is set if the ACC value is zero, else Z is cleared.
	<b>N</b>	After the addition, the N flag is set if bit 31 of the ACC is 1, else N is cleared.
	<b>C</b>	If the addition generates a carry, C is set; otherwise C is cleared.
	<b>V</b>	If an overflow occurs, V is set; otherwise V is not affected.
	<b>OVCU</b>	The overflow counter is incremented when the addition operation generates an unsigned carry. The OVM mode does not affect the OVCU counter.
	<b>PM</b>	The value in the PM bits sets the shift mode that determines which portion of the lower 38 bits of the 64-bit results are stored in the P register.

**Repeat** This instruction is repeatable. If the operation follows a RPT instruction, then it will be executed N+1 times. The state of the Z, N, C and OVC flags will reflect the final result in the ACC. The V flag will be set if an intermediate overflow occurs in the ACC.

```

Example      ; Calculate sum of product using 32-bit multiply and retain
                ; 64-bit result:
                ; int32 X[N]; // Data information
                ; int32 C[N]; // Coefficient information (located in
                // low 4M)
                ; int64 sum = 0;
                ; for(i=0; i < N; i++)
                ; sum = sum + (X[i] * C[i]) >> 5;
                ; Calculate low 32 bits:
                MOVL  XAR2,#X           ; XAR2 = pointer to X
                MOVL  XAR7,#C          ; XAR7 = pointer to C
                SPM   -5                ; Set product shift to ">> 5"
                ZAPA                ; Zero ACC, P, OVCU
                RPT   #(N-1)           ; Repeat next instruction N times
                | |IMACL P,*XAR2++,*XAR7++ ; OVCU:ACC = OVCU:ACC + P,
                ; P = (X[i] * C[i]) << 5,
                ; i++
                ADDUL ACC,@P           ; OVCU:ACC = OVCU:ACC + P
                MOVL  @sum+0,ACC       ; Store low 32 bits result into sum
                ; Calculate high 32 bits:
                MOVU  @AL,OVC          ; ACC = OVCU (carry count)
                MOVB  AH,#0
                MPYB  P,T,#0           ; P = 0
                MOVL  XAR2,#X          ; XAR2 = pointer to X
                MOVL  XAR7,#C          ; XAR7 = pointer to C
                RPT   #(N-1)           ; Repeat next instruction N times
                | |QMACL P,*XAR2++,*XAR7++ ; ACC = ACC + P >> 5,
                ; P = (X[i] * C[i]) >> 32,
                ; i++
                ADDL  ACC,P << PM     ; ACC = ACC + P >> 5
                MOVL  @sum+2,ACC       ; Store high 32 bits result into sum

```

**IMPYAL P,XT,loc32**

*Signed 32-Bit Multiply (Lower Half) and Add Previous P*

SYNTAX OPTIONS	OPCODE	OBJMODE	RPT	CYC
IMPYAL P,XT,loc32	0101 0110 0100 1100 0000 0000 LLLL LLLL	1	-	1

**Operands**

- P** Product register
- XT** Multiplicand register
- loc32** Addressing mode (see Chapter 5)

**Description** Add the unsigned content of the P register, ignoring the product shift mode (PM), to the ACC register. Multiply the signed 32-bit content of the XT register by the signed 32-bit content of the location pointed to by the "loc32" addressing mode. The product shift mode (PM) then determines which part of the lower 38 bits of the 64-bit result are stored in the P register:

```
ACC = ACC + unsigned P;
temp(37:0) = lower_38 bits(signed XT * signed [loc32]);
if( PM = +4 shift )
    P(31:4) = temp(27:0), P(3:0) = 0;
if( PM = +1 shift )
    P(31:1) = temp(30:0), P(0) = 0;
if( PM = 0 shift )
    P(31:0) = temp(31:0);
if( PM = -1 shift )
    P(31:0) = temp(32:1);
if( PM = -2 shift )
    P(31:0) = temp(33:2);
if( PM = -3 shift )
    P(31:0) = temp(34:3);
if( PM = -4 shift )
    P(31:0) = temp(35:4);
if( PM = -5 shift )
    P(31:0) = temp(36:5);
if( PM = -6 shift )
    P(31:0) = temp(37:6);
```

**Flags and Modes**

- Z** After the addition, the Z flag is set if the ACC value is zero, else Z is cleared.
- N** After the addition, the N flag is set if bit 31 of the ACC is 1, else N is cleared.
- C** If the addition generates a carry, C is set; otherwise C is cleared.
- V** If an overflow occurs, V is set; otherwise V is not affected.
- OVCU** The overflow counter is incremented when the addition operation generates an unsigned carry. The OVM mode does not affect the OVCU counter.
- PM** The value in the PM bits sets the shift mode that determines which portion of the lower 38 bits of the 64-bit results are stored in the P register.

**Repeat** This instruction is not repeatable. If this instruction follows the RPT instruction, it resets the repeat counter (RPTC) and executes only once.

**Example**

```

; Calculate signed result:
; Y64 = (X0*C0 + X1*C1 + X2*C2) >> 2
SPM    -2                ; Set product shift mode to ">> 2"
ZAPA                    ; Zero ACC, P, OVCU
MOVL   XT,@X0           ; XT = X0
IMPYAL P,XT,@C0        ; P = low 32 bits of (X0*C0 << 2)
MOVL   XT,@X1           ; XT = X1
IMPYAL P,XT,@C1        ; OVCU:ACC = OVCU:ACC + P,
                       ; P = low 32 bits of (X1*C1 << 2)

MOVL   XT,@X2           ; XT = X2
IMPYAL P,XT,@C2        ; OVCU:ACC = OVCU:ACC + P,
                       ; P = low 32 bits of (X2*C2 << 2)

ADDJUL ACC,@P          ; OVCU:ACC = OVCU:ACC + P
MOVL   @Y64+0,ACC      ; Store low 32-bit result into Y64
MOVU   @AL,OVC         ; ACC = OVCU (carry count)
MOVB   AH,#0
QMPYAL P,XT,@C2        ; P = high 32 bits of (X2*C2)
MOVL   XT,@X1           ; XT = X1
QMPYAL P,XT,@C1        ; ACC = ACC + P >> 2,
                       ; P = high 32 bits of (X1*C1)

MOVL   XT,@X0           ; XT = X0
QMPYAL P,XT,@C0        ; ACC = ACC + P >> 2,
                       ; P = high 32 bits of (X0*C0)

ADDL   ACC,P << PM     ; ACC = ACC + P >> 2
MOVL   @Y64+2,ACC      ; Store high 32-bit result into Y64

```

**IMPYL ACC,XT,loc32**

*Signed 32 X 32-Bit Multiply (Lower Half)*

SYNTAX OPTIONS	OPCODE	OBJMODE	RPT	CYC
IMPYL ACC,XT,loc32	0101 0110 0100 0100 0000 0000 LLLL LLLL	1	-	2

**Operands**

**ACC** Accumulator register

**XT** Multiplicand register

**loc32** Addressing mode (see Chapter 5)

**Description**

Multiply the signed 32-bit content of the XT register by the signed 32-bit content of the location pointed to by the "loc32" addressing mode and store the lower 32 bits of the 64-bit result in the ACC register:

$$ACC = \text{signed } XT * \text{signed } [loc32];$$

**Flags and Modes**

**Z** After the operation, the Z flag is set if the ACC value is zero, else Z is cleared.

**N** After the operation, the N flag is set if bit 31 of the ACC is 1, else N is cleared.

**Repeat**

This instruction is not repeatable. If this instruction follows the RPT instruction, it resets the repeat counter (RPTC) and executes only once.

**Example**

```

; Calculate result: Y32 = M32*X32 + B32
MOVL  XT,@M32           ; XT = M32
IMPYL ACC,XT,@X32       ; ACC = low 32 bits of (M32*X32)
ADDL  ACC,@B32          ; ACC = ACC + B32
MOVL  @Y32,ACC          ; Store result into Y32
    
```

**IMPYL P,XT,loc32**

*Signed 32 X 32-Bit Multiply (Lower Half)*

SYNTAX OPTIONS	OPCODE	OBJMODE	RPT	CYC
IMPYL P,XT,loc32	0101 0110 0000 0101 0000 0000 LLLL LLLL	1	-	1

**Operands**

- P** Product register
- XT** Multiplicand register
- loc32** Addressing mode (see Chapter 5)

**Description** Multiply the signed 32-bit content of the XT register by the signed 32-bit content of the location pointed to by the “loc32” addressing mode. The product shift mode (PM) then determines which part of the lower 38 bits of the 64-bit result gets stored in the P register as shown in the diagram below:

```
temp(37:0) = lower_38 bits(signed XT * signed [loc32]);
if( PM = +4 shift )
    P(31:4) = temp(27:0), P(3:0) = 0;
if( PM = +1 shift )
    P(31:1) = temp(30:0), P(0) = 0;
if( PM = 0 shift )
    P(31:0) = temp(31:0);
if( PM = -1 shift )
    P(31:0) = temp(32:1);
if( PM = -2 shift )
    P(31:0) = temp(33:2);
if( PM = -3 shift )
    P(31:0) = temp(34:3);
if( PM = -4 shift )
    P(31:0) = temp(35:4);
if( PM = -5 shift )
    P(31:0) = temp(36:5);
if( PM = -6 shift )
    P(31:0) = temp(37:6);
```

**Flags and Modes** **PM** The value in the PM bits sets the shift mode that determines which portion of the lower 38 bits of the 64-bit results are stored in the P register.

**Repeat** This instruction is not repeatable. If this instruction follows the RPT instruction, it resets the repeat counter (RPTC) and executes only once.

**Example**

```
; Calculate signed result: Y64 = M32*X32
MOVL  XT,@M32                ; XT = M32
IMPYL P,XT,@X32              ; P = low 32 bits of (M32*X32)
QMPYL ACC,XT,@X32           ; ACC = high 32 bits of (M32*X32)
MOVL  @Y64+0,P              ; Store result into Y64
MOVL  @Y64+2,ACC
```

**IMPYSL P,XT,loc32***Signed 32-Bit Multiply (Low Half) and Subtract P*

SYNTAX OPTIONS	OPCODE	OBJMODE	RPT	CYC
IMPYSL P,XT,loc32	0101 0110 0100 0011 0000 0000 LLLL LLLL	1	-	1

<b>Operands</b>	<b>P</b>	Product register
	<b>XT</b>	Multiplicand register
	<b>loc32</b>	Addressing mode (see Chapter 5)

**Description** Subtract the unsigned content of the P register, ignoring the product shift mode (PM), from the ACC register. Multiply the signed 32-bit content of the XT register by the signed 32-bit content of the location pointed to by the "loc32" addressing mode. The product shift mode (PM) then determines which part of the lower 38 bits of the 64-bit result are stored in the P register:

```
ACC = ACC - unsigned P;
temp(37:0) = lower_38 bits(signed XT * signed [loc32]);
if( PM = +4 shift )
    P(31:4) = temp(27:0), P(3:0) = 0;
if( PM = +1 shift )
    P(31:1) = temp(30:0), P(0) = 0;
if( PM = 0 shift )
    P(31:0) = temp(31:0);
if( PM = -1 shift )
    P(31:0) = temp(32:1);
if( PM = -2 shift )
    P(31:0) = temp(33:2);
if( PM = -3 shift )
    P(31:0) = temp(34:3);
if( PM = -4 shift )
    P(31:0) = temp(35:4);
if( PM = -5 shift )
    P(31:0) = temp(36:5);
if( PM = -6 shift )
    P(31:0) = temp(37:6);
```

<b>Flags and Modes</b>	<b>Z</b>	After the subtraction, the Z flag is set if the ACC value is zero, else Z is cleared.
	<b>N</b>	After the subtraction, the N flag is set if bit 31 of the ACC is 1, else N is cleared.
	<b>C</b>	If the subtraction generates a borrow, C is cleared; otherwise C is set.
	<b>V</b>	If an overflow occurs, V is set; otherwise V is not affected.
	<b>OVCU</b>	The overflow counter is decremented when the subtraction operation generates an unsigned borrow. The OVM mode does not affect the OVCU counter.



**PM** The value in the PM bits sets the shift mode that determines which portion of the lower 38 bits of the 64-bit results are stored in the P register.

**Repeat** This instruction is not repeatable. If this instruction follows the RPT instruction, it resets the repeat counter (RPTC) and executes only once.

**Example**

```

; Calculate signed result:
; Y64 = (-X0*C0 - X1*C1 - X2*C2) >> 2
SPM    -2                ; Set product shift mode to ">> 2"
ZAPA                    ; Zero ACC, P, OVCU
MOVL   XT,@X0           ; XT = X0
IMPYSL P,XT,@C0         ; P = low 32 bits of (X0*C0 << 2)
MOVL   XT,@X1           ; XT = X1
IMPYSL P,XT,@C1         ; OVCU:ACC = OVCU:ACC - P,
; P = low 32 bits of (X1*C1 << 2)

MOVL   XT,@X2           ; XT = X2
IMPYSL P,XT,@C2         ; OVCU:ACC = OVCU:ACC - P,
; P = low 32 bits of (X2*C2 << 2)

SUBUL  ACC,@P           ; OVCU:ACC = OVCU:ACC - P
MOVL   @Y64+0,ACC       ; Store low 32-bit result into Y64
MOVU   @AL,OVC          ; ACC = OVCU (borrow count)
MOVB   AH,#0
NEG    ACC               ; Negate borrow
QMPYSL P,XT,@C2         ; P = high 32 bits of (X2*C2)
MOVL   XT,@X1           ; XT = X1
QMPYSL P,XT,@C1         ; ACC = ACC - P >> 2, |
; P = high 32 bits of (X1*C1)

MOVL   XT,@X0           ; XT = X0
QMPYSL P,XT,@C0         ; ACC = ACC - P >> 2,
; P = high 32 bits of (X0*C0)

SUBL   ACC,P << PM      ; ACC = ACC - P >> 2
MOVL   @Y64+2,ACC       ; Store high 32-bit result into Y64

```

**IMPYXUL P,XT,loc32**

*Signed 32 X Unsigned 32-Bit Multiply (Lower Half)*

SYNTAX OPTIONS	OPCODE	OBJMODE	RPT	CYC
IMPYXUL P,XT,loc32	0101 0110 0110 0101 0000 0000 LLLL LLLL	1	-	1

**Operands**    **P**        Product register  
                  **XT**        Multiplicand register  
                  **loc32**     Addressing mode (see Chapter 5)

**Description**                    Multiply the signed 32-bit content of the XT register by the unsigned 32-bit content of the location pointed to by the "loc32" addressing mode. The product shift mode (PM) then determines which part of the lower 38 bits of the 64-bit result are stored in the P register:

```
temp(37:0) = lower_38 bits(signed XT * unsigned [loc32]);
if( PM = +4 shift )
    P(31:4) = temp(27:0), P(3:0) = 0;
if( PM = +1 shift )
    P(31:1) = temp(30:0), P(0) = 0;
if( PM = 0 shift )
    P(31:0) = temp(31:0);
if( PM = -1 shift )
    P(31:0) = temp(32:1);
if( PM = -2 shift )
    P(31:0) = temp(33:2);
if( PM = -3 shift )
    P(31:0) = temp(34:3);
if( PM = -4 shift )
    P(31:0) = temp(35:4);
if( PM = -5 shift )
    P(31:0) = temp(36:5);
if( PM = -6 shift )
    P(31:0) = temp(37:6);
```

**Flags and Modes**    **PM**            The value in the PM bits sets the shift mode that determines which portion of the lower 38 bits of the 64-bit results are stored in the P register.

**Repeat**                            This instruction is not repeatable. If this instruction follows the RPT instruction, it resets the repeat counter (RPTC) and executes only once.

**Example**

```
; Calculate result: Y64 = M64*X64 + B64
; Y64 = Y1:Y0, M64 = M1:M0, X64 = X1:X0, B64 = B1:B0
MOVL    XT,@X0          ; XT = X0
IMPYUL  P,XT,@M0       ; P = low 32 bits of (uns M0 * uns X0)
MOVL    ACC,@B0        ; ACC = B0
ADDUL   ACC,@P         ; ACC = ACC + P
MOVL    @Y0,ACC        ; Store result into Y0
QMPYUL  P,XT,@M0       ; P = high 32 bits of (uns M0 * uns X0)
MOVL    XT,@X1        ; XT = X1
MOVL    ACC,@P         ; ACC = P
IMPYXUL P,XT,@M0       ; P = low 32 bits of (uns M0 * sign X1)
MOVL    XT,@M1        ; XT = M1
ADDCL   ACC,@P         ; ACC = ACC + P + carry
IMPYXUL P,XT,@X0       ; P = low 32 bits of (sign M1 * uns X0)
ADDUL   ACC,@P         ; ACC = ACC + P
ADDUL   ACC,@B1        ; ACC = ACC + B1
MOVL    @Y1,P          ; Store result into Y1
```

**IN loc16,\*(PA)***Input Data From Port*

SYNTAX OPTIONS	OPCODE	OBJMODE	RPT	CYC
IN loc16,*(PA)	1011 0100 LLLL LLLL CCCC CCCC CCCC CCCC	1	Y	N+2

<b>Operands</b>	<b>loc16</b>	Addressing mode (see Chapter 5)
	<b>*(PA)</b>	Immediate I/O space memory address
<b>Description</b>		<p>Load the location pointed to by the "loc16" addressing mode with the content of the specified I/O location pointed to by "(PA)":</p> <p>[loc16] = Iospace[PA];</p> <p>I/O Space is limited to 64K range (0x0000 to 0xFFFF). On the external interface (XINTF), the I/O strobe signal (<math>\overline{XIS}</math>), if available on your particular device, is toggled during the operation. The I/O address appears on the lower 16 XINTF address lines (XA[15:0]) and the upper address lines are zeroed. The data is read on the lower 16 data lines (XD[15:0]).</p> <p><b>Note:</b> I/O space may not be implemented on all C28x devices. See the data sheet for your particular device for details.</p>
<b>Flags and Modes</b>	<b>N</b>	If (loc16 = @AX), then after the move AX is tested for a negative condition. The negative flag bit is set if bit 15 of AX is 1, otherwise it is cleared.
	<b>Z</b>	If (loc16 = @AX), then after the move, AX is tested for a zero condition. The zero flag bit is set if AX = 0, otherwise it is cleared.
<b>Repeat</b>		This instruction is repeatable. If the operation follows a RPT instruction, then it will be executed N+1 times. When repeated, the "(PA)" I/O space address is post-incremented by 1 during each repetition.
<b>Example</b>		<pre> ; IOREgA address = 0x0300; ; IOREgB address = 0x0301; ; IOREgC address = 0x0302; ; IOREgA = 0x0000; ; IOREgB = 0x0400; ; IOREgC = VarA; ; if( IOREgC = 0x2000 ) ;   IOREgC = 0x0000; IORegA .set 0x0300      ; Define IOREgA address IORegB .set 0x0301      ; Define IOREgB address IORegC .set 0x0302      ; Define IOREgC address MOV    @AL,#0           ; AL = 0 UOUT   *(IORegA),@AL    ; Iospace[IORegA] = AL MOV    @AL,#0x0400      ; AL = 0x0400 UOUT   *(IORegB),@AL    ; Iospace[IORegB] = AL OUT    *(IORegC),@VarA  ; Iospace[IORegC] = VarA IN     @AL,* (IORegC)   ; AL = Iospace[IORegC] CMP    @AL,#0x2000      ; Set flags on (AL - 0x2000) SB     \$10,NEQ          ; Branch if not equal </pre>

*IN loc16,\**(PA)**

---

```
MOV    @AL,#0           ; AL = 0
UOUT   *(IORegC),@AL    ; IOspace[IORegC] = AL
$10:
```

**INC loc16***Increment by 1*

SYNTAX OPTIONS	OPCODE	OBJMODE	RPT	CYC
INC loc16	0000 1010 LLLL LLLL	X	-	1

**Operands**    **loc16**    Addressing mode (see Chapter 5)

**Description**                    Add 1 to the signed content of the location pointed to by the “loc16” addressing mode:

[loc16] = [loc16] + 1;

**Flags and Modes**

- N**                    After the operation if bit 15 of [loc16] 1, set N; otherwise, clear N.
- Z**                    After the operation if [loc16] is zero, set Z; otherwise, clear Z.
- C**                    If the addition generates a carry, C is set; otherwise C is cleared.
- V**                    If an overflow occurs, V is set; otherwise V is not affected.

**Repeat**                    This instruction is not repeatable. If this instruction follows the RPT instruction, it resets the repeat counter (RPTC) and executes only once.

**Example**

```
; VarA = VarA + 1;
INC    @VarA                                    ; Increment contents of VarA
```

**INTR***Emulate Hardware Interrupt*

SYNTAX OPTIONS	OPCODE	OBJMODE	RPT	CYC
INTR INTx	0000 0000 0001 CCCC	X	–	8
INTR DLOGINT	0000 0000 0001 CCCC	X	–	8
INTR RTOSINT	0000 0000 0001 CCCC	X	–	8
INTR NMI	0111 0110 0001 0110	X	–	8
INTR EMUINT	0111 0110 0001 1100	X	–	8

<b>Operands</b>	<b>INTx</b>	Maskable CPU interrupt vector name, x = 1 to 14
	<b>DLOGINT</b>	Maskable CPU datalogging interrupt
	<b>RTOSINT</b>	Maskable CPU real-time operating system interrupt
	<b>NMI</b>	Nonmaskable interrupt
	<b>EMUINT</b>	Maskable emulation interrupt

**Description** Emulate an interrupt. The INTR instruction transfers program control to the interrupt service routine that corresponds to the vector specified by the instruction. The INTR instruction is not affected by the INTM bit in status register ST1. It is also not affected by enable bits in the interrupt enable register (IER) or the debug interrupt enable register (DBGIER). Once the INTR instruction reaches the decode 2 phase of the pipeline, hardware interrupts cannot be serviced until the INTR instruction is finished executing (until the interrupt service routine begins).

INTx	Interrupt	INTx	Interrupt
where x =	Vector	where x =	Vector
0	RESET	9	INT9
1	INT1	10	INT10
2	INT2	11	INT11
3	INT3	12	INT12
4	INT4	13	INT13
5	INT5	14	INT14
6	INT6		
7	INT7		
8	INT8		

Part of the operation involves saving pairs of 16-bit CPU registers onto the stack pointed to by the SP register. Each pair of registers is saved in a single 32-bit operation. The register forming the low word of the pair is saved first (to an even address); the register forming the high word of the pair is saved next (to the following odd address). For example, the first value saved is the concatenation of the T register and the status register ST0 (T:ST0). ST0 is saved first, then T.

This instruction should not be used with vectors 1–12 when the peripheral interrupt expansion (PIE) block is enabled.

```

if(not the NMI vector)
Clear the corresponding IFR bit;
Flush the pipeline;
temp = PC + 1;
Fetch specified vector;
SP = SP + 1;
[SP] = T:ST0;
SP = SP + 2;
[SP] = AH:AL;
SP = SP + 2;
[SP] = PH:PL;
SP = SP + 2;
[SP] = AR1:AR0;
SP = SP + 2;
[SP] = DP:ST1;
SP = SP + 2;
[SP] = DBGSTAT:IER;
SP = SP + 2;
[SP] = temp;
Clear corresponding IER bit;
INTM = 0;      // disable INT1–INT14, DLOGINT, RTOSINT
DBGM = 1;      // disable debug events
EALLOW = 0;    // disable access to emulation registers
LOOP = 0;      // clear loop flag
IDLESTAT = 0; //clear idle flag
PC = fetched vector;

```

<b>Flags and Modes</b>	<b>DBGM</b>	Debug events are disabled by setting the DBGM bit.
	<b>INTM</b>	Setting the INTM bit disables maskable interrupts.
	<b>EALLOW</b>	EALLOW is cleared to disable access to protected registers.
	<b>LOOP</b>	The loop flag is cleared.
	<b>IDLESTAT</b>	The idle flag is cleared.

**Repeat** This instruction is not repeatable. If this instruction follows the RPT instruction, it resets the repeat counter (RPTC) and executes only once.



SYNTAX OPTIONS	OPCODE	OBJMODE	RPT	CYC
IRET	0111 0110 0000 0010	X	-	8

**Operands** None

**Description** Return from an interrupt. The IRET instruction restores the PC value and other register values that were automatically saved by an interrupt operation. The order in which the values are restored is opposite to the order in which they were saved. All values are popped from the stack using 32-bit operations. The stack pointer is not forced to align to an even address during the register restore operations:

```

SP = SP - 2;
PC = [SP];
SP = SP - 2;

DBGSTAT:IER = [SP];
SP = SP - 2;
DP:ST1 = [SP];

SP = SP - 2;
AR1:AR0 = [SP];

SP = SP - 2;
PH:PL = [SP];
SP = SP - 2;
AH:AL = [SP];
SP = SP - 2;
T:ST0 = [SP];
SP = SP - 1;

```

**Note:** Interrupts cannot be serviced until the IRET instruction completes execution.

**Flags and Modes**

<b>SXM</b>	The operation restores the state of all flags and modes of the ST0 register.
<b>OVM</b>	
<b>TC</b>	
<b>C</b>	
<b>Z</b>	
<b>N</b>	
<b>V</b>	
<b>PM</b>	
<b>OVC</b>	
<b>INTM</b>	The operation restores the state of the specified flags and modes of the ST1 register. The following bits are not affected: LOOP, IDLESTAT, M0M1MAP

**DBGM  
PAGEO  
VMAP  
SPA  
EAL-  
LOW  
AMODE  
OBJ-  
MODE  
XF  
ARP**

**Repeat**

This instruction is not repeatable. If this instruction follows the RPT instruction, it resets the repeat counter (RPTC) and executes only once.

**Example** ; Full interrupt context Save and Restore:  
; Vector table:  
INTx: .long INTxService ; INTx interrupt vector  
.  
.  
.  
; Interrupt context save:  
INTxService: ; ACC, P, T, ST0, ST1, DP, AR0,  
; AR1, IER, DPGSTAT registers saved  
; on stack.  
; Return PC saved on stack.  
; IER bit corresponding to INTx  
; is disabled.  
; ST1(EALLOW bit = 0).  
; ST1(LOOP bit = 0).  
; ST1(DBGM bit = 1).  
; ST1(INTM bit = 1).  
  
PUSH AR1H:AR0H ; Save remaining registers.  
PUSH XAR2  
PUSH XAR3  
PUSH XAR4  
PUSH XAR5  
PUSH XAR6  
PUSH XAR7  
PUSH XT  
; Interrupt user code:  
.  
.  
.  
; Interrupt context restore:  
POP XT ; Restore registers.  
POP XAR7  
POP XAR6  
POP XAR5  
POP XAR4  
POP XAR3  
POP XAR2  
POP AR1H:AR0H  
IRET ; Return from interrupt.

**LB \*XAR7***Long Indirect Branch*

SYNTAX OPTIONS	OPCODE	OBJMODE	RPT	CYC
LB *XAR7	0111 0110 0010 0000	X	-	4

**Operands** \*XAR7 indirect program-memory addressing using auxiliary register XAR7, can access full 4Mx16 program space range (0x000000 to 0x3FFFFFF)

**Description** Long branch indirect. Load the PC with the lower 22 bits of the XAR7 register:  
PC = XAR7(21:0);

**Flags and Modes** None

**Repeat** This instruction is not repeatable. If this instruction follows the RPT instruction, it resets the repeat counter (RPTC) and executes only once.

**Example** ; Branch to subroutines in SwitchTable selected by Switch value:

```
SwitchTable:                ; Switch address table:
    .long    Switch0        ; Switch0 address
    .long    Switch1        ; Switch1 address
    .
    .

    MOVL     XAR2,#SwitchTable ; XAR2 = pointer to SwitchTable
    MOVZ     AR0,@Switch      ; AR0 = Switch index
    MOVL     XAR7,*+XAR2[AR0] ; XAR7 = SwitchTable[Switch]
    LB       *XAR7           ; Indirect branch using XAR7
SwitchReturn:
    .
    .

Switch0:                    ; Function A:
    .
    .
    LB       SwitchReturn    ; Return: long branch

Switch1:                    ; Function B:
    .
    .
    LB       SwitchReturn    ; Return: long branch
```

**LB 22bit**

*Long Branch*

SYNTAX OPTIONS	OPCODE	OBJMODE	RPT	CYC
LB 22bit	0000 0000 01CC CCCC CCCC CCCC CCCC CCCC	X	-	4

**Operands**    **22bit**    22-bit program-address (0x000000 to 0x3FFFFFF range)

**Description**            Long branch. Load the PC with the selected 22-bit program address:  
PC = 22bit;

**Flags and Modes**            None

**Repeat**                    This instruction is not repeatable. If this instruction follows the RPT instruction, it resets the repeat counter (RPTC) and executes only once.

```

Example            ; Branch to subroutines in SwitchTable selected by Switch
                     ; value:
SwitchTable:                             ; Switch address table:
                     .long    Switch0                             ; Switch0 address
                     .long    Switch1                             ; Switch1 address
                     .
                     .
                     MOVL    XAR2,#SwitchTable            ; XAR2 = pointer to SwitchTable
                     MOVZ    ARO,@Switch                 ; ARO = Switch index
                     MOVL    XAR7,*+XAR2[ARO]            ; XAR7 = SwitchTable[Switch]
                     LB      *XAR7                         ; Indirect branch using XAR7
SwitchReturn:
                     .
                     .
Switch0:                                 ; Function A:
                     .
                     .
                     LB      SwitchReturn                 ; Return: long branch
Switch1:                                 ; Function B:
                     .
                     .
                     LB      SwitchReturn                 ; Return: long branch
    
```

## LC \*XAR7

## Long Indirect Call

SYNTAX OPTIONS	OPCODE	OBJMODE	RPT	CYC
LC *XAR7	0111 0110 0000 0100	X	-	4

**Operands** \*XAR7 indirect program-memory addressing using auxiliary register XAR7, can access full 4Mx16 program space range (0x000000 to 0x3FFFFFF)

**Description** Indirect long call. The return PC value is pushed onto the software stack, pointed to by SP register, in two 16-bit operations. Next, the destination address stored in the XAR7 register is loaded into the PC:

```
temp(21:0) = PC + 1;
[SP] = temp(15:0);
SP = SP + 1;
[SP] = temp(21:16);
SP = SP + 1;
PC = XAR7(21:0);
```

**Note:** For more efficient function calls when operating with OBJMODE = 1, use the LCR and LRETR instructions instead of the LC and LRET instructions.

**Flags and Modes** None

**Repeat** This instruction is not repeatable. If this instruction follows the RPT instruction, it resets the repeat counter (RPTC) and executes only once.

**Example** ; Call to subroutines in SwitchTable selected by Switch value:

```
SwitchTable: ; Switch address table:
    .long    Switch0 ; Switch0 address
    .long    Switch1 ; Switch1 address
    .
    .
    MOVL    XAR2,#SwitchTable ; XAR2 = pointer to SwitchTable
    MOVZ    AR0,@Switch ; AR0 = Switch index
    MOVL    XAR7,*+XAR2[AR0] ; XAR7 = SwitchTable[Switch]
    LC      *XAR7 ; Indirect call using XAR7
    .
    .
Switch0: ; Subroutine 0:
    .
    .
    LRET ; Return
Switch1: ; Subroutine 1:
    .
    .
    LRET ; Return
```

**LC 22bit**

*Long Call*

SYNTAX OPTIONS	OPCODE	OBJMODE	RPT	CYC
LC 22bit	0000 0000 10CC CCCC CCCC CCCC CCCC CCCC	X	-	4

**Operands**    **22bit**    22-bit program-address (0x00 0000 to 0x3F FFFF range)

**Description**            Long function call. The return PC value is pushed onto the software stack, pointed to by SP register, in two 16-bit operations. Next, the immediate 22-bit destination address is loaded onto the PC:

```
temp(21:0) = PC + 2;
[SP] = temp(15:0);
SP = SP + 1;
[SP] = temp(21:16);
SP = SP + 1;
PC = 22bit;
```

**Note:** For more efficient function calls when operating with OBJMODE = 1, use the LCR and LRETR instructions instead of the LC and LRET instructions.

**Flags and Modes**            None

**Repeat**                      This instruction is not repeatable. If this instruction follows the RPT instruction, it resets the repeat counter (RPTC) and executes only once.

**Example**

```
; Standard function call of FuncA:
LC FuncA                      ; Call FuncA, return address on stack
.
.

FuncA:                         ; Function A:
.
.
LRET                           ; Return from address on stack
```

**LCR #22bit**

*Long Call Using RPC*

SYNTAX OPTIONS	OPCODE	OBJMODE	RPT	CYC
LCR #22bit	0111 0110 01CC CCCC CCCC CCCC CCCC CCCC	1	-	4

**Operands**    **22bit**    22-bit program-address (0x00 0000 to 0x3F FFFF range)

**Description**            Long call using return PC pointer (RPC). The current RPC value is pushed onto the software stack, pointed to by SP register, in two 16-bit operations. Next, the RPC register is loaded with the return address. Next, the 22-bit immediate destination address is loaded into the PC:

```
[SP] = RPC(15:0);
SP = SP + 1;
[SP] = RPC(21:16);
SP = SP + 1;
RPC = PC + 2;
PC = 22bit;
```

**Note:** The LCR and LRETR operations, enable 4 cycle call and 4 cycle return. The standard LC and LRET operations only enable a 4 cycle call and 8 cycle return. The LCR and LRETR operations can be nested and can freely replace the LC and LRET operations. This is the case on interrupts also. Only on a task switch operation, does the RPC need to be manually saved and restored.

**Flags and Modes**            None

**Repeat**                    This instruction is not repeatable. If this instruction follows the RPT instruction, it resets the repeat counter (RPTC) and executes only once.

```
Example            ; RPC call of FuncA:
                  LCR    FuncA                    ; Call FuncA, return address in RPC
                  .
                  .
                  FuncA:                            ; Function A:
                  .
                  .
                  LRETR                            ; RPC return
```



**LCR \*XARn***Long Indirect Call Using RPC*

SYNTAX OPTIONS	OPCODE	OBJMODE	RPT	CYC
LCR *XARn	0011 1110 0110 0RRR	1	-	4

**Operands** \*XARn indirect program-memory addressing using auxiliary register XAR0 to XAR7, can access full 4Mx16 program space range (0x000000 to 0x3FFFFFF)

**Description** Long indirect call using return PC pointer (RPC). The current RPC value is pushed onto the software stack, pointed to by SP register, in two 16-bit operations. Next, the RPC register is loaded with the return address. Next, the destination address stored in the XARn register is loaded into the PC:

```
[SP] = RPC(15:0);
SP = SP + 1;
[SP] = RPC(21:16);
SP = SP + 1;
RPC = PC + 1;
PC = XARn(21:0);
```

**Note:** The LCR and LRETR operations, enable 4 cycle call and 4 cycle return. The standard LC and LRET operations only enable a 4 cycle call and 8 cycle return. The LCR and LRETR operations can be nested and can freely replace the LC and LRET operations. This is the case on interrupts also. Only on a task switch operation, does the RPC need to be manually saved and restored.

**Flags and Modes** None

**Repeat** This instruction is not repeatable. If this instruction follows the RPT instruction, it resets the repeat counter (RPTC) and executes only once.

**Example** ; Call to subroutines in SwitchTable selected by Switch value:

```
SwitchTable:                ; Switch address table:
    .long Switch0           ; Switch0 address
    .long Switch1           ; Switch1 address
    .
    MOVL XAR2,#SwitchTable  ; XAR2 = pointer to SwitchTable
    MOVZ AR0,@Switch        ; AR0 = Switch index
    MOVL XAR6,*+XAR2[AR0]   ; XAR6 = SwitchTable[Switch]
    LCR *XAR6                ; Indirect RPC call using XAR6
    .
Switch0:                    ; Subroutine 0:
    .
    .
    LRETR                    ; RPC Return
Switch1:                    ; Subroutine 1:
    .
    LRETR                    ; RPC Return
```

**LOOPNZ loc16,#16bit***Loop While Not Zero*

SYNTAX OPTIONS	OPCODE	OBJMODE	RPT	CYC
LOOPNZ loc16,#16bit	0010 1110 LLLL LLLL CCCC CCCC CCCC CCCC	X	-	5N+5

**Operands**    **loc16**    Addressing mode (see Chapter 5)  
                   **#16bit**    16-bit immediate value (0x0000 to 0xFFFF range)

**Description**                    Loop while not zero.

```
while([loc16] & 16bit != 0);
```

The LOOPNZ instruction uses a bitwise AND operation to compare the value referenced by the "loc16" addressing mode and the 16-bit mask value. The instruction performs this comparison repeatedly for as long as the result of the operation is not 0. The process can be described as follows:

- 1) Set the LOOP bit in status register ST1.
- 2) Generate the address for the value referenced by the "loc16" addressing mode.
- 3) If "loc16" is an indirect-addressing operand, perform any specialized modification to the SP or the specified auxiliary register and/or the ARPN pointer.
- 4) Compare the addressed value with the mask value by using a bitwise AND operation.
- 5) If the result is 0, clear the LOOP bit and increment the PC by 2. If the result is not 0, then return to step 1.

The loop created by steps 1 through 5 can be interrupted by hardware interrupts. When an interrupt occurs, if the LOOPNZ instruction is still active, the return address saved on the stack points to the LOOPNZ instruction. Therefore, upon return from the interrupt the LOOPNZ instruction is fetched again.

While the result of the AND operation is not 0, the LOOPNZ instruction begins again every five cycles in the decode 2 phase of the pipeline. Thus the memory location or register is read once every five cycles. If you use an indirect addressing mode for the "loc16" operand, you can specify an increment or decrement for the pointer (SP or auxiliary register). If you do, the pointer is modified each time in the decode 2 phase of the pipeline. This means that the mask value is compared with a new data-memory value each time.

The LOOPNZ instruction does not flush prefetched instructions from the pipeline. However, when an interrupt occurs, prefetched instructions are flushed.

When any interrupt occurs, the current state of the LOOP bit is saved as ST1 is saved on the stack. The LOOP bit in ST1 is then cleared by the interrupt. The LOOP bit is a passive status bit. The LOOPNZ instruction changes LOOP, but LOOP does not affect the instruction.

You can abort the LOOPNZ instruction within an interrupt service routine. Test the LOOP bit saved on the stack. If it is set, then increment (by 2) the return address on the stack. Upon return from the interrupt, this incremented address is loaded into the PC and the instruction following the LOOPNZ is executed.

**Flags and Modes**

- N** If bit 15 of the result of the AND operation is 1, set N; otherwise, clear N.
- Z** If the result of the AND operation is 0, set Z; otherwise, clear Z.
- LOOP** LOOP is repeatedly set while the result of the AND operation is not 0. LOOP is cleared when the result is 0. If an interrupt occurs before the LOOPNZ instruction enters the decode 2 phase of the pipeline, the instruction is flushed from the pipeline and, thus, does not affect the LOOP bit.

**Repeat**

This instruction is not repeatable. If this instruction follows the RPT instruction, it resets the repeat counter (RPTC) and executes only once.

**Example**

```

; Wait until bit 3 in RegA is cleared before writing to RegB:
LOOPNZ @RegA,#0x0004      ; Loop while (RegA AND 0x0004 != 0)
MOV     @RegB,#0x8000     ; RegB = 0x8000
    
```

**LOOPZ loc16,#16bit***Loop While Zero*

SYNTAX OPTIONS	OPCODE	OBJMODE	RPT	CYC
LOOPZ loc16,#16bit	0010 1100 LLLL LLLL CCCC CCCC CCCC CCCC	X	-	5N+5

**Operands**    **loc16**    Addressing mode (see Chapter 5)  
                   **#16bit**    16-bit immediate value (0x0000 to 0xFFFF range)

**Description**                    Loop while zero.

```
while([loc16] & 16bit = 0);
```

The LOOPZ instruction uses a bitwise AND operation to compare the value referenced by the "loc16" addressing mode and the 16-bit mask value. The instruction performs this comparison repeatedly for as long as the result of the operation is 0. The process can be described as follows:

- 1) Set the LOOP bit in status register ST1.
- 2) Generate the address for the value referenced by the "loc16" addressing mode.
- 3) If "loc16" is an indirect-addressing operand, perform any specialized modification to the SP or the specified auxiliary register and/or the ARPN pointer.
- 4) Compare the addressed value with the mask value by using a bitwise AND operation.
- 5) If the result is not 0, clear the LOOP bit and increment the PC by 2. If the result is 0, then return to step 1.

The loop created by steps 1 through 5 can be interrupted by hardware interrupts. When an interrupt occurs, if the LOOPZ instruction is still active, the return address saved on the stack points to the LOOPZ instruction. Therefore, upon return from the interrupt the LOOPZ instruction is fetched again.

While the result of the AND operation is 0, the LOOPZ instruction begins again every five cycles in the decode 2 phase of the pipeline. Thus the memory location or register is read once every five cycles. If you use an indirect addressing mode for the "loc16" operand, you can specify an increment or decrement for the pointer (SP or auxiliary register). If you do, the pointer is modified each time in the decode 2 phase of the pipeline. This means that the mask value is compared with a new data-memory value each time.

The LOOPZ instruction does not flush prefetched instructions from the pipeline. However, when an interrupt occurs, prefetched instructions are flushed.

When any interrupt occurs, the current state of the LOOP bit is saved as ST1 is saved on the stack. The LOOP bit in ST1 is then cleared by the interrupt. The LOOP bit is a passive status bit. The LOOPZ instruction changes LOOP, but LOOP does not affect the instruction.

You can abort the LOOPZ instruction within an interrupt service routine. Test the LOOP bit saved on the stack. If it is set, then increment (by 2) the return address on the stack. Upon return from the interrupt, this incremented address is loaded into the PC and the instruction following the LOOPZ is executed.

**Flags and Modes**

- N** If bit 15 of the result of the AND operation is 1, set N; otherwise, clear N.
- Z** If the result of the AND operation is 0, set Z; otherwise, clear Z.
- LOOP** LOOP is repeatedly set while the result of the AND operation is 0. LOOP is cleared when the result is not 0. If an interrupt occurs before the LOOPZ instruction enters the decode 2 phase of the pipeline, the instruction is flushed from the pipeline and, thus, does not affect the LOOP bit.

**Repeat**

This instruction is not repeatable. If this instruction follows the RPT instruction, it resets the repeat counter (RPTC) and executes only once.

**Example**

```

; Wait until bit 3 in RegA is set before writing to RegB:
LOOPZ @RegA,#0x0004      ; Loop while (RegA AND 0x0004 = 0)
MOV   @RegB,#0x8000     ; RegB = 0x8000
    
```

**LPADDR***Set the AMODE Bit*

SYNTAX OPTIONS	OPCODE	OBJMODE	RPT	CYC
LPADDR	0101 0110 0001 1110	X	-	1

**Note:** LPADDR is an alias for the SETC AMODE Operation.

**Operands**                None

**Description**            Set the AMODE status bit, putting the device in C2xLP compatible addressing mode (see Chapter 5).

**Note:** This instruction does not flush the pipeline.

**Flags and Modes**        **AMODE** The AMODE bit is set.

**Repeat**                    This instruction is not repeatable. If this instruction follows the RPT instruction, it resets the repeat counter (RPTC) and executes only once.

**Example**                ; Execute the operation "VarC = VarA + VarB" written in C2xLP syntax:

```

LPADDR                    ; Full C2xLP address compatible mode
.lp_amode                 ; Tell assembler we are in C2xLP mode
LDP    #VarA              ; Initialize DP (low 64K only)
LACL   VarA               ; ACC = VarA (ACC high = 0)
ADDS   VarB               ; ACC = ACC + VarB (unsigned)
SACL   VarC               ; Store result into VarC
C28ADDR                  ; Return to C28x address mode
.c28_amode                ; Tell assembler we are in C28x mode

```

## LRET

---

### LRET

*Long Return*

SYNTAX OPTIONS	OPCODE	OBJMODE	RPT	CYC
LRET	0111 0110 0001 0100	X	-	8

**Operands**            None

**Description**        Long return. The return address is popped, from the software stack into the PC, in two 16-bit operations:

```
SP = SP - 1;
temp(31:16) = [SP];
SP = SP - 1;
temp(15:0) = [SP];
PC = temp(21:0);
```

**Flags and Modes**    None

**Note:** For more efficient function calls when operating with OBJMODE = 1, use the LCR and LRETR instructions in place of the LC and LRET instructions.

**Repeat**             This instruction is not repeatable. If this instruction follows the RPT instruction, it resets the repeat counter (RPTC) and executes only once.

**Example**            ; Standard function call of FuncA:

```
LC FuncA                    ; Call FuncA, return address on stack
.
.

FuncA:                      ; Function A:
.
.
LRET                        ; Return from address on stack
```

**LRETE***Long Return and Enable Interrupts*

SYNTAX OPTIONS	OPCODE	OBJMODE	RPT	CYC
LRETE	0111 0110 0001 0000	X	-	8

**Operands**            None

**Description**            Long return and enable interrupts. The return address is popped, from the software stack into the PC, in two 16-bit operations. Next, the global interrupt flag (INTM) is cleared. This enables global maskable interrupts:

```
SP = SP - 1;
temp(31:16) = [SP];
SP = SP - 1;
temp(15:0) = [SP];
PC = temp(21:0);
INTM = 0;
```

**Flags and Modes**    **INTM**    This instruction enables interrupts by clearing the INTM bit.

**Repeat**                This instruction is not repeatable. If this instruction follows the RPT instruction, it resets the repeat counter (RPTC) and executes only once.

**Example**

```
; Standard function call of FuncA. Disable interrupts on entry and
; enable interrupts on exit:
LC   FuncA           ; Call FuncA, return address on stack
.
.

FuncA:
SETC INTM           ; Disable interrupts
.
.
LRETE              ; Return from address on stack,
                  ; Enable interrupts
```



**LRETR***Long Return Using RPC*

SYNTAX OPTIONS	OPCODE	OBJMODE	RPT	CYC
LRETR	0000 0000 0000 0110	1	-	4

**Operands**                None

**Description**            Long return using return PC pointer (RPC). The return address stored in the RPC register is loaded onto the PC. Next, the RPC register is loaded from the software stack in two 16-bit operations:

```
PC = RPC;
SP = SP - 1;
temp(31:16) = [SP];
SP = SP - 1;
temp(15:0) = [SP];
RPC = temp(21:0);
```

**Note:** The LCR and LRETR operations, enable 4 cycle call and 4 cycle return. The standard LC and LRET operations only enable a 4 cycle call and 8 cycle return. The LCR and LRETR operations can be nested and can freely replace the LC and LRET operations. This is the case on interrupts also. Only on a task switch operation, does the RPC need to be manually saved and restored.

**Flags and Modes**        None

**Repeat**                    This instruction is not repeatable. If this instruction follows the RPT instruction, it resets the repeat counter (RPTC) and executes only once.

**Example**                ; RPC call of FuncA:

```

    LCR    FuncA           ; Call FuncA, return address in RPC
    .
    .

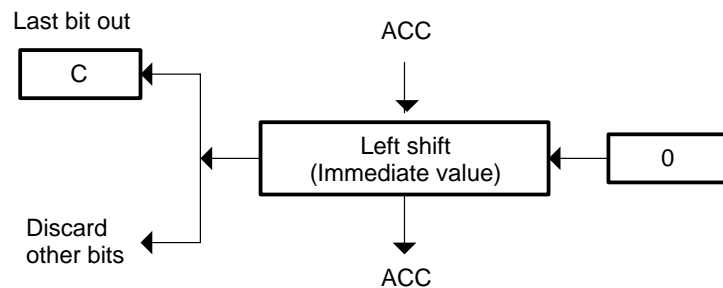
FuncA:
    .
    .
    LRETR                   ; RPC return
```

**LSL ACC,#1..16***Logical Shift Left*

SYNTAX OPTIONS	OPCODE	OBJMODE	RPT	CYC
LSL ACC,#1..16	1111 1111 0011 SHFT	X	Y	N+1

**Operands**    **ACC**     Accumulator register  
                   **#1..16**    Shift value

**Description**            Perform a logical shift left on the content of the ACC register by the amount specified by the shift value. During the shift, the low order bits of the ACC register are zero filled and the last bit shifted out is stored in the carry flag bit:



**Flags and Modes**    **N**     After the shift, if bit 31 of ACC is 1 then the negative flag bit is set; otherwise it is cleared.

**Z**     After the shift, if ACC is 0, then the Z bit is set, otherwise it is cleared.

**C**     The last bit to be shifted out of ACC is stored in C.

**Repeat**                This instruction is repeatable. If the operation follows a RPT instruction, then the LSL instruction will be executed N+1 times. The state of the Z, N, and C flags will reflect the final result.

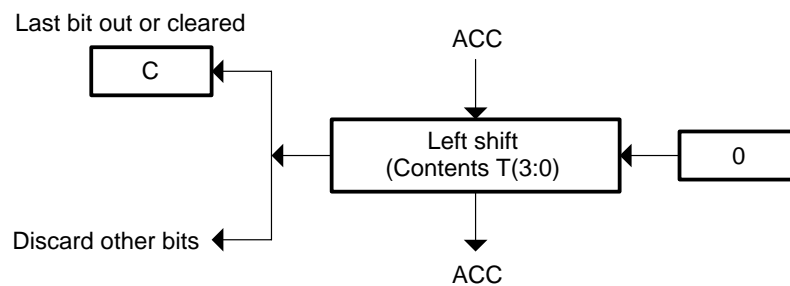
**Example**            ; Logical shift left contents of VarA by 4:  
                   MOVL    ACC,@VarA                ; ACC = VarA  
                   LSL     ACC,#4                ; Logical shift left ACC by 4  
                   MOVL    @VarA,ACC            ; Store result into VarA

**LSL ACC,T***Logical Shift Left by T(3:0)*

SYNTAX OPTIONS	OPCODE	OBJMODE	RPT	CYC
LSL ACC,T	1111 1111 0101 0000	X	-	1

**Operands**    **ACC**    Accumulator register  
                   **T**        Upper 16 bits of the multiplicand (XT) register

**Description**        Perform a logical shift left on the content of the ACC register by the amount specified by the four least significant bits of the T register,  $T(3:0) = 0 \dots 15$ . Higher order bits are ignored. During the shift, the low order bits of the ACC register are zero filled. If T specifies a shift of 0, then C is cleared; otherwise, C is filled with the last bit to be shifted out of the ACC register:



**Flags and Modes**    **Z**        After the shift, the Z flag is set if the ACC value is zero, else Z is cleared. Even if the T register specifies a shift of 0, the content of the ACC register is still tested for the zero condition and Z is affected.

**N**        After the shift, the N flag is set if bit 31 of the ACC is 1, else N is cleared. Even if the T register specifies a shift of 0, the content of the ACC register is still tested for the negative condition and N is affected.

**C**        If  $(T(3:0) = 0)$  then C is cleared; otherwise, the last bit shifted out is loaded into the C flag bit.

**Repeat**                This instruction is not repeatable. If this instruction follows the RPT instruction, it resets the repeat counter (RPTC) and executes only once.

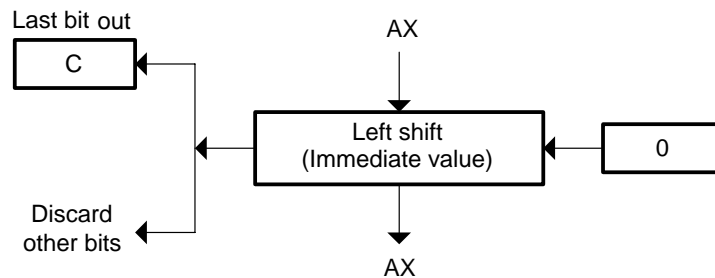
**Example**                ; Logical shift left contents of VarA by VarB:  
                   MOVL    ACC,@VarA                ; ACC = VarA  
                   MOV     T,@VarB                ; T = VarB (shift value)  
                   LSL     ACC,T                ; Logical shift left ACC by T(3:0)  
                   MOVL    @VarA,ACC            ; Store result into VarA

**LSL AX,#1...16***Logical Shift Left*

SYNTAX OPTIONS	OPCODE	OBJMODE	RPT	CYC
LSL AX,#1...16	1111 1111 100A SHFT	X	-	1

**Operands**    **AX**        Accumulator high (AH) or accumulator low (AL) register  
                   **#1...16**    Shift value

**Description**        Perform a logical shift left on the content of the specified AX register (AH or AL) by the amount given "shift value" field. During the shift, the low order bits of the AX register are zero filled and the last bit to be shifted out is stored in the carry bit flag:



**Flags and Modes**

**N**        After the shift, if bit 15 of AX is 1 then the negative flag bit is set; otherwise it is cleared.

**Z**        After the shift, if AX is 0, then the Z bit is set, otherwise it is cleared.

**C**        The last bit to be shifted out of AH or AL is stored in C.

**Repeat**            This instruction is not repeatable. If this instruction follows the RPT instruction, it resets the repeat counter (RPTC) and executes only once.

**Example**            ; Multiply index register AR0 by 2:  
 MOV    AL,@AR0                            ; Load AL with contents of AR0  
 LSL    AL,#1                                ; Scale result by 1 (\*2)  
 MOV    @AR0,AL                             ; Store result back in AR0

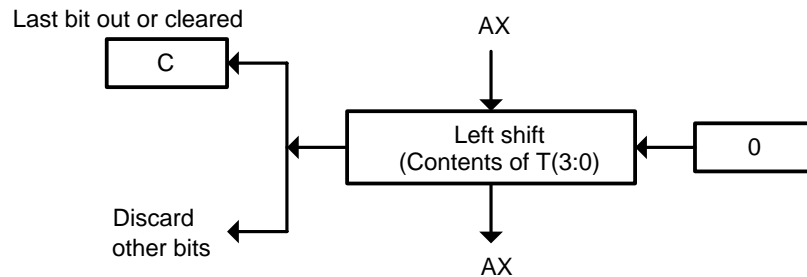
**LSL AX,T**

*Logical Shift Left by T(3:0)*

SYNTAX OPTIONS	OPCODE	OBJMODE	RPT	CYC
LSL AX,T	1111 1111 0110 011A	X	-	1

**Operands**    **AX**    Accumulator high (AH) or accumulator low (AL) register  
                   **T**        Upper 16 bits of the multiplicand (XT) register

**Description**            Perform a logical shift left on the content of the specified AX register by the amount specified by the four least significant bits of the T register, T(3:0). The contents of higher order bits are ignored. During the shift, the low order bits of the AX register are zero filled. If the T(3:0) register bits specify a shift of 0, then C is cleared; otherwise, C is filled with the last bit to be shifted out of AX:



**Flags and Modes**    **N**    After the shift, if bit 15 of AX is 1 then the negative flag bit is set; otherwise it is cleared. Even if the T(3:0) register bits specify a shift of 0, the value of AH or AL is still tested for the negative condition and N is affected.

**Z**    After the shift, if AX is 0, then the Z bit is set, otherwise it is cleared. Even if the T(3:0) register bits specify a shift of 0, the value of AH or AL is still tested for the zero condition and Z is affected.

**C**    If T(3:0) specifies a shift of 0, then C is cleared; otherwise, C is filled with the last bit to be shifted out of AH or AL.

**Repeat**                    This instruction is not repeatable. If this instruction follows the RPT instruction, it resets the repeat counter (RPTC) and executes only once.

**Example**                ; Calculate value: VarC = VarA << VarB;

```

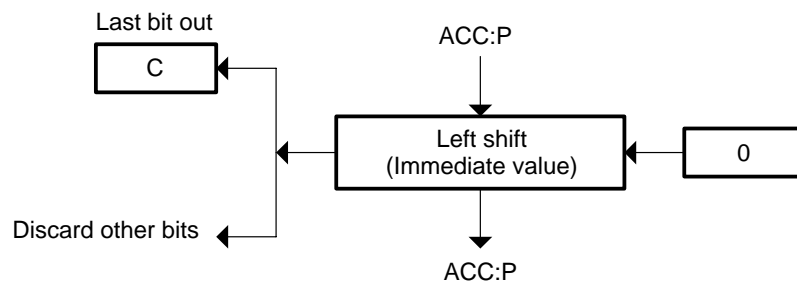
MOV     T,@VarB           ; Load T with contents of VarB
MOV     AL,@VarA          ; Load AL with contents of VarA
LSL     AL,T              ; Scale AL by value in T bits 0 to 3
MOV     @VarC,AL         ; Store result in VarC
    
```

**LSL64 ACC:P,#1..16***Logical Shift Left*

SYNTAX OPTIONS	OPCODE	OBJMODE	RPT	CYC
LSL64 ACC:P,#1..16	0101 0110 1010 SHFT	1	-	1

**Operands**    **ACC:P**    Accumulator register (ACC) and product register (P)  
                   **#1..16**    Shift value

**Description**                    Logical shift left the 64-bit combined value of the ACC:P registers by the amount specified in the shift value field. During the shift, the low order bits are zero-filled and the last bit shifted out is stored in the carry bit flag:



**Flags and- Modes**    **N**            After the shift, if bit 31 of the ACC register is 1 then ACC:P is negative and the N bit is set; otherwise N is cleared.

**Z**            After the shift, the Z flag is set if the combined 64-bit value of the ACC:P is zero; otherwise, Z is cleared.

**C**            The last bit shifted out of the combined 64-bit value is loaded into the C bit.

**Repeat**                        This instruction is not repeatable. If this instruction follows the RPT instruction, it resets the repeat counter (RPTC) and executes only once.

**Example**                        ; Logical shift left the 64-bit Var64 by 10:  
 MOVL    ACC,@Var64+2                    ; Load ACC with high 32 bits of Var64  
 MOVL    P,@Var64+0                     ; Load P with low 32 bits of Var64  
 LSL64    ACC:P,#10                     ; Logical shift left ACC:P by 10  
 MOVL    @Var64+2,ACC                  ; Store high 32-bit result into Var64  
 MOVL    @Var64+0,P                    ; Store low 32-bit result into Var64

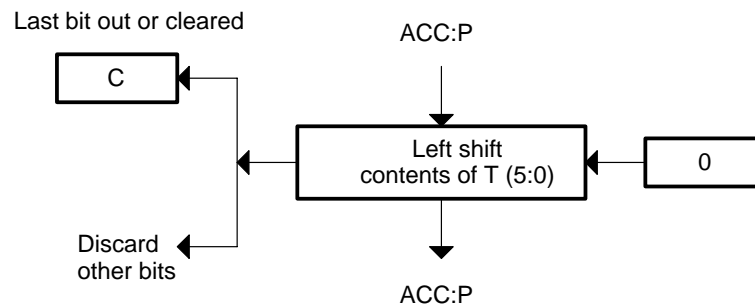
**LSL64 ACC:P,T**

64-Bit Logical Shift Left by T(5:0)

SYNTAX OPTIONS	OPCODE	OBJMODE	RPT	CYC
LSL64 ACC:P,T	0101 0110 0101 0010	1	-	1

**Operands**    **ACC:P**    Accumulator register (ACC) and product register (P)  
                   **T**            Upper 16 bits of the multiplicand register (XT)

**Description**            Logical shift left the 64-bit combined value of the ACC:P registers by the amount specified in the six least significant bits of the T register, T(5:0) = 0...63. Higher order bits are ignored. During the shift, the low order bits are zero-filled. If T specifies a shift of 0, then C is cleared; otherwise, C is filled with the last bit to be shifted out of the ACC:P registers:



**Flags and Modes**    **N**            After the shift, if bit 31 of the ACC register is 1 then ACC:P is negative and the N bit is set; otherwise N is cleared.  
                           **Z**            After the shift, the Z flag is set if the combined 64-bit value of the ACC:P is zero; otherwise, Z is cleared.  
                           **C**            If (T(5:0) = 0) clear C; otherwise, the last bit shifted out of the combined 64-bit value is loaded into the C bit.

**Repeat**                This instruction is not repeatable. If this instruction follows the RPT instruction, it resets the repeat counter (RPTC) and executes only once.

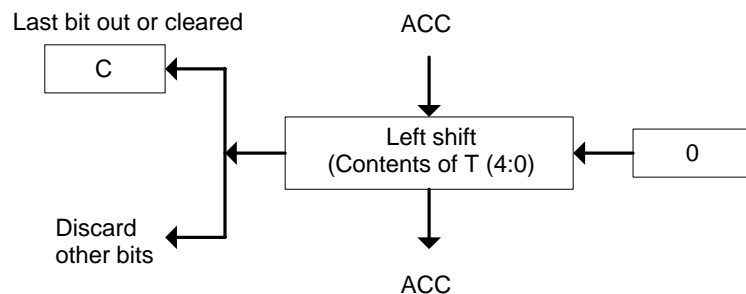
**Example**                ; Logical shift left the 64-bit Var64 by contents of Var16:  
                   MOVL    ACC,@Var64+2                    ; Load ACC with high 32 bits of Var64  
                   MOVL    P,@Var64+0                    ; Load P with low 32 bits of Var64  
                   MOV     T,@Var16                    ; Load T with shift value from Var16  
                   LSL64 ACC:P,T                    ; Logical shift left ACC:P by T(5:0)  
                   MOVL    @Var64+2,ACC                ; Store high 32-bit result into Var64  
                   MOVL    @Var64+0,P                ; Store low 32-bit result into Var64

**LSLL ACC,T***Logical Shift Left by T (4:0)*

SYNTAX OPTIONS	OPCODE	OBJMODE	RPT	CYC
LSLL ACC,T	0101 0110 0011 1011	1	-	1

<b>Operands</b>	<b>ACC</b>	Accumulator register
	<b>T</b>	Upper 16 bits of the multiplicand (XT) register
	<b>T</b>	Upper 16 bits of the multiplicand register (XT)

**Description** Perform a logical shift left on the content of the ACC register by the amount specified by the five least significant bits of the T register, T(4:0) = 0...31. Higher order bits are ignored. During the shift, the low order bits of the ACC register are zero filled. If T specifies a shift of 0, then C is cleared; otherwise, C is filled with the last bit to be shifted out of the ACC register:



**Flags and Z Modes** After the shift, the Z flag is set if the ACC value is zero, else Z is cleared. Even if the T register specifies a shift of 0, the content of the ACC register is still tested for the zero condition and Z is affected.

**N** After the shift, the N flag is set if bit 31 of the ACC is 1, else N is cleared. Even if the T register specifies a shift of 0, the content of the ACC register is still tested for the negative condition and N is affected.

**Repeat** This instruction is not repeatable. If this instruction follows the RPT instruction, it resets the repeat counter (RPTC) and executes only once.

**Example** ; Logical shift left contents of VarA by VarB:

```

MOVL   ACC,@VarA           ; ACC = VarA
MOV    T,@VarB             ; T = VarB (shift value)
LSLL   ACC,T               ; Logical shift left ACC by T(4:0)
MOVL   @VarA,ACC           ; Store result into VarA

```



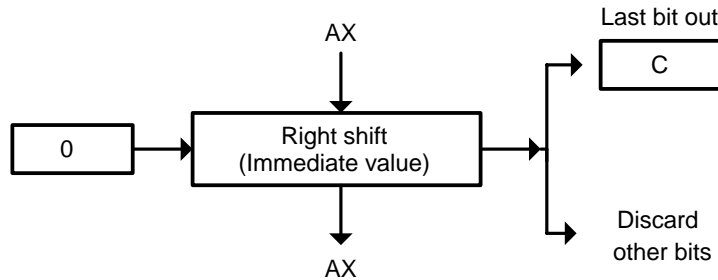
**LSR AX,#1...16**

*Logical Shift Right*

SYNTAX OPTIONS	OPCODE	OBJMODE	RPT	CYC
LSR AX,#1...16	1111 1111 110A SHFT	X	-	1

**Operands**    **AX**        Accumulator high (AH) or accumulator low (AL) register  
                   **#1...16**      Shift value

**Description**        Perform a logical right shift on the content of the specified AX register by the amount given by the "shift value" field. During the shift, the high order bits of the AX register are zero filled and the last bit to be shifted out is stored in the carry flag bit:



**Flags and Modes**    **N**        After the shift, if bit 15 of AX is 1 then the negative flag bit is set; otherwise it is cleared.  
                           **Z**        After the shift, if AX is 0, then the Z bit is set, otherwise it is cleared.  
                           **C**        The last bit to be shifted out of AH or AL is stored in C.

**Repeat**                This instruction is not repeatable. If this instruction follows the RPT instruction, it resets the repeat counter (RPTC) and executes only once.

```

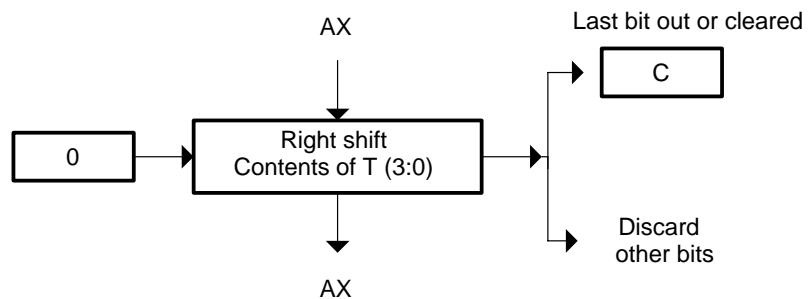
Example        ; Divide index register AR0 by 2:
MOV     AL,@AR0                                ; Load AL with contents of AR0
LSR     AL,#1                                   ; Scale result by 1 (/2)
MOV     @AR0,AL                                ; Store result back in AR0
    
```

**LSR AX,T***Logical Shift Right by T(3:0)*

SYNTAX OPTIONS	OPCODE	OBJMODE	RPT	CYC
LSR AX,T	1111 1111 0110 001A	X	-	1

**Operands**    **AX**        Accumulator high (AH) or accumulator low (AL) register  
                                  Upper 16 bits of the multiplicand (XT) register

**Description**            Perform a logical shift right on the content of the specified AX register (AH or AL) as specified by the four least significant bits of the T register, T(3:0). The contents of higher order bits are ignored. During the shift, the high order bits of the AX register are zero filled. If the T(3:0) register bits specify a shift of 0, then C is cleared; otherwise, C is filled with the last bit to be shifted out of AX:



**Flags and Modes**    **N**        After the shift, if bit 15 of AX is 1 then the negative flag bit is set; otherwise it is cleared. Even if the T(3:0) register bits specify a shift of 0, the value of AH or AL is still tested for the negative condition and N is affected.

**Z**        After the shift, if AX is 0, then the Z bit is set, otherwise it is cleared. Even if the T(3:0) register bits specify a shift of 0, the value of AH or AL is still tested for the zero condition and Z is affected.

**C**        If T(3:0) specifies a shift of 0, then C is cleared; otherwise, C is filled with the last bit to be shifted out of AH or AL.

**Repeat**                    This instruction is not repeatable. If this instruction follows the RPT instruction, it resets the repeat counter (RPTC) and executes only once.

**Example**                ; Calculate un-signed value: VarC = VarA >> VarB;  
 MOV     T,@VarB                    ; Load T with contents of VarB  
 MOV     AL,@VarA                   ; Load AL with contents of VarA  
 LSR     AL,T                         ; Scale AL by value in T bits 0 to 3  
 MOV     @VarC,AL                   ; Store result in VarC

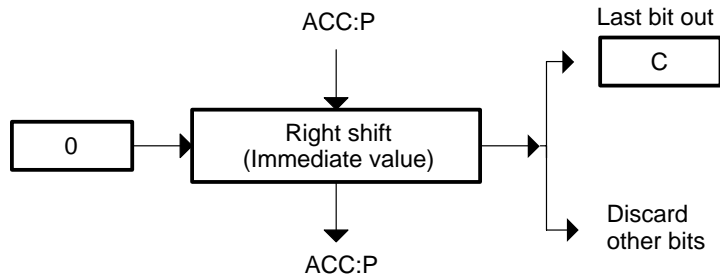
**LSR64 ACC:P,#1..16**

*64-Bit Logical Shift Right*

SYNTAX OPTIONS	OPCODE	OBJMODE	RPT	CYC
LSR64 ACC:P,#1..16	0101 0110 1001 SHFT	1	-	1

**Operands**    **ACC:P**    Accumulator register (ACC) and product register (P)  
                   **#1..16**    Shift value

**Description**                    Logical shift right the 64-bit combined value of the ACC:P registers by the amount specified in the shift value field. As the value is shifted, the most significant bits are zero filled and the last bit shifted out is stored in the carry bit flag:



**Flags and Modes**    **N**            After the shift, if bit 31 of the ACC register is 1 then ACC:P is negative and the N bit is set; otherwise N is cleared.  
                           **Z**            After the shift, the Z flag is set if the combined 64-bit value of the ACC:P is zero; otherwise, Z is cleared.  
                           **C**            The last bit shifted out of the combined 64-bit value is loaded into the C bit.

**Repeat**                            This instruction is not repeatable. If this instruction follows the RPT instruction, it resets the repeat counter (RPTC) and executes only once.

**Example**                            ; Logical shift right the 64-bit Var64 by 10:  
                   MOVL    ACC,@Var64+2                            ; Load ACC with high 32 bits of Var64  
                   MOVL    P,@Var64+0                            ; Load P with low 32 bits of Var64  
                   LSR64    ACC:P,#10                            ; Logical shift right ACC:P by 10  
                   MOVL    @Var64+2,ACC                            ; Store high 32-bit result into Var64  
                   MOVL    @Var64+0,P                            ; Store low 32-bit result into Var64

**LSR64 ACC:P,T**

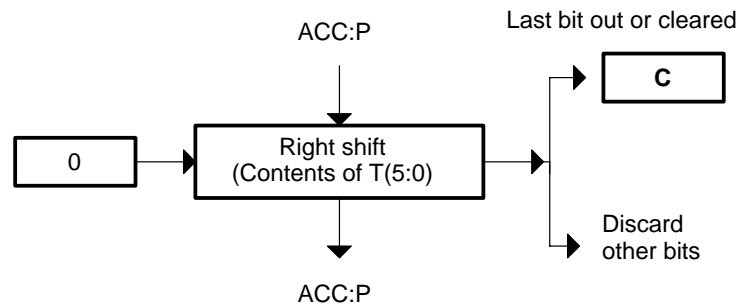
64-Bit Logical Shift Right by T(5:0)

SYNTAX OPTIONS	OPCODE	OBJMODE	RPT	CYC
LSR64 ACC:P,T	0101 0110 0101 1011	1	-	1

**Operands** ACC:P Accumulator register (ACC) and product register (P)

T Upper 16 bits of the multiplicand register (XT)

**Description** Logical shift right the 64-bit combined value of the ACC:P registers by the amount specified by the six least significant bits of the T register, T(5:0) = 0..63. Higher order bits are ignored. As the value is shifted, the most significant bits are zero filled. If T specifies a shift of 0, then C is cleared; otherwise, C is filled with the last bit to be shifted out of the ACC:P registers:



**Flags and Modes**

**N** After the shift, if bit 31 of the ACC register is 1 then ACC:P is negative and the N bit is set; otherwise N is cleared.

**Z** After the shift, the Z flag is set if the combined 64-bit value of the ACC:P is zero; otherwise, Z is cleared.

**C** If (T(5:0) = 0) clear C; otherwise, the last bit shifted out of the combined 64-bit value is loaded into the C bit.

**Repeat** This instruction is not repeatable. If this instruction follows the RPT instruction, it resets the repeat counter (RPTC) and executes only once.

**Example**

```

; Arithmetic shift right the 64-bit Var64 by contents of Var16:
MOVL  ACC,@Var64+2          ; Load ACC with high 32 bits of Var64
MOVL  P,@Var64+0           ; Load P with low 32 bits of Var64
MOV   T,@Var16             ; Load T with shift value from Var16
LSR64 ACC:P,T              ; Logical shift right ACC:P by T(5:0)
MOVL  @Var64+2,ACC         ; Store high 32-bit result into Var64
MOVL  @Var64+0,P          ; Store low 32-bit result into Var64

```

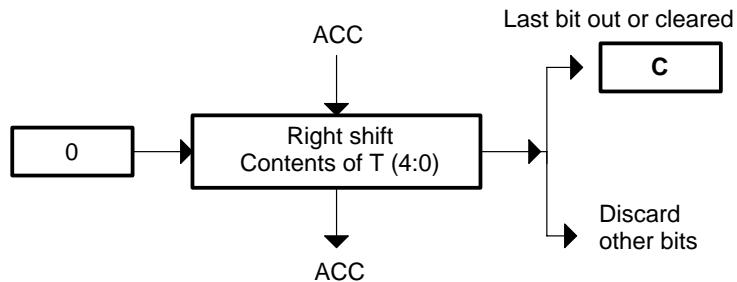
**LSRL ACC,T**

*Logical Shift Right by T (4:0)*

SYNTAX OPTIONS	OPCODE	OBJMODE	RPT	CYC
LSRL ACC,T	0101 0110 0010 0010	1	-	1

**Operands**    **ACC**    Accumulator register  
                   **T**        Upper 16 bits of the multiplicand (XT) register

**Description**            Perform a logical shift right on the content of the ACC register as specified by the five least significant bits of the T register, T(4:0) = 0...31. Higher order bits are ignored. During the shift, the high order bits of ACC are zero-filled. If T specifies a shift of 0, then C is cleared; otherwise, C is filled with the last bit to be shifted out of the ACC register:



**Flags and Modes**    **Z**        After the shift, the Z flag is set if the ACC value is zero, else Z is cleared. Even if the T register specifies a shift of 0, the content of the ACC register is still tested for the zero condition and Z is affected.

**N**        After the shift, the N flag is set if bit 31 of the ACC is 1, else N is cleared. Even if the T register specifies a shift of 0, the content of the ACC register is still tested for the negative condition and N is affected.

**C**        If (T(4:0) = 0) then C is cleared; otherwise, the last bit shifted out is loaded into the C flag bit.

**Repeat**                    This instruction is not repeatable. If this instruction follows the RPT instruction, it resets the repeat counter (RPTC) and executes only once.

```

Example            ; Logical shift right contents of VarA by VarB:
MOV    ACC,@VarA            ; ACC = VarA
MOV    T,@VarB             ; T = VarB (shift value)
LSRL   ACC,T                ; Logical shift right ACC by T(4:0)
MOV    @VarA,ACC            ; Store result into VarA
  
```

**MAC P,loc16,0:pma***Multiply and Accumulate*

SYNTAX OPTIONS	OPCODE	OBJMODE	RPT	CYC
MAC P,loc16,0:pma	0001 0100 LLLL LLLL CCCC CCCC CCCC CCCC	X	Y	N+2

**Operands**

**P** Product register

**loc16** Addressing mode (see Chapter 5)

**0:pma** Immediate program memory address, access low 64K range of program space only (0x000000 to 0x00FFFF)

**Description**

- 1) Add the previous product (stored in the P register), shifted as specified by the product shift mode (PM), to the ACC register.
- 2) Load the T register with the content of the location pointed to by the "loc16" addressing mode.
- 3) Multiply the signed 16-bit content of the T register by the signed 16-bit content of the addressed program memory location and store the 32-bit result in the P register:

```
ACC = ACC + P << PM;
T = [loc16];
P = signed T * signed Prog[0x00:pma];
```

The C28x forces the upper 6 bits of the program memory address, specified by the "0:pma" addressing mode, to 0x00 when using this form of the MAC instruction. This limits the program memory address to the low 64K of program address space (0x000000 to 0x00FFFF). On the C28x devices, memory blocks are mapped to both program and data space (unified memory), hence the "0:pma" addressing mode can be used to access data space variables that fall within its address range.

**Flags and Modes**

**Z** After the addition, the Z flag is set if the ACC value is zero, else Z is cleared.

**N** After the addition, the N flag is set if bit 31 of the ACC is 1, else N is cleared.

**C** If the addition generates a carry, C is set; otherwise C is cleared.

**V** If an overflow occurs, V is set; otherwise V is not affected.

**OVC** If overflow mode is disabled; and if the operation generates a positive overflow, then the counter is incremented. If overflow mode is disabled; and if the operation generates a negative overflow, then the counter is decremented.

**OVM** If overflow mode bit is set; then the ACC value will saturate maximum positive (0x7FFFFFFF) or maximum negative (0x80000000) if the operation overflowed.

**PM** The value in the PM bits sets the shift mode for the output operation from the product register. If the product shift value is positive (logical left shift operation), then the low bits are zero filled. If the product shift value is negative (arithmetic right shift operation), the upper bits are sign extended.

**Repeat** This instruction is repeatable. If the operation follows a RPT instruction, then it will be executed N+1 times. The state of the Z, N, C and OVC flags will reflect the final result. The V flag will be set if an intermediate overflow occurs. When repeated, the program-memory address is incremented by 1 during each repetition.

**Example**

```
; Calculate sum of product using 16-bit multiply:
; int16 X[N] ; Data information
; int16 C[N] ; Coefficient information, located in low 64K
; sum = 0;
; for(i=0; i < N; i++)
; sum = sum + (X[i] * C[i]) >> 5;
MOVL XAR2,#X ; XAR2 = pointer to X
SPM -5 ; Set product shift to ">> 5"
ZAPA ; Zero ACC, P, OVC
RPT #N-1 ; Repeat next instruction N times
| |MAC P,*XAR2++,0:C ; ACC = ACC + P >> 5,
; P = *XAR2++ * *C++
ADDL ACC,P << PM ; Perform final accumulate
MOVL @sum,ACC ; Store final result into sum
```

**MAC P,loc16,\*XAR7/++***Multiply and Accumulate*

SYNTAX OPTIONS	OPCODE	OBJMODE	RPT	CYC
MAC P, loc16, *XAR7	0101 0110 0000 0111 1100 0111 LLLL LLLL	1	Y	N+2
MAC P, loc16, *XAR7++	0101 0110 0000 0111 1000 0111 LLLL LLLL	1	Y	N+2

<b>Operands</b>	<b>P</b>	Product register
	<b>loc16</b>	Addressing mode (see Chapter 5)
	<b>*XAR7</b> <b>/++</b>	Indirect program-memory addressing using auxiliary register XAR7, can access full 4M x 16 program space range (0x000000 to 0x3FFFFFF)

**Description** Use the following steps for this instruction:

- 1) Add the previous product (stored in the P register), shifted as specified by the product shift mode (PM), to the ACC register.
- 2) Load the T register with the content of the location pointed to by the "loc16" addressing mode.
- 3) Multiply the signed 16-bit content of the T register by the signed 16-bit content of the program memory location pointed to by the XAR7 register and store the 32-bit result in the P register. If specified, post-increment the XAR7 register by 1:

```
ACC = ACC + P << PM;
T = [loc16];
P = signed T * signed Prog[*XAR7 or *XAR7++];
```

On the C28x devices, memory blocks are mapped to both program and data space (unified memory), hence the "XAR7/++" addressing mode can be used to access data space variables that fall within the program space address range.

With some addressing mode combinations, you can get conflicting references. In such cases, the C28x will give the "loc16/loc32" field priority on changes to XAR7. For example:

```
MAC P, *--XAR7, *XAR7++ ; --XAR7 given priority
MAC P, *XAR7++, *XAR7 ; *XAR7++ given priority
MAC P, *XAR7, *XAR7++ ; *XAR7++ given priority
```



<b>Flags and Modes</b>	<b>Z</b>	After the addition, the Z flag is set if the ACC value is zero, else Z is cleared.
	<b>N</b>	After the addition, the N flag is set if bit 31 of the ACC is 1, else N is cleared.
	<b>C</b>	If the addition generates a carry, C is set; otherwise C is cleared.
	<b>V</b>	If an overflow occurs, V is set; otherwise V is not affected.
	<b>OVC</b>	If overflow mode is disabled; and if the operation generates a positive overflow, then the counter is incremented. If overflow mode is disabled; and if the operation generates a negative overflow, then the counter is decremented.
	<b>OVM</b>	If overflow mode bit is set; then the ACC value will saturate maximum positive (0x7FFFFFFF) or maximum negative (0x80000000) if the operation overflowed.
	<b>PM</b>	The value in the PM bits sets the shift mode for the output operation from the product register. If the product shift value is positive (logical left shift operation), then the low bits are zero filled. If the product shift value is negative (arithmetic right shift operation), the upper bits are sign extended.

**Repeat** This instruction is repeatable. If the operation follows a RPT instruction, then it will be executed N+1 times. The state of the Z, N, C and OVC flags will reflect the final result. The V flag will be set if an intermediate overflow occurs.

**Example**

```

; Calculate sum of product using 16-bit multiply:
; int16 X[N] ; Data information
; int16 C[N] ; Coefficient information (located in low 4M)
; sum = 0;
; for(i=0; i < N; i++)
; sum = sum + (X[i] * C[i]) >> 5;
MOVL XAR2,#X ; XAR2 = pointer to X
MOVL XAR7,#C ; XAR7 = pointer to C
SPM -5 ; Set product shift to ">> 5"
ZAPA ; Zero ACC, P, OVC
RPT #N-1 ; Repeat next instruction N times
| |MAC P,*XAR2++,*XAR7++ ; ACC = ACC + P >> 5,
; P = *XAR2++ * *XAR7++
ADDL ACC,P << PM ; Perform final accumulate
MOVL @sum,ACC ; Store final result into sum

```

**MAX AX, loc16***Find the Maximum*

SYNTAX OPTIONS	OPCODE	OBJMODE	RPT	CYC
MAX AX, loc16	0101 0110 0111 001A 0000 0000 LLLL LLLL	1	Y	N+1

**Operands**    **AX**        Accumulator high (AH) or accumulator low (AL) register  
                   **loc16**      Addressing modes (see Chapter 5)

**Description**            Compare the signed contents of the specified AX register (AH or AL) with the signed content of the location pointed to by the "loc16" addressing mode and load the AX register with the larger of these two values:

```
if (AX < [loc16]), AX = [loc16];
if (AX >= [loc16]), AX = unchanged;
```

**Flags and Modes**        **N**        If AX is less than the contents of the addressed location (AX < [loc16]) then the negative flag bit will be set; otherwise, it will be cleared.  
                               **Z**        If AX and the contents of the addressed location are equal (AX = [loc16]) then the zero flag bit will be set; otherwise, it will be cleared.  
                               **V**        If AX is less than the contents of the addressed location (AX < [loc16]) then the overflow flag bit will be set. This instruction cannot clear the V flag.

**Repeat**                    If the operation is follows a RPT instruction, the instruction will be executed N+1 times. The state of the N, Z, and V flags will reflect the final result.

**Example**                ; Saturate VarA as follows:  
                               ; if (VarA > 2000) VarA = 2000;  
                               ; if (VarA < -2000) VarA = -2000;  
 MOV    AL, @VarA                                ; Load AL with contents of VarA  
 MOV    @AH, #2000                              ; Load AH with the value 2000  
 MIN    AL, @AH                                 ; if (AL > AH) AL = AH  
 NEG    AH                                       ; AH = -2000  
 MAX    AL, @AH                                 ; if (AL < AH) AL = AH  
 MOV    @VarA, AL                               ; Store result into VarA

**MAXCUL P,loc32***Conditionally Find the Unsigned Maximum*

SYNTAX OPTIONS	OPCODE	OBJMODE	RPT	CYC
MAXCUL P,loc32	0101 0110 0101 0001 0000 0000 LLLL LLLL	1	-	1

**Operands**    **P**        **Product register**

**loc32**    Addressing mode (see Chapter 5)

**Description**        Based on the state of the N and Z flags, conditionally compare the unsigned contents of the P register with the 32-bit, unsigned content of the location pointed to by the "loc32" addressing mode and load the P register with the larger of the two numbers:

```

if( (N=1) & (Z=0) )
    P = [loc32];
if( (N=0) & (Z=1) & (P < [loc32]) )
    V=1, P = [loc32];
if( (N=0) & (Z=0) )
    P = unchanged;

```

**Note:** The "P < [loc32]" operation is treated like a 32-bit unsigned compare.

This instruction is typically combined with the MAXL instruction to form a 64-bit maximum function. It is assumed that the N and Z flags will first be set by using a MAXL instruction to compare the upper 32 bits of a 64-bit value. The MAXCUL instruction is then used to conditionally compare the lower 32 bits based on the results of the upper 32-bit comparison.

**Flags and Modes**

**N**        If (N = 1 and z = 0) then load P with [loc32].

**Z**        If (N = 0 and Z = 1) compare the unsigned content of the P with the unsigned [loc32] and load P with the larger of the two.

                  If (N = 0 and Z = 0) do nothing.

**V**        If (N = 0 AND Z = 1 AND P < [loc32] ) then V is set; otherwise, V is unchanged.

**Repeat**                This instruction is not repeatable. If this instruction follows the RPT instruction, it resets the repeat counter (RPTC) and executes only once.

**Example**     ; Saturate 64-bit Var64 as follows:  
              ; if (Var64 > MaxPos64 ) Var64 = MaxPos64  
              ; if (Var64 < MaxNeg64 ) Var64 = MaxNeg64  
MOVL ACC,@Var64+2                 ; Load ACC:P with Var64  
MOVL P,@Var64+0  
MINL ACC,@MaxPos64+2             ; if (ACC:P > MaxPos64) ACC:P = MaxPos64  
MINCUL P,@MaxPos64+0  
SB     saturate,OV  
MAXL ACC,@MaxNeg64+2             ; if (ACC:P < MaxNeg64) ACC:P = MaxNeg64  
MAXCUL P,@MaxNeg64+0  
Saturate:  
MOVL @Var64+2,ACC                 ; Store result into Var64  
MOVL @Var64,P

**MAXL ACC,loc32***Find the 32-bit Maximum*

SYNTAX OPTIONS	OPCODE	OBJMODE	RPT	CYC
MAXL ACC,loc32	0101 0110 0110 0001 0000 0000 LLLL LLLL	1	Y	N+1

**Operands**    **ACC**    Accumulator register  
                  **loc32**    Addressing mode (see Chapter 5)

**Description**            Compare the content of the ACC register with the location pointed to by the “loc32” addressing mode and load the ACC register with the larger of these two values:

```
if(ACC < [loc32]), ACC = [loc32];
if(ACC >= [loc32]), ACC = unchanged;
```

**Flags and Modes**    **Z**            If ACC is equal to the contents of the addressed location (ACC = [loc32]), set Z; otherwise, clear Z.

**N**            If ACC is less than the contents of the addressed location, (ACC < [loc32]), set N; otherwise clear N. The MAXL instruction assumes infinite precision when it determines the sign of the result. For example, consider the subtraction 0x8000 0000 – 0x0000 0001. If the precision were limited to 32 bits, the result would cause an overflow to the positive number 0x7FFF FFFF and N would be cleared. However, because the MAXL instruction assumes infinite precision, it would set N to indicate that 0x8000 0000 – 0x0000 0001 actually results in a negative number.

**C**            If (ACC – [loc32]) generates a borrow, clear the C bit; otherwise set C.

**V**            If ACC is less than the contents of the addressed location (ACC < [loc32]), set V. This instruction cannot clear the V flag.

**Repeat**                This instruction is repeatable. If the operation follows a RPT instruction, then the MAXL instruction will be executed N+1 times. The state of the Z, N, and C flags will reflect the final result. The V flag will be set if an intermediate overflow occurs.

**Example**                ; Saturate VarA as follows:  
                  ; if (VarA > MaxPos) VarA = MaxPos  
                  ; if (VarA < MaxNeg) VarA = MaxNeg  
                  MOVL    ACC,@VarA                            ; ACC = VarA  
                  MINL    ACC,@MaxPos                        ; if (ACC > MaxPos) ACC = MaxPos  
                  MAXL    ACC,@MaxNeg                        ; if (ACC < MaxNeg) ACC = MaxNeg  
                  MOVL    @VarA,ACC                           ; Store result into VarA

**MIN AX, loc16***Find the Minimum*

SYNTAX OPTIONS	OPCODE	OBJMODE	RPT	CYC
MIN AX, loc16	0101 0110 0111 010A 0000 0000 LLLL LLLL	1	Y	N+1

**Operands**    **AX**        Accumulator high (AH) or accumulator low (AL) register

**loc16**      Addressing modes (see Chapter 5)

**Description**            Compare the signed content of the specified AX register (AH or AL) with the content of the signed location pointed to by the "loc16" addressing mode and load the AX register with the smaller of these two values:

```
if (AX > [loc16]), AX = [loc16];
if (AX <= [loc16]), AX = unchanged;
```

**Flags and Modes**    **N**            If AX is less than the contents of the addressed location (AX < [loc16]) then the negative flag bit will be set; otherwise, it will be cleared.

**Z**            If AX and the contents of the addressed location are equal (AX = [loc16]) then the zero flag bit will be set; otherwise, it will be cleared.

**V**            If AX is greater than the contents of the addressed location (AX > [loc16]) then the overflow flag bit will be set. This instruction cannot clear the V flag.

**Repeat**                    If the operation is follows a RPT instruction, the instruction will be executed N+1 times. The state of the N, Z and V flags will reflect the final result.

**Example**                ; Saturate VarA as follows:  
                          ; if (VarA > 2000) VarA = 2000;  
                          ; if (VarA < -2000) VarA = -2000;  
 MOV    AL, @VarA                                ; Load AL with contents of VarA  
 MOV    @AH, #2000                               ; Load AH with the value 2000  
 MIN    AL, @AH                                 ; if (AL > AH) AL = AH  
 NEG    AH                                       ; AH = -2000  
 MAX    AL, @AH                                 ; if (AL < AH) AL = AH  
 MOV    @VarA, AL                               ; Store result into VarA

**MINCUL P,loc32**

*Conditionally Find the Unsigned Minimum*

SYNTAX OPTIONS	OPCODE	OBJMODE	RPT	CYC
MINCUL P,loc32	0101 0110 0101 1001 xxxx xxxx LLLL LLLL	1	-	1

**Operands**    **P**            Product register  
                  **loc32**        Addressing mode (see Chapter 5)

**Description**                Based on the state of the N and Z flags, conditionally compare the unsigned contents of the P register with the 32-bit, unsigned content of the location pointed to by the “loc32” addressing mode and load the P register with the smaller of the two numbers:

```

if( (N = 0) & (Z = 0) )
    P = [loc32];
if( (N = 0) & (Z = 1) & (P > [loc32]) )
    V=1, P = [loc32];
if( (N = 1) & (Z = 0) )
    P = unchanged;
    
```

**Note:** The “p < [loc32]” operation is treated like a 32-bit unsigned compare.

This instruction is typically combined with the MINL instruction to form a 64-bit minimum function. It is assumed that the N and Z flags will first be set by using a MINL instruction to compare the upper 32 bits of a 64-bit value. The MINCUL instruction is then used to conditionally compare the lower 32 bits based on the results of the upper 32-bit comparison.

**Flags and Modes**    **N**            If (N = 1 AND Z = 0), then load the P register with [loc32].  
                          **Z**            If (N = 0 AND Z = 1), compare unsigned and load P with the smaller P register to [loc32].  
                                         If (N = 0 AND Z = 0), do nothing.  
                          **V**            If (N = 0 AND Z = 1 AND P < [loc32] ) then V is set; otherwise, V is unchanged.

**Repeat**                        This instruction is not repeatable. If this instruction follows the RPT instruction, it resets the repeat counter (RPTC) and executes only once.

```

Example                    ; Saturate 64-bit Var64 as follows:
; if (Var64 > MaxPos64 ) Var64 = MaxPos64
; if (Var64 < MaxNeg64 ) Var64 = MaxNeg64
MOVL  ACC,@Var64+2                ; Load ACC:P with Var64
MOVL  P,@Var64+0
MINL  ACC,@MaxPos64+2             ; if (ACC:P > MaxPos64) ACC:P = MaxPos64
MINCUL P,@MaxPos64+0
MAXL  ACC,@MaxNeg64+2             ; if (ACC:P < MaxNeg64) ACC:P = MaxNeg64
MAXCUL P,@MaxNeg64+0
MOVL  @Var64+2,ACC                ; Store result into Var64
MOVL  @Var64+0,P
    
```

**MINL ACC,loc32***Find the 32-bit Minimum*

SYNTAX OPTIONS	OPCODE	OBJMODE	RPT	CYC
MINL ACC,loc32	0101 0110 0101 0000 0000 0000 LLLL LLLL	1	Y	N+1

**Operands**    **ACC**    Accumulator register

**loc32**    Addressing mode (see Chapter 5)

**Description**            Compare the content of the ACC register with the location pointed to by the “loc32” addressing mode and load the ACC register with the smaller of these two values:

```
if(ACC <= [loc32]), ACC = unchanged;
if(ACC > [loc32]), ACC = [loc32];
```

**Flags and Modes**    **Z**            If ACC is equal to the contents of the addressed location (ACC = [loc32]), set Z; otherwise clear Z.

**N**            If ACC is less than the contents of the addressed location, (ACC < [loc32]), set N; otherwise clear N. The MINL instruction assumes infinite precision when it determines the sign of the result. For example, consider the subtraction 0x8000 0000 – 0x0000 0001. If the precision were limited to 32 bits, the result would cause an overflow to the positive number 0x7FFF FFFF and N would be cleared. However, because the MINL instruction assumes infinite precision, it would set N to indicate that 0x8000 0000 – 0x0000 0001 actually results in a negative number.

**C**            If (ACC – [loc32]) generates a borrow, clear the C bit; otherwise set C.

**V**            If ACC is greater than the contents of the addressed location (ACC < [loc32]), set V. This instruction cannot clear the V flag.

**Repeat**                    This instruction is repeatable. If the operation follows a RPT instruction, then the MINL instruction will be executed N+1 times. The state of the Z, N, and C flags will reflect the final result. The V flag will be set if an intermediate overflow occurs.

**Example**                    ; Saturate VarA as follows:  
                              ; if(VarA > MaxPos) VarA = MaxPos  
                              ; if(VarA < MaxNeg) VarA = MaxNeg  
                              MOVL ACC,@VarA                    ; ACC = VarA  
                              MINL ACC,@MaxPos                ; if(ACC > MaxPos) ACC = MaxPos  
                              MAXL ACC,@MaxNeg                ; if(ACC < MaxNeg) ACC = MaxNeg  
                              MOVL @VarA,ACC                 ; Store result into VarA



**MOV \*(0:16bit), loc16**

*Move Value*

SYNTAX OPTIONS	OPCODE	OBJMODE	RPT	CYC
MOV *(0:16bit),loc16	1111 0100 LLLL LLLL CCCC CCCC CCCC CCCC	X	Y	N+2

**Operands**    **\*(0:16bit)**    Immediate direct memory address, access low 64K range of data space only (0x00000000 to 0x0000FFFF)

**loc16**            Addressing mode (see Chapter 5)

**Description**                    Move the content of the location pointed to by the “loc16” addressing mode to the memory location specified by the “0:16bit” constant address:

[0x0000:16bit] = [loc16];

**Flags and Modes**                    None

**Repeat**                            This instruction is repeatable. If the operation follows a RPT instruction, then it will be executed N+1 times. When repeated, the “(0:16bit)” data-memory address is post-incremented by 1 during each repetition. Only the lower 16 bits of the address is affected.

```
; Copy the contents of Array1 to Array2:
; int16 Array1[N];
; int16 Array2[N]; // Located in low 64K of data space
; for(i=0; i < N; i++)
;   Array2[i] = Array1[i];
```

**Example**

```
MOVL XAR2,#Array1                    ; XAR2 = pointer to Array1
RPT #(N-1)                            ; Repeat next instruction N times
|MOV *(0:Array2),*XAR2++            ; Array2[i] = Array1[i],
; i++
```

**MOV ACC,#16bit<<#0..15***Load Accumulator With Shift*

SYNTAX OPTIONS	OPCODE	OBJ-MODE	RPT	CYC
MOV ACC,loc16<<#0..15	1111 1111 0010 SHFT CCCC CCCC CCCC CCCC	X	-	1

**Operands**

**ACC** Accumulator register

**#16bit** 16-bit immediate constant value

**#0..15** Shift value (default is "<< #0" if no value specified)

**Description**

Load the ACC register with the left shifted contents of the 16-bit immediate value. The shifted value is sign extended if sign extension mode is turned on (SXM = 1) else the shifted value is zero extended (SXM = 0). The lower bits of the shifted value are zero filled:

```
if(SXM = 1) // sign extension mode enabled
    ACC = S:16bit << shift value;
else // sign extension mode disabled
    ACC = 0:16bit << shift value;
```

**Flags and Modes**

**N** After the load, the N flag is set if bit 31 of the ACC is 1, else N is cleared.

**Z** After the load, the Z flag is set if the ACC value is zero, else Z is cleared.

**SXM** If sign extension mode bit is set; then the 16-bit constant operand will be sign extended before the load; else, the value will be zero extended.

**Repeat**

This instruction is not repeatable. If this instruction follows the RPT instruction, it resets the repeat counter (RPTC) and executes only once.

**Example**

```
; Calculate signed value: ACC = -2010 << 10 + VarB << 6;
SETC SXM ; Turn sign extension mode on
MOV ACC,#-2010 << #10 ; Load ACC with -2010 left shifted by
10
ADD ACC,@VarB << #6 ; Add VarB left shifted by 6 to ACC
```

**MOV ACC,loc16<<T***Load Accumulator With Shift*

SYNTAX OPTIONS	OPCODE	OBJ-MODE	RPT	CYC
MOV ACC,loc16 << T	0101 0110 0000 0110 0000 0000 LLLL LLLL	1	-	1

**Operands**

**ACC** Accumulator register

**loc16** Addressing mode (see Chapter 5)

**T** Upper 16 bits of the multiplicand register, XT(31:16)

**Description**

Load the ACC register with the left-shifted contents of the 16-bit location pointed to by the "loc16" addressing mode. The shift value is specified by the four least significant bits of the T register, T(3:0) = shift value = 0..15. Higher order bits are ignored. The shifted value is sign extended if sign extension mode is turned on (SXM = 1) else the shifted value is zero extended (SXM = 0). The lower bits of the shifted value are zero filled:

```
if(SXM = 1) // sign extension mode enabled
    ACC = S:[loc16] << T(3:0);
else // sign extension mode disabled
    ACC = 0:[loc16] << T(3:0);
```

**Flags and Modes**

**N** After the load, the N flag is set if bit 31 of the ACC is 1, else N is cleared.

**Z** After the load, the Z flag is set if the ACC value is zero, else Z is cleared.

**SXM** If sign extension mode bit is set; then the 16-bit operand, addressed by the "loc16" field, will be sign extended before the load; else the value will be zero extended.

**Repeat**

This instruction is not repeatable. If this instruction follows the RPT instruction, it resets the repeat counter (RPTC) and executes only once.

**Example**

```
; Calculate signed value: ACC = (VarA << SB) + (VarB << SB)
SETC SXM                                ; Turn sign extension mode on
MOV T,@SA                                ; Load T with shift value in SA
MOV ACC,@VarA << T                        ; Load in ACC shifted contents of VarA
MOV T,@SB                                  ; Load T with shift value in SB
ADD ACC,@VarB << T                        ; Add to ACC shifted contents of VarB
```

**MOV ACC, loc16<<#0..16***Load Accumulator With Shift*

SYNTAX OPTIONS	OPCODE	OBJ-MODE	RPT	CYC
MOV ACC,loc16<<#0	1000 0101 LLLL LLLL	1	–	1
	1110 0000 LLLL LLLL	0	–	1
MOV ACC, loc16<<#1..15	0101 0110 0000 0011	1	–	1
	0000 SHFT LLLL LLLL			
	1110 SHFT LLLL LLLL	0	–	1
MOV ACC, loc16<<#16	0010 0101 LLLL LLLL	X	–	1

**Operands**

**ACC** Accumulator register

**loc16** Addressing mode (see Chapter 5)

**#0..16** Shift value (default is "<< #0" if no value specified)

**Description**

Load the ACC register with the left shifted contents of the addressed location pointed to by the "loc16" addressing mode. The shifted value is sign extended if sign extension mode is turned on (SXM = 1) else the shifted value is zero extended (SXM = 0). The lower bits of the shifted value are zero filled:

```
if(SXM = 1) // sign extension mode enabled
    ACC = S:[loc16] << shift value;
else // sign extension mode disabled
    ACC = 0:[loc16] << shift value;
```

**Flags and Modes**

**N** After the load, the N flag is set if bit 31 of the ACC is 1, else N is cleared.

**Z** After the load, the Z flag is set if the ACC is zero, else Z is cleared.

**SXM** If sign extension mode bit is set; then the 16-bit operand, addressed by the "loc16" field, will be sign extended before the load; else the value will be zero extended.

**Repeat**

This instruction is not repeatable. If this instruction follows the RPT instruction, it resets the repeat counter (RPTC) and executes only once.

**Example**

```
; Calculate signed value: ACC = VarA << 10 + VarB << 6;
SETC SXM ; Turn sign extension mode on
MOV ACC,@VarA << #10 ; Load ACC with VarA left shifted by 10
ADD ACC,@VarB << #6 ; Add VarB left shifted by 6 to ACC
```

**MOV AR6/7, loc16***Load Auxiliary Register*

SYNTAX OPTIONS	OPCODE	OBJ-MODE	RPT	CYC
MOV AR6, loc16	0101 1110 LLLL LLLL	X	-	1
MOV AR7, loc16	0101 1111 LLLL LLLL	X	-	1

**Operands**    **AR6/7**    AR6 or AR7, auxiliary registers  
                   **loc16**    Addressing mode (see Chapter 5)

**Description**                    Load AR6 or AR7 with the contents of the 16-bit location and leave the upper 16 bits of XAR6 and XAR7 unchanged:

AR6/7 = [loc16];  
 AR6/7H = unchanged;

**Flags and Modes**                None

**Repeat**                            This instruction is not repeatable. If this instruction follows the RPT instruction, it resets the repeat counter (RPTC) and executes only once.



**MOV DP, #10bit***Load Data-Page Pointer*

SYNTAX OPTIONS	OPCODE	OBJMODE	RPT	CYC
MOV DP, #10bit	1111 10CC CCCC CCCC	X	-	1

**Operands**    **DP**    Data page register  
                  **#10bit**    10-bit immediate constant value

**Description**            Load the data page register with a 10-bit constant leaving the upper 6 bits unchanged:

DP(9:0) = 10bit;  
 DP(15:10) = unchanged;

**Flags and Modes**            None

**Repeat**                    This instruction is not repeatable. If this instruction follows the RPT instruction, it resets the repeat counter (RPTC) and executes only once.

**Example**            MOV DP, #VarA                                    ; Load DP with the data page that  
    ; contains VarA. Assumes VarA is in  
    ; the lower 0x0000 FFC0 of memory.  
    ; DP(15:10) is left unchanged.

**MOV IER,loc16***Load the Interrupt-Enable Register*

SYNTAX OPTIONS	OPCODE	OBJMODE	RPT	CYC
MOV IER,loc16	0010 0011 LLLL LLLL	X	-	5

**Operands**

**IER**      Interrupt-enable register

**loc16**     Addressing mode (see Chapter 5)

**Description**

Enable and disable selected interrupts by loading the content of the location pointed to by the "loc16" addressing mode into the IER register:

IER = [loc16];

**Flags and Modes**

None

**Repeat**

This instruction is not repeatable. If this instruction follows the RPT instruction, it resets the repeat counter (RPTC) and executes only once.

**Example**

```
; Push the contents of IER on the stack and load IER with the
; contents of VarA:
MOV  *SP++,IER                ; Save IER on stack
MOV  IER,@VarA                ; Load IER with contents of VarA
```



**MOV loc16, #16bit**

Save 16-bit Constant

SYNTAX OPTIONS	OPCODE	OBJMODE	RPT	CYC
MOV loc16, #16bit	0010 1000 LLLL LLLL CCCC CCCC CCCC CCCC	X	Y	N+1

**Operands**    **loc16**    Addressing mode (see Chapter 5)  
                   **#16bit**    16-bit constant immediate value

**Description**                    Load the location pointed to by the “loc16” addressing mode with the 16-bit constant immediate value:

[loc16] = 16bit;

**Note:** For #16bit = #0, see the MOV loc16, #0 instruction on page 6-166.

Smart Encoding:

If loc16 = AL or AH and #16bit is an 8-bit number, then the assembler will encode this instruction as MOVB AX, #8bit to improve efficiency. To override this, use the MOVW AX, #16bit alias instruction.

**Flags and Modes**

**N**                    If (loc16 = @AX), then the load to AX is tested for a negative condition. The negative flag bit is set if bit 15 of AX is 1, otherwise it is cleared.

**Z**                    If (loc16 = @AX), then the load to AX is tested for a zero condition. The bit is set if the result of the operation on the AX register generates a 0 value, otherwise it is cleared.

**Repeat**                    This instruction is not repeatable. If this instruction follows the RPT instruction, it resets the repeat counter (RPTC) and executes only once.

**Example**

```

; Initialize the contents of Array1 with 0xFFFF:
; int16 Array1[N];
; for(i=0; i < N; i++)
;   Array1[i] = 0xFFFF;
MOVL XAR2, #Array1                    ; XAR2 = pointer to Array1
RPT # (N-1)                            ; Repeat next instruction N times
| |MOV *XAR2++, #0xFFFF              ; Array1[i] = 0xFFFF,
; i++

```

**MOV loc16, \*(0:16bit)***Move Value*

SYNTAX OPTIONS	OPCODE	OBJMODE	RPT	CYC
MOV loc16, *(0:16bit)	1111 0101 LLLL LLLL CCCC CCCC CCCC CCCC	X	Y	N+2

**Operands**    **loc16**    Addressing mode (see Chapter 5)

**\*(0:16bit)**    Immediate direct memory address, access low 64K range of data space only (0x00000000 to 0x0000FFFF)

**Description**                    Move the content of the location specified by the constant direct memory address "0:16bit" into the location pointed to by the "loc16" addressing mode:

```
[loc16] = [0x0000:16bit];
```

**Flags and Modes**            **N**            If (loc16 = @AX), then the load to AX is tested for a negative condition. The negative flag bit is set if bit 15 of AX is 1, otherwise it is cleared.

**Z**            If (loc16 = @AX), then the load to AX is tested for a zero condition. The bit is set if the result of the operation on the AX register generates a 0 value, otherwise it is cleared.

**Repeat**                        This instruction is repeatable. If the operation follows a RPT instruction, then it will be executed N+1 times. When repeated, the "(0:16bit)" data-memory address is post-incremented by 1 during each repetition. Only the lower 16 bits of the address are affected.

```
; Copy the contents of Array1 to Array2:
; int16 Array1[N];     // Located in low 64K of data space
; int16 Array2 N];
; for(i=0; i < N; i++)
;   Array2[i] = Array1[i];
```

**Example**

```
MOVL XAR2, #Array2                ; XAR2 = pointer to Array2
RPT # (N-1)                        ; Repeat next instruction N times
| | MOV *XAR2++, *(0:Array1)       ; Array2[i] = Array1[i],
                                     ; i++
```

**MOV loc16, #0***Clear 16-bit Location*

SYNTAX OPTIONS	OPCODE	OBJMODE	RPT	CYC
MOV loc16, #0	0010 1011 LLLL LLLL	X	Y	N+1

**Operands**    **loc16**    Addressing mode (see Chapter 5)

**#0**            Immediate constant value of zero

**Description**                    Load the location pointed to by the “loc16” addressing mode with the value 0x0000:

```
[loc16] = 0x0000;
```

**Flags and Modes**    **N**            If (loc16 = @AX), then the load to AX is tested for a negative condition. The negative flag bit is set if bit 15 of AX is 1, otherwise it is cleared.

**Z**            If (loc16 = @AX), then the load to AX is tested for a zero condition. The bit is set if the result of the operation on the AX register generates a 0 value, otherwise it is cleared.

**Repeat**                            This instruction is repeatable. If the operation is followed by a RPT instruction, then it will be executed N+1 times.

**Example**                    ; Initialize the contents of Array1 with zero:  
                                   ; int16 Array1[N];  
                                   ; for(i=0; i < N; i++)  
                                   ;   Array1[i] = 0;

```

MOVL XAR2, #Array1                    ; XAR2 = pointer to Array1
RPT    #(N-1)                         ; Repeat next instruction N times
| |MOV *XAR2++, #0                    ; Array1[i] = 0,
                                          ; i++

```

**MOV loc16,ACC << 1..8***Save Low Word of Shifted Accumulator*

SYNTAX OPTIONS	OPCODE	OBJMODE	RPT	CYC
MOV loc16, ACC << 1	1011 0001 LLLL LLLL	1	Y	N+1
MOV loc16, ACC << 2..8	0101 0110 0010 1101 0000 0SHF LLLL LLLL	1	Y	N+1
	1011 1SHF LLLL LLLL	0	-	1

**Operands** loc16 Addressing mode (see Chapter 5)

ACC Accumulator register

#1..8 Shift value

**Description** Load the content of the location pointed to by the "loc16" addressing mode with the low word of the ACC register after left-shifting by the specified value. The ACC register is not modified:

```
[loc16] = ACC >> (16 - shift value); [loc16] = low (ACC <<1...8)
```

**Flags and Modes** **N** If (loc16 = @AX), then after the load AX is checked for a negative condition. The N flag is set if bit 15 of the AX is 1; else N is cleared.

**Z** If (loc16 = @AX) then after the load AX is checked for a zero condition. The Z flag is set if AX is zero; else Z is cleared.

**Repeat** If the operation is repeatable, then the instruction will be executed N+1 times. The state of the Z and N flags will reflect the final result. If the operation is not repeatable, the instruction will execute only once.

**Example**

```
; Multiply two Q15 numbers (VarA and VarB) and store result in
; VarC as a Q15 number:
MOV T,@VarA ; T = VarA (Q15)
MPY ACC,T,@VarB ; ACC = VarA * VarB (Q30)
MOVH @VarC,ACC << 1 ; VarC = ACC >> (16-1) (Q15)
; VarC as a Q31 number:
MOV T,@VarA ; T = VarA (T = Q14)
MPY ACC,T,@VarB ; ACC = VarA * VarB (ACC = Q28)
MOV @VarC+0,ACC << 3 ; VarC low = ACC << 3
MOVH @VarC+1,ACC << 3 ; VarC high = ACC >> (16-1) (VarC = Q31)
```

**MOV loc16, ARn***Store 16-bit Auxiliary Register*

SYNTAX OPTIONS	OPCODE	OBJMODE	RPT	CYC
MOV loc16, ARn	0111 1nnn LLLL LLLL	X	-	1

**Operands**    **loc16**    Addressing mode (see Chapter 5)

**ARn**        AR0 to AR7, lower 16 bits of auxiliary registers

**Description**                    Load the contents of the 16-bit location with ARn:

                                      [loc16] = ARn;

                                      If (loc16 = @ARn), then only the lower 16 bits of the selected auxiliary register is modified. The upper 16 bits is unchanged.

**Flags and Modes**    **N**            If (loc16 = @AX), then the load to AX is tested for a negative condition. Bit-15 of the AX register is the sign bit, 0 for positive, 1 for negative. The negative flag bit is set if the operation on the AX register generates a negative value, otherwise it is cleared.

**Z**            If (loc16 = @AX), then the load to AX is tested for a zero condition. The bit is set if the result of the operation on the AX register generates a 0 value, otherwise it is cleared

**Repeat**                            This instruction is not repeatable. If the operation is follows a RPT instruction, it resets the repeat counter (RPTC) and only executes once.

**Example**

```

MOV  @AL, AR3           ; Load AL with the 16-bit contents of
                        ; AR3. If bit 15 of AL is 1, set the
                        ; N flag, else clear it.
                        ; If AL is 0, set the Z flag.

MOV  @AR4, AR3          ; Load AR4 with the value in AR3.
                        ; Upper 16 bits of XAR4 are
                        ; unchanged.

MOV  *SP++, AR3         ; Push the contents of AR3 onto the
                        ; stack. Post increment SP.

MOV  *XAR4++, AR4       ; Store contents of AR4 into location
                        ; specified by XAR4. Post-increment
                        ; the contents of XAR4.

MOV  *--XAR5, AR5      ; Pre-decrement the contents of XAR5.
                        ; Store the contents of AR5 into the
                        ; location specified by XAR5.

```

**MOV loc16, AX**

Store AX

SYNTAX OPTIONS	OPCODE	OBJMODE	RPT	CYC
MOV loc16, AX	1001 011A LLLL LLLL	X	Y	N+1

**Operands**    **loc16**    Addressing mode (see Chapter 5)

**AX**        Accumulator high (AH) or accumulator low (AL) register

**Description**                    Load the addressed location pointed to by the “loc16” addressing mode with the 16-bit content of the specified AX register (AH or AL):

[loc16] = AX;

**Flags and Modes**            **N**        If (loc16 = @AX), then the load to AX is tested for a negative condition. The negative flag bit is set if bit 15 of AX is 1, otherwise it is cleared.

**Z**        If (loc16 = @AX), then the load to AX is tested for a zero condition. The bit is set if the result of the operation on the AX register generates a 0 value, otherwise it is cleared.

**Repeat**                            If this operation follows a RPT instruction, then it will be executed N+1 times. The state of the N and Z flags will reflect the final result.

**Example**                    ; Initialize all Array1 elements with the value 0xFFFF:  
MOV AH,#0xFFFF                    ; Load AH with the value 0xFFFF  
MOVL XAR2,#Array1                ; Load XAR2 with address of Array1  
RPT #9                                ; Repeat next instruction 10 times.  
|| MOV \*XAR2++, AH                ; Store contents of AH into location  
  ; pointed by XAR2 and post-increment  
  ; XAR2.

**MOV loc16, AX, COND**

*Store AX Register Conditionally*

SYNTAX OPTIONS	OPCODE	OBJMODE	RPT	CYC
MOV loc16, AX, COND	0101 0110 0010 101A 0000 COND LLLL LLLL	1	-	1

- Operands**
- loc16** Addressing mode (see Chapter 5)
  - AX** Accumulator high (AH) or accumulator low (AL) register
  - COND** Conditional codes:

COND	Syntax	Description	Flags Tested
0000	NEQ	Not Equal To	Z = 0
0001	EQ	Equal To	Z = 1
0010	GT	Greater Than	Z = 0 AND N = 0
0011	GEQ	Greater Than Or Equal To	N = 0
0100	LT	Less Than	N = 1
0101	LEQ	Less Than Or Equal To	Z = 1 OR N = 1
0110	HI	Higher	C = 1 AND Z = 0
0111	HIS, C	Higher Or Same, Carry Set	C = 1
1000	LO, NC	Lower, Carry Clear	C = 0
1001	LOS	Lower Or Same	C = 0 OR Z = 1
1010	NOV	No Overflow	V = 0
1011	OV	Overflow	V = 1
1100	NTC	Test Bit Not Set	TC = 0
1101	TC	Test Bit Set	TC = 1
1110	NBIO	BIO Input Equal To Zero	BIO = 0
1111	UNC	Unconditional	-

**Description** If the specified condition being tested is true, then the location pointed to by the "loc16" addressing mode will be loaded with the contents of the specified AX register (AH or AL):

```
if(COND = true) [loc16] = AX;
```

**Note:** Addressing modes are not conditionally executed. Hence, if an addressing mode performs a pre or post modification, the modification will occur, regardless of whether the condition is true or not.

- Flags and Modes**
- N** If (COND = true AND loc16 = @AX), AX is tested for a negative condition after the move and if bit 15 of AX is 1, the negative flag bit is set.
  - Z** If (COND = true AND loc16 = @AX), after the move, AX is tested for a zero condition and the zero flag bit is set if AX = 0, otherwise, it is cleared.
  - V** If the V flag is tested by the condition, then V is cleared.

**Repeat**                    This instruction is not repeatable. If this instruction follows the RPT instruction, it resets the repeat counter (RPTC) and executes only once.

**Example**                ; Swap the contents of VarA and VarB if VarB is higher then VarA:  
MOV AL,@VarA                    ; AL = VarA, XAR2 points to VarB  
MOV AH,@VarB                    ; AH = VarB, XAR2 points to VarA  
CMP AH,@AL                      ; Compare AH and AL  
MOV @VarA,AH,HI                 ; Store AH in VarA if higher  
MOV @VarB,AL,HI                 ; Store AL in VarB if higher



**MOV loc16,IER***Store Interrupt-Enable Register*

SYNTAX OPTIONS	OPCODE	OBJMODE	RPT	CYC
MOV loc16,IER	0010 0000 LLLL LLLL	X	-	1

**Operands**    **loc16**    Addressing mode (see Chapter 5)  
                   **IER**        Interrupt enable register

**Description**            Save the content of the IER register in the location pointed to by the "loc16" addressing mode:

[loc16] = IER;

**Flags and Modes**    **N**        If (loc16 = @AX) and bit 15 of AX is 1, then N is set; otherwise N is cleared.  
                           **Z**        If (loc16 = @AX) and the value of AX is zero, then Z is set; otherwise Z is cleared.

**Repeat**                This instruction is not repeatable. If this instruction follows the RPT instruction, it resets the repeat counter (RPTC) and executes only once.

**Example**                ; Push the contents of IER on the stack and load IER with the  
                           ; contents of VarA:  
                   MOV    \*SP++, IER                            ; Save IER on stack  
                   MOV    IER, @VarA                           ; Load IER with contents of VarA

**MOV loc16,OVC***Store the Overflow Counter*

SYNTAX OPTIONS	OPCODE	OBJMODE	RPT	CYC
MOV loc16,OVC	0101 0110 0010 1001 0000 0000 LLLL LLLL	1	-	1

**Operands**    **loc16**    Addressing mode (see Chapter 5)

**OVC**    Overflow counter

**Description**                    Store the 6 bits of the overflow counter (OVC) into the upper 6 bits of the location pointed to by the “loc16” addressing mode and zero the lower 10 bits of the addressed location:

```
[loc16(15:10)] = OVC;
[loc16(9:0)]    = 0;
```

**Flags and Modes**    **N**            If (loc16 = @AX) and bit 15 of AX is 1, then set N; otherwise clear N.

**Z**            If (loc16 = @AX) and AX is zero, then set Z; otherwise clear Z.

**Repeat**                            This instruction is not repeatable. If this instruction follows the RPT instruction, it resets the repeat counter (RPTC) and executes only once.

**Example**                            ; Save and restore contents of ACC and OVC bits:

```
MOV  *SP++,OVC                    ; Save OVC on stack
MOV  *SP++,AL                     ; Save AL on stack
MOV  *SP++,AH                     ; Save AH on stack
.
.
.
MOV  AH,*--SP                     ; Restore AH from stack
MOV  AL,*--SP                     ; Restore AL from stack
MOV  OVC,*--SP                    ; Restore OVC from stack
```

**MOV loc16,P**

*Store Lower Half of Shifted P Register*

SYNTAX OPTIONS	OPCODE	OBJMODE	RPT	CYC
MOV loc16,P	0011 1111 LLLL LLLL	X	Y	N+1

**Operands**    **loc16**    Addressing mode (see Chapter 5)  
                  **P**            Product register

**Description**            The contents of the P register are shifted by the amount specified in the product shift mode (PM), and the lower half of the shifted value is stored into the 16-bit location pointed to by the "loc16" addressing mode. The P register is not modified by the operation:

$$[\text{loc16}] = P \ll \text{PM};$$

**Flags and Modes**

**N**            If (loc16 = @AX) and bit 15 of the AX register is 1, then the N bit is set; otherwise, N is cleared.

**Z**            If (loc16 = @AX) and the value of AX after the load is zero, then the Z bit is set; otherwise Z is cleared.

**PM**           The value in the PM bits sets the shift mode for the output operation from the product register. If the product shift value is positive (logical left shift operation), then the low bits are zero filled. If the product shift value is negative (arithmetic right shift operation), the upper bits are sign extended.

**Repeat**                  This instruction is repeatable. If the operation follows a RPT instruction, then it will be executed N+1 times. The state of the Z, and N flags will reflect the final result.

**Example**

```

; Calculate Y32 = M16*X16 >> 6
MOV T,@M16                     ; T = M
MPY P,T,@X16                   ; P = T * X
SPM -6                          ; Set product shift to >> 6
MOV @Y32+0,P                   ; Y32 = P >> 6
MOVH @Y32+1,P
```

**MOV loc16, T***Store the T Register*

SYNTAX OPTIONS	OPCODE	OBJMODE	RPT	CYC
MOV, loc16, T	0010 0001 LLLL LLLL	X	-	1

<b>Operands</b>	<b>loc16</b>	Addressing mode (see Chapter 5)
	<b>T</b>	Upper 16 bits of the multiplicand register (XT)
<b>Description</b>		Store the 16-bit T register contents into the location pointed to by the "loc16" addressing mode:  [loc16] = T;
<b>Flags and Modes</b>	<b>N</b>	If (loc16 = @AX) and bit 15 of the AX register is 1, then the N bit is set; otherwise, N is cleared.
	<b>Z</b>	If (loc16 = @AX) and the value of AX after the load is zero, then the Z bit is set; otherwise Z is cleared.
<b>Repeat</b>		This instruction is not repeatable. If this instruction follows the RPT instruction, it resets the repeat counter (RPTC) and executes only once.

**Example**

```

; Calculate using 16-bit multiply:
; Y = (X0*C0) >> 2) + (X1*C1 >> 2) + (X2*C2 >> 2)
; X2 = X1
; X1 = X0
SPM -2 ; Set product shift to >> 2
MOV T,@X2 ; T = X2
MPY P,T,@C2 ; P = T*C2
MOVP T,@X1 ; T = X1, ACC = X2*C2 >> 2
MPY P,T,@C1 ; P = T*C1
MOV @X2,T ; X2 = X1
MOVA T,@X0 ; T = X0, ACC = X1*C1 >> 2 + X2*C2 >> 2
MPY P,T,@C0 ; P = T*C0
MOV @X1,T ; X1 = X0
ADDL ACC,P << PM ; ACC = X0*C0 >> 2 + X1*C1 >> 2 + X2*C2 >> 2
MOVL @Y,ACC ; Store result into Y

```

**MOV OVC, loc16**

*Load the Overflow Counter*

SYNTAX OPTIONS	OPCODE	OBJMODE	RPT	CYC
MOV OVC, loc16	0101 0110 0000 0010 0000 0000 LLLL LLLL	1	-	1

**Operands**    **OVC**    6-bit overflow counter

**Description**            Load the overflow counter (OVC) with the upper 6 bits of the location pointed to by the "loc16" addressing mode:

OVC = [loc16(15:10)];

**Flags and Modes**    **OVC**    The 6-bit overflow counter is modified.

**Repeat**                    This instruction is not repeatable. If this instruction follows the RPT instruction, it resets the repeat counter (RPTC) and executes only once.

**Example**            ; Save and restore contents of ACC and OVC bits:

```

MOV *SP++,OVC                    ; Save OVC on stack
MOV *SP++,AL                    ; Save AL on stack
MOV *SP++,AH                    ; Save AH on stack
.
.
.
MOV AH,*--SP                    ; Restore AH from stack
MOV AL,*--SP                    ; Restore AL from stack
MOV OVC,*--SP                   ; Restore OVC from stack

```

**MOV PH, loc16***Load the High Half of the P Register*

SYNTAX OPTIONS	OPCODE	OBJMODE	RPT	CYC
MOV PH, loc16	0010 1111 LLLL LLLL	X	-	1

**Operands**    **PH**        Upper 16 bits of the product register (P)  
                  **loc16**      Addressing mode (see Chapter 5)

**Description**            Load the high 16 bits of the P register (PH) with the 16-bit location pointed to by the "loc16" addressing mode; leave the lower 16 bits (PL) unchanged:

PH = [loc16];  
 PL = unchanged;

**Flags and Modes**            None

**Repeat**                    This instruction is not repeatable. If this instruction follows the RPT instruction, it resets the repeat counter (RPTC) and executes only once.

**Example**                    ; Swap the contents of AH and AL:

```
MOV  PH,@AL                    ; Load PH with AL
MOV  PL,@AH                    ; Load PL with AH
MOV  ACC,@P                    ; Load ACC with P (AH and AL swapped)
```

*MOV PL, loc16*

---

**MOV PL, loc16**

*Load the Low Half of the P Register*

SYNTAX OPTIONS	OPCODE	OBJMODE	RPT	CYC
MOVL PL, loc16	0010 0111 LLLL LLLL	X	-	1

**Operands**    **PL**        Lower 16 bits of the product register (P)  
                  **loc16**      Addressing mode (see Chapter 5)

**Description**                Load the high 16 bits of the P register (PL) with the 16-bit location pointed to by the “loc16” addressing mode; leave the lower 16 bits (PH) unchanged:  
  
                                  PL = [loc16];  
                                  PH = unchanged;

**Flags and Modes**                None

**Repeat**                        This instruction is not repeatable. If this instruction follows the RPT instruction, it resets the repeat counter (RPTC) and executes only once.

**Example**                        ; Swap the contents of AH and AL:  
                  MOV    PH, @AL    ; Load PH with AL  
                  MOV    PL, @AH    ; Load PL with AH  
                  MOV    ACC, @P    ; Load ACC with P (AH and AL swapped)

**MOV PM, AX***Load Product Shift Mode*

SYNTAX OPTIONS	OPCODE	OBJMODE	RPT	CYC
MOV PM, AX	0101 0110 0011 100A	1	-	1

**Operands**    **AX**       Accumulator high (AH) or accumulator low (AL) registers.

**Description**         Load the product shift mode (PM) bits with the 3 least significant bits of register AX.

PM = AX(2:0);

**Flags and Modes**    **PM**         The product shift mode bits are loaded with the 3 least significant bits of AX.

**Repeat**                This instruction is not repeatable. If this instruction follows the RPT instruction, it resets the repeat counter (RPTC) and executes only once.

**Example**                ; Calculate: Y32 = (M16\*X16 >> Shift) + B32, Shift = 0 to 6

```
CLRC  AMODE                             ; Make sure AMODE = 0
MOV  AL,@Shift                         ; Load AL with contents of "Shift"
ADDB AL,#1                             ; Convert "Shift" to PM encoding
MOV  PM,AX                             ; Load PM bits with encoded "Shift"
                                       value
MOV  T,@X16                             ; T = X16
MPY  P,XT,@M16                         ; P = X16*M16
MOVL ACC,@B32                         ; ACC = B32
ADDL ACC,P << PM                       ; ACC = ACC + (P >> Shift)
MOVL @Y32,ACC                         ; Store result into Y32
```



**MOV T, loc16***Load the Upper Half of the XT Register*

SYNTAX OPTIONS	OPCODE	OBJMODE	RPT	CYC
MOV T, loc16	0010 1101 LLLL LLLL	X	-	1

**Operands**    **T**            Upper 16 bits of the multiplicand register (XT)  
                   **loc16**        Addressing mode (see Chapter 5)

**Description**            Load the T register with the 16-bit contents of the location pointed to by the "loc16" addressing mode:

T = [loc16];

**Flags and Modes**            None

**Repeat**                    This instruction is not repeatable. If this instruction follows the RPT instruction, it resets the repeat counter (RPTC) and executes only once.

**Example**

```

; Calculate using 16-bit multiply:
; Y = (X0*C0) >> 2) + (X1*C1 >> 2) + (X2*C2 >> 2)
; X2 = X1
; X1 = X0
SPM    -2                                ; Set product shift to >> 2
MOV    T,@X2                            ; T = X2
MPY    P,T,@C2                         ; P = T*C2
MOVP   T,@X1                            ; T = X1, ACC = X2*C2 >> 2
MPY    P,T,@C1                         ; P = T*C1
MOV    @X2,T                            ; X2 = X1
MOVA   T,@X0                            ; T = X0, ACC = X1*C1 >> 2 + X2*C2 >> 2
MPY    P,T,@C0                         ; P = T*C0
MOV    @X1,T                            ; X1 = X0
ADDL   ACC,P << PM                     ; ACC = X0*C0 >> 2 + X1*C1 >> 2 + X2*C2 >> 2
MOVL   @Y,ACC                         ; Store result into Y

```

**MOV TL, #0***Clear the Lower Half of the XT Register*

SYNTAX OPTIONS	OPCODE	OBJMODE	RPT	CYC
MOV TL, #0	0101 0110 0101 0110	1	-	1

**Operands**    **T**        Upper 16 bits of the multiplicand register (XT)  
                  **#0**        Immediate constant value of zero

**Description**        Load the lower half of the multiplicand register (TL) with zero, leaving the upper half (T) unchanged:

TL = 0x0000;  
T = unchanged;

**Flags and Modes**        None

**Repeat**                This instruction is not repeatable. If this instruction follows the RPT instruction, it resets the repeat counter (RPTC) and executes only once.

**Example**                ; Calculate and keep low 32-bit result: Y32 = M32\*X16 >> 32  
MOV TL,#0                    ; TL = 0  
MOV T,@X16                   ; T = X16  
IMPYL P,XT,@M32             ; P = XT \* M32 (high 32-bit of result)  
MOVL @Y32,P                 ; Store result into Y32

**MOV XARn, PC**

*Save the Current Program Counter*

SYNTAX OPTIONS	OPCODE	OBJ-MODE	RPT	CYC
MOV XARn, PC	0011 1110 0101 1nnn	1	-	1

**Operands**    **XARn**    XAR0 to XAR7, 32-bit auxiliary registers  
                  **loc32**    Addressing mode (see Chapter 5)  
                  **PC**        22-bit program counter

**Description**                    Load XARn with the contents of the PC:  
                                       XARn = 0:PC;

**Flags and Modes**                None

**Repeat**                            This instruction is not repeatable. If this instruction follows the RPT instruction, it resets the repeat counter (RPTC) and executes only once.

**Example**

```

TableA:                                ; Location of TableA is relative to
.long CONST1                           ; the current program
    .long CONST2
    .long CONST3
    .
FuncA:
    MOV XAR5, PC
    SUBB XAR5, #($-TableA)              ; XAR5 = current PC location
    MOVL ACC, *+XAR5[2]                 ; XAR5 = TableA start location
    MOVL @VarA, ACC                     ; Load ACC with CONST2
                                         ; Store CONST2 in VarA
    
```

**MOVA T,loc16***Load T Register and Add Previous Product*

SYNTAX OPTIONS	OPCODE	OBJMODE	RPT	CYC
MOVA, T,loc16	0001 0000 LLLL LLLL	X	Y	N+1

<b>Operands</b>	<b>T</b>	Upper 16 bits of the multiplicand register (XT)
	<b>loc16</b>	Addressing mode (see Chapter 5)
<b>Description</b>	Load the T register with the 16-bit content of the location pointed to by the "loc16" addressing mode. Also, the content of the P register, shifted by the amount specified by the product shift mode (PM) bits, is added to the content of the ACC register:	
	$T = [loc16];$ $ACC = ACC + P \ll PM;$	
<b>Flags and Modes</b>	<b>N</b>	After the operation, if bit 31 of the ACC register is 1, the N bit is set; otherwise, N is cleared.
	<b>Z</b>	After the operation, if the value of ACC is zero, the Z bit is set; otherwise Z is cleared.
	<b>C</b>	If the addition generates a carry, then C is set; otherwise, C is cleared.
	<b>V</b>	If an overflow occurs, V is set; otherwise V is not affected
	<b>OVC</b>	If overflow mode is disabled; and if the operation generates a positive overflow, the counter is incremented. If overflow mode is disabled; and if the operation generates a negative overflow, the counter is decremented.
	<b>OVM</b>	If overflow mode bit is set; the ACC value will saturate maximum positive (0x7FFFFFFF) or maximum negative (0x80000000) if the operation overflows.
	<b>PM</b>	The value in the PM bits sets the shift mode for the output operation from the product register. If the product shift value is positive (logical left shift operation), then the low bits are zero filled. If the product shift value is negative (arithmetic right shift operation), the upper bits are sign extended.
<b>Repeat</b>	This instruction is repeatable. If the operation follows a RPT instruction, it will be executed N+1 times. The state of the Z, N, C and OVC flags reflect the final result. The V flag will be set if an intermediate overflow occurs.	

**Example**

```

; Calculate using 16-bit multiply:
; Y = (X0*C0) >> 2) + (X1*C1 >> 2) + (X2*C2 >> 2)
; X2 = X1
; X1 = X0
SPM    -2                ; Set product shift to >> 2
MOV    T,@X2             ; T = X2
MPY    P,T,@C2           ; P = T*C2
MOVP   T,@X1             ; T = X1, ACC = X2*C2 >> 2
MPY    P,T,@C1           ; P = T*C1
MOV    @X2,T             ; X2 = X1
MOVA   T,@X0             ; T = X0, ACC = X1*C1 >> 2 + X2*C2 >> 2
MPY    P,T,@C0           ; P = T*C0
MOV    @X1,T             ; X1 = X0
ADDL   ACC,P << PM      ; ACC = X0*C0 >> 2 + X1*C1 >> 2 + X2*C2 >> 2
MOVL   @Y,ACC            ; Store result into Y

```

**MOVAD T, loc16**

Load T Register

SYNTAX OPTIONS	OPCODE	OBJMODE	RPT	CYC
MOVAD T, loc16	1010 0111 LLLL LLLL	1	N	1

<b>Operands</b>	<b>T</b>	Upper 16 bits of the multiplicand register (XT)
	<b>loc16</b>	Addressing mode (see Chapter 5) <b>Note:</b> For this operation, register-addressing modes cannot be used. The modes are: @ARn, @AH, @AL, @PH, @PL, @SP, @T. An illegal instruction trap will be generated.
<b>Description</b>	Load the T register with the 16-bit content of the location pointed to by the "loc16" addressing mode and then load the next highest 16-bit location pointed to by "loc16" with the content of T. In addition, add the content of the P register, shifted by the amount specified by the product shift mode (PM) bits, to the content of the ACC register:  $T = [loc16];$ $[loc16 + 1] = T;$ $ACC = ACC + P \ll PM;$	
<b>Flags and Modes</b>	<b>N</b>	After the operation, if bit 31 of the ACC register is 1, then the N bit is set; otherwise, N is cleared.
	<b>Z</b>	After the operation, if the value of ACC is zero, then the Z bit is set; otherwise Z is cleared.
	<b>C</b>	If the addition generates a carry, the C bit is set; otherwise, C is cleared.
	<b>V</b>	If an overflow occurs, V is set; otherwise V is not affected
	<b>OVC</b>	If overflow mode is disabled; and if the operation generates a positive overflow, then the counter is incremented. If overflow mode is disabled; and if the operation generates a negative overflow, then the counter is decremented.
	<b>OVM</b>	If overflow mode bit is set; then the ACC value will saturate maximum positive (0x7FFFFFFF) or maximum negative (0x80000000) if the operation overflows.
	<b>PM</b>	The value in the PM bits sets the shift mode for the output operation from the product register. If the product shift value is positive (logical left shift operation), then the low bits are zero filled. If the product shift value is negative (arithmetic right shift operation), the upper bits are sign extended.
<b>Repeat</b>	This instruction is not repeatable. If this instruction follows the RPT instruction, it resets the repeat counter (RPTC) and executes only once.	

**Example**     ; Calculate using 16-bit multiply:  
          ; Y = (X0\*C0) >> 2) + (X1\*C1 >> 2) + (X2\*C2 >> 2)  
          ; X2 = X1  
          ; X1 = X0  
SPM     -2                     ; Set product shift to >> 2  
MOVDP   T,@X2                 ; T = X2  
MPYS    P,T,@C2               ; P = T\*C2, ACC = 0  
MOVAD   T,@X1                 ; T = X1, ACC = X2\*C2>>2, X2 = X1  
MPY     P,T,@C1               ; P = T\*C1  
MOVAD   T,@X0                 ; T = X0, ACC = X1\*C1>>2 + X2\*C2>>2, X1 = X0  
MPY     P,T,@C0               ; P = T\*C0  
ADDL    ACC,P << PM           ; ACC = X0\*C0>>2 + X1\*C1>>2 + X2\*C2>>2  
MOVL    @Y,ACC                ; Store result into Y

**MOVB ACC,#8bit**

*Load Accumulator With 8-bit Value*

SYNTAX OPTIONS	OPCODE	OBJ-MODE	RPT	CYC
MOVB ACC,#8bit	0000 0010 CCCC CCCC	1	-	1

**Operands**    **ACC**    Accumulator register  
                   **#8bit**    8-bit immediate unsigned constant value

**Description**            Load the ACC register with the specified 8-bit, zero-extended immediate constant:

ACC = 0:8bit;

**Flags and**    **N**            After the load, the N flag is set if bit 31 of the ACC is 1, else N is cleared.

**Flags and**    **Z**            After the load, the Z flag is set if the ACC value is zero, else Z is cleared.

**Repeat**                    This instruction is not repeatable. If this instruction follows the RPT instruction, it resets the repeat counter (RPTC) and executes only once.

**Example**                    ; Increment contents of 32-bit location VarA:  
 MOVb ACC,#1                    ; Load ACC with the value 0x0000 0001  
 ADDL ACC,@VarA                ; Add to ACC the contents of VarA  
 MOVL @VarA,ACC                ; Store result back into VarA



MOVB AR6/7, #8bit

---

**MOVB AR6/7, #8bit**

*Load Auxiliary Register With an 8-bit Constant*

SYNTAX OPTIONS	OPCODE	OBJMODE	RPT	CYC
MOVB AR6, #8bit	1101 0110 cccc cccc	X	-	1
MOVB AR7, #8bit	1101 0111 cccc cccc	X	-	1

**Operands**    **XARn**    XAR6 OR XAR7, 32-bit auxiliary registers  
                 **#8bit**    8-bit immediate constant value

**Description**                    Load AR6 or AR7 with an 8-bit unsigned constant and upper 16 bits of XAR6 and XAR7 are unchanged:  
  
                                      AR6/7 = 0:8bit;  
                                      AR6/7H = unchanged;

**Flags and Modes**                    None

**Repeat**                                This instruction is not repeatable. If this instruction follows the RPT instruction, it resets the repeat counter (RPTC) and executes only once

**MOVB AX, #8bit**

*Load AX With 8-bit Constant*

SYNTAX OPTIONS	OPCODE	OBJMODE	RPT	CYC
MOVB AX, #8bit	1001 101A CCCC CCCC	X	-	1

**Operands**    **AX**        Accumulator high (AH) or accumulator low (AL) register  
                   **#8bit**        8-bit immediate constant value

**Description**            Load accumulator high register (AH) or accumulator low register (AL) with an unsigned 8-bit constant zero extended, leaving the other half of the accumulator register unchanged:  
                                   AX = 0:8bit;

**Flags and Modes**        **N**            Flag always set to zero.  
                                   **Z**            The load to AX is tested for a zero condition. The bit is set if the operation results in AX = 0, otherwise it is cleared.

**Repeat**                    This instruction is not repeatable. If this instruction follows the RPT instruction, it resets the repeat counter (RPTC) and executes only once.

**Example**                  MOVB AL, #0xF0                    ; Load AL with the value 0x00F0.  
                                   CMP AL, \*+XAR0[0]                ; Compare contents pointed to by XAR0  
     ; with AL.  
                                   SB Dest, EQ                        ; Branch if values are equal.

**MOVB AX.LSB, loc16**

*Load Byte Value*

SYNTAX OPTIONS	OPCODE	OBJMODE	RPT	CYC
MOVB AX.LSB, loc16	1100 011A LLLL LLLL	X	-	1

**Operands**    **AX.LSB**    Least significant byte of accumulator high (AH.LSB) or accumulator low (AL.LSB) register

**loc16**    Addressing mode (see Chapter 5)

**Description**                    Load the least significant byte of the specified AX register (AH.LSB or AL.LSB) with 8 bits from the location pointed to by the “loc16” addressing mode. The most significant byte of AX is cleared. The form of the “loc16” operand determines which of its 8 bits are used to load AX.LSB:

```

if(loc16 = *+XARn[offset])
{
  if(offset is an even number)
    AX.LSB = [loc16.LSB];
  if(offset is an odd value)
    AX.LSB = [loc16.MSB];
}
else
  AX.LSB = [loc16.LSB];
AX.MSB = 0x00;

```

**Note:** offset = 3-bit immediate or AR0 or AR1 indexed addressing modes only.

For the following address modes, the returned result is undefined:

- \*AR6%++                            (AMODE = 0)
- \*0++                                (AMODE = x)
- \*0--                                (AMODE = x)
- \*BR0++                             (AMODE = x)
- \*BR0--                             (AMODE = x)
- \*0++, ARPn                        (AMODE = 1)
- \*0--, ARPn                        (AMODE = 1)
- \*BR0++, ARPn                     (AMODE = 1)
- \*BR0--, ARPn                     (AMODE = 1)

**Flags and Modes**    **Z**            After the move, AX is tested for a zero condition. The zero flag bit is set if AX = 0; otherwise it is cleared

**N**            After the move, AX is tested for a negative condition. The bit is set if bit 15 of AX is 1; otherwise it is cleared.

**Repeat** This instruction is not repeatable. If this instruction follows the RPT instruction, it resets the repeat counter (RPTC) and executes only once.

**Example**

```
; Swap the byte order in the 32-bit "Var32" location.
; Before operation: Var32 = B3 | B2 | B1 | B0
; After operation:  Var32 = B0 | B1 | B2 | B3
MOVL  XAR2,#Var32      ; Load XAR2 with address of "Var32"
MOVB                      ; ACC(B0) = Var32(B3), ACC(B1) = 0
AL.LSB,*+XAR2[3]
MOVB                      ; ACC(B2) = Var32(B1), ACC(B3) = 0
AH.LSB,*+XAR2[1]
MOVB                      ; ACC(B1) = Var32(B2), ACC(B1) = unch
AL.MSB,*+XAR2[2]
MOVB                      ; ACC(B3) = Var32(B0), ACC(B1) = unch
AH.MSB,*+XAR2[0]
MOVL  @Var32,ACC      ; Store swapped result in "Var32"
```

**MOVB AX.MSB, loc16**

*Load Byte Value*

SYNTAX OPTIONS	OPCODE	OBJMODE	RPT	CYC
MOVB AX.MSB, loc16	0011 100A LLLL LLLL	X	-	1

**Operands**    **AX.MSB**    Most significant byte of accumulator high (AH.MSB) or accumulator low (AL.MSB) register  
**B**  
**loc16**        Addressing mode (see Chapter 5)

**Description**        Load the most significant byte of the specified AX register (AH.MSB or AH.LSB) with 8 bits from the location pointed to by the "loc16" addressing mode. The least significant byte of AX is left unchanged. The form of the "loc16" operand determines which of its 8 bits are used to load AX.MSB

```
if (loc16 = *+XARn[offset])
{
  if (offset is an even value)
    AX.MSB = [loc16.LSB];
  if (offset is an odd value)
    AX.MSB = [loc16.MSB];
}
else
  AX.MSB = [loc16.LSB];
AX.LSB = unchanged;
```

**Note:** offset = 3-bit immediate or AR0 or AR1 indexed addressing modes only.

For the following address modes, the returned result is undefined:

- \*AR6%++                      (AMODE = 0)
- \*0++                          (AMODE = x)
- \*0--                          (AMODE = x)
- \*BR0++                        (AMODE = x)
- \*BR0--                        (AMODE = x)
- \*0++, ARPn                    (AMODE = 1)
- \*0--, ARPn                    (AMODE = 1)
- \*BR0++, ARPn                 (AMODE = 1)
- \*BR0--, ARPn                 (AMODE = 1)

**Flags and Modes**    **N**        After the move AX is tested for a negative condition. The negative flag bit is set if bit 15 of AX is 1; otherwise it is cleared.

**Z**        After the move, AX is tested for a zero condition. The zero flag bit is set if AX = 0; otherwise it is cleared.

**Repeat** This instruction is not repeatable. If this instruction follows the RPT instruction, it resets the repeat counter (RPTC) and executes only once.

**Example**

```
; Swap the byte order in the 32-bit "Var32" location.
; Before operation: Var32 = B3 | B2 | B1 | B0
; After operation:  Var32 = B0 | B1 | B2 | B3
MOVL  XAR2,#Var32      ; Load XAR2 with address of "Var32"
MOVB                      ; ACC(B0) = Var32(B3), ACC(B1) = 0
AL.LSB,*+XAR2[3]
MOVB                      ; ACC(B2) = Var32(B1), ACC(B3) = 0
AH.LSB,*+XAR2[1]
MOVB                      ; ACC(B1) = Var32(B2), ACC(B1) = unch
AL.MSB,*+XAR2[2]
MOVB                      ; ACC(B3) = Var32(B0), ACC(B1) = unch
AH.MSB,*+XAR2[0]
MOVL  @Var32,ACC      ; Store swapped result in "Var32"
```

**MOVB loc16,#8bit,COND**

*Conditionally Save 8-bit Constant*

SYNTAX OPTIONS	OPCODE	OBJMODE	RPT	CYC
MOVB loc16,#8bit,COND	0101 0110 1011 COND CCCC CCCC LLLL LLLL	1	-	1

**Operands**    **loc16**    Addressing mode (see Chapter 5)  
                  **#8bit**    8-bit immediate constant value  
                  **COND**    Conditional codes:

COND	Syntax	Description	Flags Tested
0000	NEQ	Not Equal To	Z = 0
0001	EQ	Equal To	Z = 1
0010	GT	Greater Than	Z = 0 AND N = 0
0011	GEQ	Greater Than Or Equal To	N = 0
0100	LT	Less Than	N = 1
0101	LEQ	Less Than Or Equal To	Z = 1 OR N = 1
0110	HI	Higher	C = 1 AND Z = 0
0111	HIS, C	Higher Or Same, Carry Set	C = 1
1000	LO, NC	Lower, Carry Clear	C = 0
1001	LOS	Lower Or Same	C = 0 OR Z = 1
1010	NOV	No Overflow	V = 0
1011	OV	Overflow	V = 1
1100	NTC	Test Bit Not Set	TC = 0
1101	TC	Test Bit Set	TC = 1
1110	NBIO	BIO Input Equal To Zero	BIO = 0
1111	UNC	Unconditional	-

**Description**                    If the specified condition being tested is true, then the 8-bit zero extended constant is stored in the location pointed to by the "loc16" addressing mode:

```
if(COND = true)    [loc16] = 0:8bit;
```

**Note:** Addressing modes are not conditionally executed; therefore, if an addressing mode performs a pre- or post-modification, it will execute regardless of whether the condition is true or not.

**Flags and Modes**    **N**    If (COND = true AND loc16 = @AX), then after the move AX is tested for a negative condition. The negative flag bit is set if bit 15 of AX is 1, otherwise it is cleared.

**Z**    If (COND = true AND loc16 = @AX), then after the move, AX is tested for a zero condition. The zero flag bit is set if AX = 0, otherwise it is cleared.

**V**    If the V flag is tested by the condition, then V is cleared.

**Repeat**

This instruction is not repeatable. If this instruction follows the RPT instruction, it resets the repeat counter (RPTC) and executes only once.

**Example**

```
; Calculate:
; if( VarA > 20 )
;   VarA = 0;
  CMP    @VarA,#20    ; Set flags on (VarA - 20)
  MOVB   @VarA,#0,GT  ; Zero VarA if greater then
```



**MOVB loc16, AX.LSB**

*Store LSB of AX Register*

SYNTAX OPTIONS	OPCODE	OBJMODE	RPT	CYC
MOVB loc16, AX.LSB	0011 110A LLLL LLLL	X	-	1

**Operands**    **loc16**    Addressing mode (see Chapter 5)  
                  **AX.LSB**    Least significant byte of accumulator high (AH.LSB) or accumulator low (AL.LSB) register

**Description**                    Load 8 bits of the location pointed to by the “loc16” addressing mode with the least significant byte of the specified AX register (AH.LSB or AL.LSB). The form of the “loc16” operand determines which of its 8 bits are loaded and which of its 8 bits are left unchanged:

```

if (loc16 = *+XARn[offset])
{
  if (offset is an even value)
    [loc16.LSB] = AX.LSB;
    [loc16.MSB] = unchanged;
  if (offset is an odd value)
    [loc16.LSB] = unchanged;
    [loc16.MSB] = AX.LSB;
}
else
  [loc16.LSB] = AX.LSB;
  [loc16.MSB] = unchanged;

```

**Note:** offset = 3-bit immediate or AR0 or AR1 indexed addressing modes only.

This is a read-modify-write operation.

For the following address modes, the returned result is undefined:

- \*AR6%++                            (AMODE = 0)
- \*0++                                (AMODE = x)
- \*0--                                (AMODE = x)
- \*BR0++                            (AMODE = x)
- \*BR0--                            (AMODE = x)
- \*0++, ARPn                        (AMODE = 1)
- \*0--, ARPn                        (AMODE = 1)
- \*BR0++, ARPn                    (AMODE = 1)
- \*BR0--, ARPn                    (AMODE = 1)

**Flags and Modes**    **N**            If (loc16 = @AX), then after the move AX is tested for a negative condition. The negative flag bit is set if bit 15 of AX is 1, otherwise it is cleared.  
                          **Z**            If (loc16 = @AX), then after the move, AX is tested for a zero condition. The zero flag bit is set if AX = 0, otherwise it is cleared.

**Repeat** This instruction is not repeatable. If this instruction follows the RPT instruction, it resets the repeat counter (RPTC) and executes only once.

**Example**

```
; Store the 32-bit contents of the ACC into the
; 32-bit contents of "Var32" location in reverse byte order:
; Before operation: ACC = B3 | B2 | B1 | B0
; After operation:  Var32 = B0 | B1 | B2 | B3
MOVL  XAR2,#Var32      ; Load XAR2 with address of "Var32"
MOVB                      ; Var32(B0) = ACC(B3)
*+XAR2[0],AH.MSB
MOVB                      ; Var32(B1) = ACC(B2)
*+XAR2[1],AH.LSB
MOVB                      ; Var32(B2) = ACC(B1)
*+XAR2[2],AL.MSB
MOVB                      ; Var32(B3) = ACC(B0)
*+XAR2[3],AL.LSB
```

**MOVB loc16, AX.MSB**

*Store MSB of AX Register*

SYNTAX OPTIONS	OPCODE	OBJMODE	RPT	CYC
MOVB loc16, AX.MSB	1100 100A LLLL LLLL	X	-	1

**Operands**    **loc16**    Addressing mode (see Chapter 5)

**AX.MS**    **Most significant byte of accumulator high (AH.MSB) or accumulator low**

**B**            **(AL.MSB) register**

**Description**            Load 8 bits of the location pointed to by the “loc16” addressing mode with the most significant byte of the specified AX register (AH.MSB or AL.MSB). The form of the “loc16” operand determines which of its 8 bits are loaded and which of its 8 bits are left unchanged:

```

if (loc16 = *+XARn[offset])
{
    if ( offset is an even number )
        [loc16.LSB] = AX.MSB;
        [loc16.MSB] = unchanged;
    if ( offset is an odd number )
        [loc16.LSB] = unchanged;
        [loc16.MSB] = AX.MSB;
}
else
    [loc16.LSB] = AX.MSB;
    [loc16.MSB] = unchanged;

```

**Note:** offset = 3-bit immediate or AR0 or AR1 indexed addressing modes only.

This is a read-modify-write operation.

For the following address modes, the returned result is undefined:

- \*AR6%++                    (AMODE = 0)
- \*0++                        (AMODE = x)
- \*0--                        (AMODE = x)
- \*BR0++                     (AMODE = x)
- \*BR0--                     (AMODE = x)
- \*0++, ARPn                (AMODE = 1)
- \*0--, ARPn                (AMODE = 1)
- \*BR0++, ARPn             (AMODE = 1)
- \*BR0--, ARPn             (AMODE = 1)

**Flags and Modes**    **N**    If (loc16 = @AX), then after the move AX is tested for a negative condition. The negative flag bit is set if bit 15 of AX is 1, otherwise it is cleared.

**Z**    If (loc16 = @AX), then after the move, AX is tested for a zero condition. The zero flag bit is set if AX = 0, otherwise it is cleared.

**Repeat** This instruction is not repeatable. If this instruction follows the RPT instruction, it resets the repeat counter (RPTC) and executes only once.

**Example**

```
; Store the 32-bit contents of the ACC into the
; 32-bit contents of "Var32" location in reverse byte order:
; Before operation: ACC = B3 | B2 | B1 | B0
; After operation:  Var32 = B0 | B1 | B2 | B3
MOVL  XAR2,#Var32      ; Load XAR2 with address of "Var32"
MOVB                      ; Var32(B0) = ACC(B3)
*+XAR2[0],AH.MSB
MOVB                      ; Var32(B1) = ACC(B2)
*+XAR2[1],AH.LSB
MOVB                      ; Var32(B2) = ACC(B1)
*+XAR2[2],AL.MSB
MOVB                      ; Var32(B3) = ACC(B0)
*+XAR2[3],AL.LSB
```

MOVB XARn, #8bit

---

**MOVB XARn, #8bit**

*Load Auxiliary Register With 8-bit Value*

SYNTAX OPTIONS	OPCODE	OBJMODE	RPT	CYC
MOVB XAR0...5, #8bit	1101 0nnn CCCC CCCC	X	-	1
MOVB XAR6, #8bit	1011 1110 CCCC CCCC	1	-	1
MOVB XAR7, #8bit	1011 0110 CCCC CCCC	1	-	1

**Operands**    **XARn**    XAR0 to XAR7, 32-bit auxiliary registers  
                  **#8bit**    8-bit immediate constant value

**Description**                    Load XARn with the 8-bit unsigned immediate value:  
                                      XARn = 0:8bit;

**Flags and Modes**                None

**Repeat**                            This instruction is not repeatable. If this instruction follows the RPT instruction, it resets the repeat counter (RPTC) and executes only once.

**Example**                    MOVb    XAR0, #F2h                    ; Load XAR0 with 0x0000 00F2

**MOVDL XT,loc32**

*Store XT and Load New XT*

SYNTAX OPTIONS	OPCODE	OBJMODE	RPT	CYC
MOVDL XT,loc32	1010 0110 LLLL LLLL	1	Y	N+1

**Operands**    **XT**        Multiplicand register

**loc32**      Addressing mode (see Chapter 5)

**Note:** For this operation, register-addressing modes cannot be used. The modes are: @XARn, @ACC, @P, @XT. An illegal instruction trap will be generated.

**Description**                    Load the XT register with the 32-bit content of the location pointed to by the “loc32” addressing mode and then load the next highest 32-bit location pointed to by “loc32” with the content of XT:

```

XT = [loc32];
[loc32 + 2] = XT;

```

**Flags and Modes**                    None

**Repeat**                            This instruction is repeatable. If this instruction follows the RPT instruction, then it will be executed N+1 times.

**Example**                    ; Calculate using 32-bit multiply, retaining high result:  
; Y = (X0\*C0 >> 2) + (X1\*C1 >> 2) + (X2\*C2 >> 2)  
; X2 = X1  
; X1 = X0

```

SPM     -2                    ; Set product shift to >> 2
ZAPA                         ; Zero ACC, P, OVC
MOVL    XT,@X2              ; XT = X2
QMPYAL  P,XT,@C2            ; P = XT*C2
MOVDL   XT,@X1              ; XT = X1, X2 = X1
QMPYAL  P,XT,@C1            ; P = XT*C1, ACC = X2*C2>>2
MOVDL   XT,@X0              ; XT = X0, X1 = X0
QMPYAL  P,XT,@C0            ; P = XT*C0, ACC = X1*C1>>2 + X2*C2>>2
ADDL    ACC,P << PM        ; ACC = X0*C0>>2 + X1*C1>>2 + X2*C2>>2
MOVL    @Y,ACC              ; Store result into Y

```

MOVH loc16,ACC << 1..8

**MOVH loc16,ACC << 1..8**

*Save High Word of Shifted Accumulator*

SYNTAX OPTIONS	OPCODE	OBJMODE	RPT	CYC
MOVH loc16, ACC << 1	1011 0011 LLLL LLLL	1	Y	N+1
MOVH loc16, ACC << 2..8	0101 0110 0010 1111 0000 0SHF LLLL LLLL	1	Y	N+1
	1011 0SHF LLLL LLLL	0	-	1

**Operands**    **loc16**    Addressing mode (see Chapter 5)  
                   **ACC**        Accumulator register  
                   **#1..8**        Shift value

**Description**                    Load the content of the location pointed to by the "loc16" addressing mode with the high word of the ACC register after left-shifting by the specified value. The ACC register is not modified:  
     [loc16] = ACC >> (16 - shift value);

**Flags and Modes**    **N**            If (loc16 = @AX), then after the load AX is checked for a negative condition. The N flag is set if bit 15 of the AX is 1; else N is cleared.  
     **Z**            If (loc16 = @AX) then after the load AX is checked for a zero condition. The Z flag is set if AX is zero; else Z is cleared.

**Repeat**                            If the operation is repeatable, then the instruction will be executed N+1 times. The state of the Z and N flags will reflect the final result. If the operation is not repeatable, the instruction will execute only once.

**Example**                            ; Multiply two Q15 numbers (VarA and VarB) and store result in  
     ; VarC as a Q15 number:  
 MOV    T,@VarA                    ; T = VarA                            (Q15)  
 MPY    ACC,T,@VarB               ; ACC = VarA \* VarB               (Q30)  
 MOVH   @VarC,ACC << 1           ; VarC = ACC >> (16-1) (Q15)  
     ; VarC as a Q31 number:  
 MOV    T,@VarA                    ; T = VarA                            (T = Q14)  
 MPY    ACC,T,@VarB               ; ACC = VarA \* VarB               (ACC = Q28)  
 MOV    @VarC+0,ACC <<           ; VarC low    = ACC << 3  
     3  
 MOVH   @VarC+1,ACC <<           ; VarC high   = ACC >> (16-1) (VarC = Q31)  
     3

**MOVH loc16, P***Save High Word of the P Register*

SYNTAX OPTIONS	OPCODE	OBJMODE	RPT	CYC
MOVH loc16,P	0101 0111 LLLL LLLL	X	Y	N+1

**Operands**    **loc16**    Addressing mode (see Chapter 5)  
                   **P**            Product register

**Description**            The contents of the P register are shifted by the amount specified in the product shift mode (PM), and the upper half of the shifted value is stored into the 16-bit location pointed to by the "loc16" addressing mode. The P register is not modified by the operation:

$$[\text{loc16}] = (\text{P} \ll \text{PM}) \gg 16;$$

**Flags and Modes**    **N**            If (loc16 = @AX) and bit 15 of the AX register is 1, then the N bit is set; otherwise, N is cleared.  
                           **Z**            If (loc16 = @AX) and the value of AX after the load is zero, then the Z bit is set; otherwise Z is cleared.  
                           **PM**          The value in the PM bits sets the shift mode for the output operation from the product register. If the product shift value is positive (logical left shift operation), then the low bits are zero filled. If the product shift value is negative (arithmetic right shift operation), the upper bits are sign extended.

**Repeat**                This instruction is repeatable. If the operation follows a RPT instruction, then it will be executed N+1 times. The state of the Z, and N flags will reflect the final result.

**Example**                ; Calculate Y32 = M16\*X16 >> 6  
 MOV    T,@M16                    ; T = M  
 MPY    P,T,@X16                 ; P = T \* X  
 SPM    -6                         ; Set product shift to >> 6  
 MOV    @Y32+0,P                 ; Y32 = P >> 6  
 MOVH   @Y32+1,P



**MOVL ACC,loc32**

*Load Accumulator With 32 Bits*

SYNTAX OPTIONS	OPCODE	OBJMODE	RPT	CYC
MOVL ACC,loc32	0000 0110 LLLL LLLL	X	-	1

**Operands**    **ACC**    **Accumulator register**  
                   **loc32**    **Addressing mode (see Chapter 5)**

**Description**                    Load the ACC register with the content of the location pointed to by the "loc32" addressing mode.  
                                       ACC = [loc32];

**Flags and Modes**            **N**            **After the load, the N flag is set if bit 31 of the ACC is 1, else N is cleared.**  
                                       **Z**            **After the load, the Z flag is set if the ACC is zero, else Z is cleared.**

**Repeat**                        This instruction is not repeatable. If this instruction follows the RPT instruction, it resets the repeat counter (RPTC) and executes only once.

**Example**                      Calculate the 32-bit value: VarC = VarA + VarB;  
                                       MOVL ACC,@VarA                ; Load ACC with contents of VarA  
                                       ADDL ACC,@VarB                ; Add to ACC the contents of VarB  
                                       MOVL @VarC,ACC                ; Store result into VarC

**MOVL ACC,P << PM**

*Load the Accumulator With Shifted P*

SYNTAX OPTIONS	OPCODE	OBJMODE	RPT	CYC
MOVL ACC,P << PM	0001 0110 1010 1100	X	-	1

**Note:** This instruction is an alias for the "MOVP T,loc16" operation with "loc16 = @T" addressing mode.

**Operands**

**ACC** Accumulator register

**P** Product register

**<< PM** Product shift mode

**Description** Load the ACC register with the content of the P register shifted as specified by the product shift mode (PM):

$$ACC = P \ll PM;$$

**Flags and Modes**

**N** After the load, the N flag is set if bit 31 of the ACC is 1, else N is cleared.

**Z** After the load, the Z flag is set if the ACC is zero, else Z is cleared.

**PM** The value in the PM bits sets the shift mode for the output operation from the product register. If the product shift value is positive (logical left shift operation), then the low bits are zero filled. If the product shift value is negative (arithmetic right shift operation), the upper bits are sign extended.

**Repeat** This instruction is not repeatable. If this instruction follows the RPT instruction, it resets the repeat counter (RPTC) and executes only once.

**Example**

```

; Calculate: Y = Y + (M*X >> 4)
; Y is a 32-bit value, M and X are 16-bit values
SPM    -4                ; Set product shift to >> 4
MOV    T,@M              ; T = M
MPY    P,T,@X            ; P = M * X
MOVL   ACC,P << PM       ; ACC = M*X >> 4
ADDL   @Y,ACC            ; Y = Y + ACC
    
```

MOVL loc32, ACC

---

**MOVL loc32, ACC**

*Store 32-bit Accumulator*

SYNTAX OPTIONS	OPCODE	OBJMODE	RPT	CYC
MOVL loc32, ACC	0001 1110 LLLL LLLL	X	-	1

**Operands**    **ACC**    Accumulator register  
                 **loc32**    Addressing mode (see Chapter 5)

**Description**                    Store the contents of the ACC register into the location pointed to by the "loc32" addressing mode:  
  
                                      [loc32] = ACC;

**Flags and Modes**    **N**            If (loc32 = @ACC) then after the load, the N flag is set if bit 31 of the ACC is 1, else N is cleared.  
  
                                      **Z**            If (loc32 = @ACC) then after the load, the Z flag is set if ACC is zero, else Z is cleared.

**Repeat**                            This instruction is not repeatable. If this instruction follows the RPT instruction, it resets the repeat counter (RPTC) and executes only once.

**Example**                            Calculate the 32-bit value: VarC = VarA + VarB;  
MOVL ACC,@VarA                    ; Load ACC with contents of VarA  
ADDL ACC,@VarB                    ; Add to ACC the contents of VarB  
MOVL @VarC,ACC                    ; Store result into VarC

**MOVL loc32,ACC,COND**

*Conditionally Store the Accumulator*

SYNTAX OPTIONS	OPCODE	OBJMODE	RPT	CYC
MOVL loc32,ACC,COND	0101 0110 0100 1000 0000 COND LLLL LLLL	X	-	1

**Operands**    **loc32**    Addressing mode (see Chapter 5)

**ACC**        Accumulator register

**COND**    Conditional codes:

COND	Syntax	Description	Flags Tested
0000	NEQ	Not Equal To	Z = 0
0001	EQ	Equal To	Z = 1
0010	GT	Greater Than	Z = 0 AND N = 0
0011	GEQ	Greater Than Or Equal To	N = 0
0100	LT	Less Than	N = 1
0101	LEQ	Less Than Or Equal To	Z = 1 OR N = 1
0110	HI	Higher	C = 1 AND Z = 0
0111	HIS, C	Higher Or Same, Carry Set	C = 1
1000	LO, NC	Lower, Carry Clear	C = 0
1001	LOS	Lower Or Same	C = 0 OR Z = 1
1010	NOV	No Overflow	V = 0
1011	OV	Overflow	V = 1
1100	NTC	Test Bit Not Set	TC = 0
1101	TC	Test Bit Set	TC = 1
1110	NBIO	BIO Input Equal To Zero	BIO = 0
1111	UNC	Unconditional	-

**Description**

If the specified condition being tested is true, then the location pointed to by the "loc32" addressing mode will be loaded with the contents of the ACC register:

```
if(COND = true) [loc32] = ACC;
```

**Note:** Addressing modes are not conditionally executed. Hence, if an addressing mode performs a pre or post modification, the modification will occur regardless of whether the condition is true or not.

**Flags and Modes**

<b>N</b>	If (COND = true AND loc32 = @ACC), then after the move if bit 31 of ACC is 1, N is set; otherwise N cleared.
<b>Z</b>	If (COND = true AND loc32 = @ACC), then after the move if (ACC = 0), then the Z bit is set; otherwise it is cleared.
<b>V</b>	If the V flag is tested by the condition, then V is cleared.

**Repeat** This instruction is not repeatable. If this instruction follows the RPT instruction, it resets the repeat counter (RPTC) and executes only once.

**Example** ; Swap the contents of 32-bit VarA and VarB if VarB is higher:

```
MOVL ACC,@VarB ; ACC = VarB
MOVL P,@VarA ; P = VarA
CMPL ACC,@P ; Set flags on (VarB - VarA)
MOVL @VarA,ACC,HI ; VarA = ACC if higher
MOVL @P,ACC,HI ; P = ACC if higher
MOVL @VarA,P ; VarA = P
```

**MOVL loc32,P**

*Store the P Register*

SYNTAX OPTIONS	OPCODE	OBJMODE	RPT	CYC
MOVL loc32,P	1010 1001 LLLL LLLL	1	-	1

**Operands**    **loc32**    Addressing mode (see Chapter 5)  
                   **P**            Product register

**Description**            Store the P register contents into the location pointed to by the "loc32" addressing mode:  
                               [loc32] = P;

**Flags and Modes**    **N**            If (loc32 = @ACC) and bit 31 of the ACC register is 1, then the N bit is set; otherwise, N is cleared.  
                               **Z**            If (loc32 = @ACC) and the value of ACC after the load is zero, then the Z bit is set; otherwise Z is cleared.

**Repeat**                This instruction is not repeatable. If this instruction follows the RPT instruction, it resets the repeat counter (RPTC) and executes only once.

**Example**                ; Add 64-bit VarA, VarB and VarC, and store result in VarD:  
                   MOVL P,@VarA+0            ; Load P with low 32 bits of VarA  
                   MOVL ACC,@VarA+2        ; Load ACC with high 32 bits of VarA  
                   ADDUL P,@VarB+0         ; Add to P unsigned low 32 bits of VarB  
                   ADDCL ACC,@VarB+2       ; Add to ACC with carry high 32 bits of VarB  
                   ADDUL P,@VarC+0         ; Add to P unsigned low 32 bits of VarC  
                   ADDCL ACC,@VarC+2       ; Add to ACC with carry high 32 bits of VarC  
                   MOVL @VarD+0,P         ; Store low 32-bit result into VarD  
                   MOVL @VarD+2,ACC       ; Store high 32-bit result into VarD

**MOVL *loc32*, XARn**

*Store 32-bit Auxiliary Register*

SYNTAX OPTIONS	OPCODE	OBJMODE	RPT	CYC
MOVL <i>loc32</i> , XAR0	0011 1010 LLLL LLLL	1	–	1
MOVL <i>loc32</i> , XAR1	1011 0010 LLLL LLLL	1	–	1
MOVL <i>loc32</i> , XAR2	1010 1010 LLLL LLLL	1	–	1
MOVL <i>loc32</i> , XAR3	1010 0010 LLLL LLLL	1	–	1
MOVL <i>loc32</i> , XAR4	1010 1000 LLLL LLLL	1	–	1
MOVL <i>loc32</i> , XAR5	1010 0000 LLLL LLLL	1	–	1
MOVL <i>loc32</i> , XAR6	1100 0010 LLLL LLLL	X	–	1
MOVL <i>loc32</i> , XAR7	1100 0011 LLLL LLLL	X	–	1

**Operands**    **loc32**    Addressing mode (see Chapter 5)  
                   **XARn**    XAR0 to XAR7, 32-bit auxiliary registers

**Description**                    Load the contents of the 32-bit addressed location with the contents of XARn:

[*loc32*] = XARn;

**Flags and Modes**    **N**            If (*loc32* = @ACC), then the load to ACC is tested for a negative condition. Bit-31 of the ACC register is the sign bit, 0 for positive, 1 for negative. The negative flag bit is set if the operation on the ACC register generates a negative value, otherwise it is cleared.

**Z**            If (*loc32* = @ACC), then the load to ACC is tested for a zero condition. The bit is set if the result of the operation on the ACC register generates a 0 value, otherwise it is cleared

**Repeat**                            This instruction is not repeatable. If this instruction follows the RPT instruction, it resets the repeat counter (RPTC) and executes only once.

**Example**

```

MOVL  @ACC, XAR0      ; Move the 32-bit contents of XAR0 into ACC.
                       ; If bit 31 of the ACC is 1 set N. If
                       ; ACC = 0, set Z.
MOVL  *XAR1, XAR7     ; Move the 32-bit contents of XAR7 into the
                       ; location pointed to by XAR1.
MOVL  *XAR6++,XAR6    ; Move the 32-bit contents of XAR6 into the
                       ; location pointed to by XAR6. Post-increment
                       ; the contents of XAR6.
MOVL  *--XAR5,XAR5    ; Predecrement the contents of XAR5. Move the
                       ; 32-bit contents of XAR5 into the location
                       ; pointed to by ; XAR5.
    
```

**MOVL loc32,XT**

*Store the XT Register*

SYNTAX OPTIONS	OPCODE	OBJMODE	RPT	CYC
MOVL loc32,XT	1010 1011 LLLL LLLL	1	-	1

**Operands**    **loc32**    Addressing mode (see Chapter 5)  
                   **XT**        Multiplicand register

**Description**                    Store the XT register into 32-bit location pointed to by the “loc32” addressing mode:  
   [loc32] = XT;

**Flags and Modes**    **N**        If (loc32 = @ACC) and bit 31 of the ACC register is 1, then the N bit is set; otherwise, N is cleared.  
                                   **Z**        If (loc32 = @ACC) and the value of ACC after the load is zero, then the Z bit is set; otherwise Z is cleared.

**Repeat**                            This instruction is not repeatable. If this instruction follows the RPT instruction, it resets the repeat counter (RPTC) and executes only once.

**Example**                            ; Calculate using 32-bit multiply, retaining high result:  
                                   ; Y = (X0\*C0) >> 2) + (X1\*C1 >> 2) + (X2\*C2 >> 2)  
                                   ; X2 = X1  
                                   ; X1 = X0  
 SPM                            -2                            ; Set product shift to >> 2  
 ZAPA    ; Zero ACC, P, OVC  
 MOVL                            XT,@X2                            ; XT = X2  
 QMPYL                            P,XT,@C2                            ; P = XT\*C2  
 MOVL                            XT,@X1                            ; XT = X1, ACC = X2\*C2 >> 2  
 QMPYAL                            P,XT,@C1                            ; P = XT\*C1  
 MOVL                            @X2,XT                            ; X2 = X1  
 MOVL                            XT,@X0                            ; XT = X0, ACC = X1\*C1 >> 2 + X2\*C2 >> 2  
 QMPYAL                            P,XT,@C0                            ; P = XT\*C0  
 MOVL                            @X1,XT                            ; X1 = X0  
 ADDL                            ACC,P << PM                            ; ACC = X0\*C0 >> 2 + X1\*C1 >> 2 + X2\*C2 >> 2  
 MOVL                            @Y,ACC                            ; Store result into Y



MOVL P,ACC

---

**MOVL P,ACC**

*Load P From the Accumulator*

SYNTAX OPTIONS	OPCODE	OBJMODE	RPT	CYC
MOVL P,ACC	1111 1111 0101 1010	X	-	1

**Operands**    **P**        Product register  
                 **ACC**      Accumulator register

**Description**            Load the P register with the content of the ACC register:  
                              P = ACC;

**Flags and Modes**            None

**Repeat**                    This instruction is not repeatable. If this instruction follows the RPT instruction, it resets the repeat counter (RPTC) and executes only once.

**Example**                    Calculate the 32-bit value: VarC = abs(VarA) + abs(VarB)

```
MOVL  ACC,@VarA           ; Load ACC with contents of VarA
ABS   ACC                 ; Take absolute value of VarA
MOVL  P,ACC               ; Temp save ACC in P register
MOVL  ACC,@VarB          ; Load ACC with contents of VarB
ABS   ACC                 ; Take absolute value of VarB
ADDL  ACC,@P              ; Add contents of P to ACC
MOVL  @VarC,ACC          ; Store result into VarC
```

**MOVL P,loc32**

*Load the P Register*

SYNTAX OPTIONS	OPCODE	OBJMODE	RPT	CYC
MOVL P,loc32	1010 0011 LLLL LLLL	1	-	1

**Operands**    **P**            Product register  
                  **loc32**        Addressing mode (see Chapter 5)

**Description**            Load the P register with the 32-bit location pointed to by the "loc32" addressing mode:

P = [loc32];

**Flags and Modes**            None

**Repeat**                    This instruction is not repeatable. If this instruction follows the RPT instruction, it resets the repeat counter (RPTC) and executes only once.

**Example**                    ; Add 64-bit VarA, VarB and VarC, and store result in VarD:  
 MOVL P,@VarA+0            ; Load P with low 32 bits of VarA  
 MOVL ACC,@VarA+2         ; Load ACC with high 32 bits of VarA  
 ADDUL P,@VarB+0          ; Add to P unsigned low 32 bits of VarB  
 ADDCL ACC,@VarB+2        ; Add to ACC with carry high 32 bits of VarB  
 ADDUL P,@VarC+0          ; Add to P unsigned low 32 bits of VarC  
 ADDCL ACC,@VarC+2        ; Add to ACC with carry high 32 bits of VarC  
 MOVL @VarD+0,P            ; Store low 32-bit result into VarD  
 MOVL @VarD+2,ACC         ; Store high 32-bit result into VarD

**MOVL XARn, loc32**

*Load 32-bit Auxiliary Register*

SYNTAX OPTIONS	OPCODE	OBJMODE	RPT	CYC
MOVL XAR0, loc32	1000 1110 LLLL LLLL	1	–	1
MOVL XAR1, loc32	1000 1011 LLLL LLLL	1	–	1
MOVL XAR2, loc32	1000 0110 LLLL LLLL	1	–	1
MOVL XAR3, loc32	1000 0010 LLLL LLLL	1	–	1
MOVL XAR4, loc32	1000 1010 LLLL LLLL	1	–	1
MOVL XAR5, loc32	1000 0011 LLLL LLLL	1	–	1
MOVL XAR6, loc32	1100 0100 LLLL LLLL	X	–	1
MOVL XAR7, loc32	1100 0101 LLLL LLLL	X	–	1

**Operands**    **XARn**    XAR0 to XAR7, 32-bit auxiliary registers  
                   **loc32**    Addressing mode (see Chapter 5)

**Description**                    Load XARn with the contents of the 32-bit addressed location:  
   XARn = [loc32];

**Flags and Modes**                None

**Repeat**                            This instruction is not repeatable. If this instruction follows the RPT instruction, it resets the repeat counter (RPTC) and executes only once.

**Example**

```

MOVL  XAR0, @ACC      ; Move the 32-bit contents of ACC into
                       ; XAR0
MOVL  XAR2, *XAR0++   ; Move the 32-bit value pointed to by
                       ; XAR0 into XAR2. Post increment XAR0
                       ; by 2
MOVL  XAR3, *XAR3++   ; Move the 32-bit value pointed to by
                       ; XAR3 into XAR3. Address modification
                       ; of XAR3 is ignored.
MOVL  XAR4, *--XAR4   ; Predecrement the contents of XAR4.
                       ; Move the 32-bit value pointed to by
                       ; XAR4 into XAR4.
    
```



**MOVL XT,loc32**

*Load the XT Register*

SYNTAX OPTIONS	OPCODE	OBJMODE	RPT	CYC
MOVL XT, loc32	1000 0111 LLLL LLLL	1	-	1

**Operands**    **T**        Upper 16 bits of the multiplicand register (XT)  
                  **loc32**      Addressing mode (see Chapter 5)

**Description**            Load the XT register with the 32-bit content of the location pointed to by the "loc32" addressing mode:

```
XT = [loc32];
```

**Flags and Modes**            None

**Repeat**                    This instruction is not repeatable. If this instruction follows the RPT instruction, it resets the repeat counter (RPTC) and executes only once.

```
Example            ; Calculate using 32-bit multiply, retaining high result:
                 ; Y = (X0*C0 >> 2) + (X1*C1 >> 2) + (X2*C2 >> 2)
                 ; X2 = X1
                 ; X1 = X0
SPM            -2                    ; Set product shift to >> 2
ZAPA                                ; Zero ACC, P, OVC
MOVL          XT,@X2                ; XT = X2
QMPYL        P,XT,@C2               ; P = XT*C2
MOVL          XT,@X1                ; XT = X1, ACC = X2*C2 >> 2
QMPYAL       P,XT,@C1               ; P = XT*C1
MOVL          @X2,XT                ; X2 = X1
MOVL          XT,@X0                ; XT = X0, ACC = X1*C1 >> 2 + X2*C2 >> 2
QMPYAL       P,XT,@C0               ; P = XT*C0
MOVL          @X1,XT                ; X1 = X0
ADDL          ACC,P << PM           ; ACC = X0*C0 >> 2 + X1*C1 >> 2 + X2*C2 >> 2
MOVL          @Y,ACC                ; Store result into Y
```

**MOVP T,loc16***Load the T Register and Store P in the Accumulator*

SYNTAX OPTIONS	OPCODE	OBJMODE	RPT	CYC
MOVP T,loc16	0001 0110 LLLL LLLL	X	-	1

**Operands**    **T**        Upper 16 bits of the multiplicand register (XT)  
                   **loc16**    Addressing mode (see Chapter 5)

**Description**        Load the T register with the 16-bit content of the location pointed to by the “loc16” addressing mode. Also, the content of the P register, shifted by the amount specified by the product shift mode (PM) bits, is loaded into the ACC register:

```
T = [loc16];
ACC = P << PM;
```

**Flags and Modes**    **N**        After the operation if bit 31 of the ACC register is 1, then the N bit is set; otherwise, N is cleared.  
                           **Z**        After the operation, if the value of ACC is zero, then the Z bit is set; otherwise Z is cleared.  
                           **PM**       The value in the PM bits sets the shift mode for the output operation from the product register. If the product shift value is positive (logical left shift operation), then the low bits are zero filled. If the product shift value is negative (arithmetic right shift operation), the upper bits are sign extended.

**Repeat**                This instruction is not repeatable. If this instruction follows the RPT instruction, it resets the repeat counter (RPTC) and executes only once.

**Example**                ; Calculate using 16-bit multiply:  
                           ; Y = (X0\*C0 >> 2) + (X1\*C1 >> 2) + (X2\*C2 >> 2)  
                           ; X2 = X1  
                           ; X1 = X0

```
SPM     -2                    ; Set product shift to >> 2
MOV     T,@X2                ; T = X2
MPY     P,T,@C2              ; P = T*C2
MOVP    T,@X1                ; T = X1, ACC = X2*C2 >> 2
MPY     P,T,@C1              ; P = T*C1
MOV     @X2,T                ; X2 = X1
MOVA    T,@X0                ; T = X0, ACC = X1*C1 >> 2 + X2*C2 >> 2
MPY     P,T,@C0              ; P = T*C0
MOV     @X1,T                ; X1 = X0
ADDL    ACC,P << PM         ; ACC = X0*C0 >> 2 + X1*C1 >> 2 + X2*C2 >> 2
MOVL    @Y,ACC              ; Store result into Y
```

**MOVS T,loc16**

*Load T and Subtract P From the Accumulator*

SYNTAX OPTIONS	OPCODE	OBJMODE	RPT	CYC
MOVS, T,loc16	0001 0001 LLLL LLLL	X	Y	N+1

**Operands**    **T**            Upper 16 bits of the multiplicand register (XT)  
                   **loc16**        Addressing mode (see Chapter 5)

**Description**            Load the T register with the 16-bit content of the location pointed to by the “loc16” addressing mode. Also, the content of the P register, shifted by the amount specified by the product shift mode (PM) bits, is subtracted from the content of the ACC register:

$$T = [\text{loc16}];$$

$$\text{ACC} = \text{ACC} - P \ll \text{PM};$$

**Flags and Modes**    **N**            After the operation, if bit 31 of the ACC register is 1, then the N bit is set; otherwise, N is cleared.

**Z**            After the operation, if the value of ACC is zero, then the Z bit is set; otherwise Z is cleared.

**C**            If the subtraction generates a borrow, the C bit is cleared; otherwise, C is set.

**V**            If an overflow occurs, V is set; otherwise V is not affected

**OVC**        If overflow mode is disabled; and if the operation generates a positive overflow, then the counter is incremented. If overflow mode is disabled; and if the operation generates a negative overflow, then the counter is decremented.

**OVM**        If overflow mode bit is set; then the ACC value will saturate maximum positive (0x7FFFFFFF) or maximum negative (0x80000000) if the operation overflows.

**PM**         The value in the PM bits sets the shift mode for the output operation from the product register. If the product shift value is positive (logical left shift operation), then the low bits are zero filled. If the product shift value is negative (arithmetic right shift operation), the upper bits are sign extended.

**Repeat**                    This instruction is repeatable. If the operation follows a RPT instruction, then it will be executed N+1 times. The state of the Z, N, C and OVC flags will reflect the final result. The V flag will be set if an intermediate overflow occurs.

**Example** ; Calculate using 16-bit multiply:  
; Y = (X0\*C0) >> 2) + (X1\*C1 >> 2) + (X2\*C2 >> 2)  
; X2 = X1  
; X1 = X0  
SPM -2 ; Set product shift to >> 2  
MOVP T,@X2 ; T = X2  
MPYS P,T,@C2 ; P = T\*C2, ACC = 0  
MOVS T,@X1 ; T = X1, ACC = -X2\*C2 >> 2  
MPY P,T,@C1 ; P = T\*C1  
MOV @X2,T ; X2 = X1  
MOVA T,@X0 ; T = X0, ACC = -X1\*C1 >> 2 - X2\*C2 >> 2  
MPY P,T,@C0 ; P = T\*C0  
MOV @X1,T ; X1 = X0  
SUBL ACC,P << PM ; ACC = -X0\*C0 >> 2 - X1\*C1 >> 2 - X2\*C2 >> 2  
MOVL @Y,ACC ; Store result into Y



**MOVU ACC,loc16**

*Load Accumulator With Unsigned Word*

SYNTAX OPTIONS	OPCODE	OBJ-MODE	RPT	CYC
MOVU ACC,loc16	0000 1110 LLLL LLLL	X	-	1

**Operands**    **ACC**    Accumulator register  
                  **loc16**    Addressing mode (see Chapter 5)

**Description**                    Load the low half of the accumulator (AL) with the 16-bit contents of the addressed location pointed to by the “loc16” addressing mode and fill the high half of the accumulator (AH) with 0s:

```
AL = [loc16];
AH = 0x0000;
```

**Flags and Modes**    **N**            Clear flag.  
                          **Z**            After the load, the Z flag is set if the ACC value is zero, else Z is cleared.

**Repeat**                            This instruction is not repeatable. If this instruction follows the RPT instruction, it resets the repeat counter (RPTC) and executes only once.

**Example**                            ; Add three 32-bit unsigned variables by 16-bit parts:  
 MOVU ACC,@VarAlow            ; AH = 0, AL = VarAlow  
 ADD ACC,@VarAhigh            ; AH = VarAhigh, AL = VarAlow  
 << 16  
 ADDU ACC,@VarBlow            ; ACC = ACC + 0:VarBlow  
 ADD ACC,@VarBhigh            ; ACC = ACC + VarBhigh << 16  
 << 16  
 ADDCU ACC,@VarClow           ; ACC = ACC + VarClow + Carry  
 ADD ACC,@VarChigh            ; ACC = ACC + VarChigh << 16  
 << 16

**MOVU loc16,OVC***Store the Unsigned Overflow Counter*

SYNTAX OPTIONS	OPCODE	OBJMODE	RPT	CYC
MOVU loc16,OVC	0101 0110 0010 1000 0000 0000 LLLL LLLL	1	-	1

**Operands**    **loc16**    Addressing mode (see Chapter 5)  
                  **OVC**        Overflow counter

**Description**            Store the 6 bits of the overflow counter (OVC) into the lower 6 bits of the location pointed to by the "loc16" addressing mode and zero the upper 10 bits of the addressed location:

```
[loc16(15:6)] = 0;
[loc16(5:0)]  = OVC;
```

**Flags and Modes**    **N**        If (loc16 = @AX) and bit 15 of AX is 1, then set N; otherwise clear N.

**Z**        If (loc16 = @AX) and AX is zero, then set Z; otherwise clear Z.

**Repeat**                This instruction is not repeatable. If this instruction follows the RPT instruction, it resets the repeat counter (RPTC) and executes only once.

**Example**                ; Save and restore contents of ACC and OVC bits:

```
MOVU  *SP++,OVC          ; Save OVC on stack
MOV   *SP++,AL           ; Save AL on stack
MOV   *SP++,AH           ; Save AH on stack
.
.
.
MOV   AH,*--SP           ; Restore AH from stack
MOV   AL,*--SP           ; Restore AL from stack
MOVU  OVC,*--SP         ; Restore OVC from stack
```

**MOVU OVC,loc16**

*Load Overflow Counter With Unsigned Value*

SYNTAX OPTIONS	OPCODE	OBJMODE	RPT	CYC
MOVU OVC,loc16	0101 0110 0110 0010 0000 0000 LLLL LLLL	1	-	1

**Operands**    **OVC**    6-bit overflow counter

**Description**                    Load the overflow counter (OVC) with the lower 6 bits of the location pointed to by the "loc16" addressing mode:

$$OVC = [loc16(5:0)]$$

**Flags and Modes**    **OVC**    The 6-bit overflow counter is modified.

**Repeat**                            This instruction is not repeatable. If this instruction follows the RPT instruction, it resets the repeat counter (RPTC) and executes only once.

**Example**                    ; Save and restore contents of ACC and OVC bits:

```

MOVU  *SP++,OVC           ; Save OVC on stack
MOV   *SP++,AL            ; Save AL on stack
MOV   *SP++,AH            ; Save AH on stack
.
.
.
.
MOV   AH,*--SP            ; Restore AH from stack
MOV   AL,*--SP            ; Restore AL from stack
MOVU  OVC,*--SP           ; Restore OVC from stack

```



**MOVX TL,loc16***Load Lower Half of XT With Sign Extension*

SYNTAX OPTIONS	OPCODE	OBJMODE	RPT	CYC
MOVX TL,loc16	0101 0110 0010 0001 xxxx xxxx LLLL LLLL	1	-	1

**Operands**    **TL**        Lower 16 bits of the multiplicand register (XT)

**loc16**      Addressing mode (see Chapter 5)

**Description**            Load the lower 16 bits of the multiplicand register (TL) with the 16-bit contents of the location pointed to by the "loc16" addressing mode and then sign extend that value into the upper upper 16 bits of XT:

TL = [loc16];  
T = sign extension of TL;

**Flags and Modes**            None

**Repeat**                      This instruction is not repeatable. If this instruction follows the RPT instruction, it resets the repeat counter (RPTC) and executes only once.

**Example**                    ; Calculate and keep low 32-bit result: Y32 = M32\*X16

```
MOVX  TL,@X16           ; XT = S:X16
IMPYL P,XT,@M32        ; P = XT * M32 (low 32 bits of result)
MOVL  @Y32,P           ; Store result into Y32
```

**MOVZ ARn, loc16***Load Lower Half of XARn and Clear Upper Half*

SYNTAX OPTIONS	OPCODE	OBJ-MODE	RPT	CYC
MOVZ AR0...5, loc16	0101 1nnn LLLL LLLL	X	–	1
MOVZ AR6, loc16	1000 1000 LLLL LLLL	1	–	1
MOVZ AR7, loc16	1000 0000 LLLL LLLL	1	–	1

**Operands**    **ARn**    AR0 to AR7, lower 16 bits of auxiliary registers  
                   **loc16**    Addressing modes (See chapter 5)

**Description**            Load ARn with the contents of the 16-bit location and clear ARnH:

```
ARn = [loc16];
ARnH = 0;
```

**Flags and Modes**            None

**Repeat**                    This instruction is not repeatable. If this instruction follows the RPT instruction, it resets the repeat counter (RPTC) and executes only once.

**Example**

```
MOVL XAR7, #ArrayA            ; Initialize XAR2 pointer
MOVZ AR0, *+XAR2[0]           ; Load 16-bit value pointed to by XAR2
                                 ; into AR0. XAR0(31:16) = 0.
MOVZ AR7, *-SP[1]             ; Load the first 16-bit value off of the
                                 ; stack into AR7. XAR7(31:16) = 0.
```



**MPY ACC,loc16, #16bit**

16 X 16-bit Multiply

SYNTAX OPTIONS	OPCODE	OBJMODE	RPT	CYC
MPY ACC, loc16,#16bit	0011 0100 LLLL LLLL CCCC CCCC CCCC CCCC	X	-	1

<b>Operands</b>	<b>ACC</b>	<b>Accumulator register</b>
	<b>loc16</b>	Addressing mode (see Chapter 5) 16-bit immediate constant value
<b>Description</b>		Load the T register with the 16-bit content of the location pointed to by the "loc16" addressing mode; then, multiply the signed 16-bit content of the T register by the specified signed 16-bit constant value:  T = [loc16]; ACC = signed T * signed 16bit;
<b>Flags and Modes</b>	<b>Z</b>	After the operation, the Z flag is set if the ACC is zero, else Z is cleared.
	<b>N</b>	After the operation, the N flag is set if bit 31 of the ACC is 1, else N is cleared.
<b>Repeat</b>		This instruction is not repeatable. If this instruction follows the RPT instruction, it resets the repeat counter (RPTC) and executes only once.
<b>Example</b>		<pre> ; Calculate signed using 16-bit multiply: ; Y32 = Y32 + X16 * 2000 MPY   ACC,@X16,#2000      ; T = X16, ACC = X16 * 2000 ADDL  @Y32,ACC            ; Y32 = Y32 + ACC </pre>



**MPY ACC, T, loc16**

16 X 16-bit Multiply

SYNTAX OPTIONS	OPCODE	OBJMODE	RPT	CYC
MPY ACC,T,loc16	0001 0010 LLLL LLLL	X	-	1

**Operands**

**ACC** Accumulator register

**T** Multiplicand register

**loc16** Addressing mode (see Chapter 5)

**Description** Multiply the signed 16-bit content of the T register by the signed 16-bit contents of the location pointed to by the "loc16" addressing mode and store the result in the ACC register:

$ACC = \text{signed } T * \text{signed } [loc16];$

**Flags and Modes**

**Z** After the operation, the Z flag is set if the ACC is zero, else Z is cleared.

**N** After the operation, the N flag is set if bit 31 of the ACC is 1, else N is cleared.

**Repeat** This instruction is not repeatable. If this instruction follows the RPT instruction, it resets the repeat counter (RPTC) and executes only once.

**Example**

```
; Calculate signed using 16-bit multiply:
; Y32 = Y32 + X16*M16
MOV    T,@X16          ; T = X16
MPY    ACC,T,@M16      ; ACC = T * M16
ADDL   @Y32,ACC        ; Y32 = Y32 + ACC
```

**MPY P,loc16,#16bit**

16 X 16-Bit Multiply

SYNTAX OPTIONS	OPCODE	OBJMODE	RPT	CYC
MPY P,loc16,#16bit	1000 1100 LLLL LLLL CCCC CCCC CCCC CCCC	1	-	1

**Operands**

**P** Product register

**loc16** Addressing mode (see Chapter 5)

**#16bit** 16-bit immediate constant value

**Description**

Multiply the signed 16-bit contents of the location pointed to by the "loc16" addressing mode by the 16-bit immediate value and store the 32-bit result in the P register:

$$P = \text{signed} [\text{loc16}] * \text{signed } 16\text{bit};$$

**Flags and Modes**

None

**Repeat**

This instruction is not repeatable. If this instruction follows the RPT instruction, it resets the repeat counter (RPTC) and executes only once.

**Example**

```

; ; Calculate using 16-bit multiply:
; Y = (X0*C0 >> 2) + (X1*C1 >> 2) + (X2*C2 >> 2),
; C0, C1 and C2 are constants
SPM    -2                ; Set product shift to >> 2
MOVB   ACC,#0           ; Zero ACC
MPY    P,@X2,#C2        ; P = X2*C2
MPYA   P,@X1,#C1        ; ACC = X2*C2>>2, P = X1*C1
MPYA   P,@X0,#C0        ; ACC = X1*C1>>2 + X2*C2>>2, P = X0*C0
ADDL   ACC,P << PM      ; ACC = X0*C0>>2 + X1*C1>>2 + X2*C2>>2
MOVL   @Y,ACC           ; Store result into Y

```

**MPY P,T,loc16**

16 X 16 Multiply

SYNTAX OPTIONS	OPCODE	OBJMODE	RPT	CYC
MPY P,T,loc16	0011 0011 LLLL LLLL	X	-	1

**Operands**

**P** Product register

**T** Multiplicand register

**loc16** Addressing mode (see Chapter 5)

**Description**

Multiply the signed 16-bit content of the T register by the signed 16-bit contents of the location pointed to by the "loc16" addressing mode and store the 32-bit result in the P register:

$P = \text{signed } T * \text{signed } [\text{loc16}];$

**Flags and Modes**

None

**Repeat**

This instruction is not repeatable. If this instruction follows the RPT instruction, it resets the repeat counter (RPTC) and executes only once.

**Example**

```

; Calculate using 16-bit multiply:
; Y = (X0*C0 >> 2) + (X1*C1 >> 2) + (X2*C2 >> 2)
; X2 = X1
; X1 = X0

SPM    -2                ; Set product shift to >> 2
MOVP   T,@X2             ; T = X2
MPYS   P,T,@C2           ; P = T*C2, ACC = 0
MOVAD  T,@X1             ; T = X1, ACC = X2*C2>>2, X2 = X1
MPY    P,T,@C1           ; P = T*C1
MOVAD  T,@X0             ; T = X0, ACC = X1*C1>>2 + X2*C2>>2, X1 = X0
MPY    P,T,@C0           ; P = T*C0
ADDL   ACC,P << PM      ; ACC = X0*C0>>2 + X1*C1>>2 + X2*C2>>2
MOVL   @Y,ACC            ; Store result into Y

```

**MPYA P,loc16,#16bit***16 X 16-Bit Multiply and Add Previous Product*

SYNTAX OPTIONS	OPCODE	OBJMODE	RPT	CYC
MPYA P,loc16,#16bit	0001 0101 LLLL LLLL CCCC CCCC CCCC CCCC	X	-	1

**Operands**

**P** Product register

**loc16** Addressing mode (see Chapter 5)

**#16bit** 16-bit immediate constant value

**Description**

Add the previous product (stored in the P register), shifted as specified by the product shift mode (PM) bits, to the ACC register. Load the T register with the content of the location pointed to by the “loc16” addressing mode. Multiply the signed 16-bit content of the T register by the signed 16-bit constant value and store the 32-bit result in the P register:

```
ACC = ACC + P << PM;
T = [loc16];
P = signed T * signed 16bit;
```

**Flags and Modes**

**Z** After the operation, the Z flag is set if the ACC is zero, else Z is cleared.

**N** After the addition, the N flag is set if bit 31 of the ACC is 1, else N is cleared.

**C** If the addition generates a carry, C is set; otherwise C is cleared.

**V** If an overflow occurs, V is set; otherwise V is not affected.

**OVC** If overflow mode is disabled; and if the operation generates a positive overflow, then the counter is incremented. If overflow mode is disabled; and if the operation generates a negative overflow, then the counter is decremented.

**OVM** If overflow mode bit is set; then the ACC value will saturate maximum positive (0x7FFFFFFF) or maximum negative (0x80000000) if the operation overflowed.

**PM** The value in the PM bits sets the shift mode for the output operation from the product register. If the product shift value is positive (logical left shift operation), then the low bits are zero filled. If the product shift value is negative (arithmetic right shift operation), the upper bits are sign extended.

**Repeat**

This instruction is not repeatable. If this instruction follows the RPT instruction, it resets the repeat counter (RPTC) and executes only once.

**Example** ; Calculate using 16-bit multiply:  
;  $Y = (X0 * C0) \gg 2) + (X1 * C1 \gg 2) + (X2 * C2 \gg 2)$ ,  
; C0, C1 and C2 are constants  
SPM -2 ; Set product shift to  $\gg 2$   
MOVB ACC,#0 ; Zero ACC  
MPY P,@X2,#C2 ; P = X2\*C2  
MPYA P,@X1,#C1 ; ACC = X2\*C2 $\gg 2$ , P = X1\*C1  
MPYA P,@X0,#C0 ; ACC = X1\*C1 $\gg 2$  + X2\*C2 $\gg 2$ , P = X0\*C0  
ADDL ACC,P << PM ; ACC = X0\*C0 $\gg 2$  + X1\*C1 $\gg 2$  + X2\*C2 $\gg 2$   
MOVL @Y,ACC ; Store result into Y

**MPYA P,T,loc16***16 X 16-bit Multiply and Add Previous Product*

SYNTAX OPTIONS	OPCODE	OBJMODE	RPT	CYC
MPYA P,T,loc16	0001 0111 LLLL LLLL	X	Y	N+1

**Operands**

**P** Product register

**T** Multiplicand register

**loc16** Addressing mode (see Chapter 5)

**Description**

Add the previous product (stored in the P register), shifted as specified by the product shift mode (PM), to the ACC register. Multiply the signed 16-bit content of T by the signed 16-bit content of the location pointed to by the "loc16" addressing mode and store the 32-bit result in the P register:

$$\text{ACC} = \text{ACC} + \text{P} \ll \text{PM};$$

$$\text{P} = \text{signed T} * \text{signed} [\text{loc16}];$$

**Flags and Modes**

**Z** After the operation, the Z flag is set if the ACC is zero, else Z is cleared.

**N** After the addition, the N flag is set if bit 31 of the ACC is 1, else N is cleared.

**C** If the addition generates a carry, C is set; otherwise C is cleared.

**V** If an overflow occurs, V is set; otherwise V is not affected.

**OVC** If overflow mode is disabled; and if the operation generates a positive overflow, then the counter is incremented. If overflow mode is disabled; and if the operation generates a negative overflow, then the counter is decremented.

**OVM** If overflow mode bit is set; then the ACC value will saturate maximum positive (0x7FFFFFFF) or maximum negative (0x80000000) if the operation overflowed.

**PM** The value in the PM bits sets the shift mode for the output operation from the product register. If the product shift value is positive (logical left shift operation), then the low bits are zero filled. If the product shift value is negative (arithmetic right shift operation), the upper bits are sign extended.

**Repeat**

This instruction is repeatable. If the operation follows a RPT instruction, then it will be executed N+1 times. The state of the Z, N, C and OVC flags will reflect the final result. The V flag will be set if an intermediate overflow occurs.

**Example** ; Calculate using 16-bit multiply:  
; Y = (X0\*C0) >> 2) + (X1\*C1 >> 2) + (X2\*C2 >> 2)  
SPM -2 ; Set product shift to >> 2  
MOVP T,@X2 ; ACC = P, T = X2  
MPYS P,T,@C2 ; ACC = ACC - P = 0, P = T\*C2  
MOV T,@X1 ; T = X1  
MPYA P,T,@C1 ; ACC = X2\*C2>>2, P = T\*C1  
MOV T,@X0 ; T = X0  
MPYA P,T,@C0 ; ACC = X1\*C1>>2 + X2\*C2>>2, P = T\*C0  
ADDL ACC,P << PM ; ACC = X0\*C0>>2 + X1\*C1>>2 + X2\*C2>>2  
MOVL @Y,ACC ; Store result into Y

**MPYB ACC,T,#8bit***Multiply by 8-bit Constant*

SYNTAX OPTIONS	OPCODE	OBJMODE	RPT	CYC
MPYB ACC,T,#8bit	0011 0101 CCCC CCCC	X	-	1

**Operands**

**ACC** Accumulator register

**T** Multiplicand register

**#8bit** 8-bit immediate constant value

**Description** Multiply the signed 16-bit content of the T register by the unsigned 8-bit constant value zero extended and store the result in the ACC register:

$$ACC = \text{signed } T * 0:8\text{bit}$$

**Flags and Modes**

**Z** After the operation, the Z flag is set if the ACC is zero, else Z is cleared.

**N** After the operation, the N flag is set if bit 31 of the ACC is 1, else N is cleared.

**Repeat** This instruction is not repeatable. If this instruction follows the RPT instruction, it resets the repeat counter (RPTC) and executes only once.

**Example**

```

; Calculate signed using 16-bit multiply:
; Y32 = Y32 + (X16 * 5)
MOV    T,@X16          ; T = X16
MPYB   ACC,T,#5        ; ACC = T * 5
ADDL   @Y32,ACC        ; Y32 = Y32 + ACC

```



MPYB P,T,#8bit

---

**MPYB P,T,#8bit**

*Multiply Signed Value by Unsigned 8-bit Constant*

SYNTAX OPTIONS	OPCODE	OBJMODE	RPT	CYC
MPYB P,T,#8bit	0011 0001 cccc cccc	X	-	1

**Operands**

<b>P</b>	Product register
<b>T</b>	Multiplicand register
<b>#8bit</b>	8-bit immediate constant value

**Description** Multiply the signed 16-bit content of the T register by the unsigned 8-bit immediate constant value zero extended and store the 32-bit result in the P register:

$P = \text{signed } T * 0:8\text{bit};$

**Flags and Modes** None

**Repeat** This instruction is not repeatable. If this instruction follows the RPT instruction, it resets the repeat counter (RPTC) and executes only once.

**Example**

```
; Calculate: Y32 = X16 * 5;
MOV    T,@X16          ; T = X16
MPYB   P,T,#5          ; P = T * #5
MOVL   @Y,P            ; Store result into Y32
```

**MPYS P,T,loc16***16 X 16-bit Multiply and Subtract*

SYNTAX OPTIONS	OPCODE	OBJMODE	RPT	CYC
MPYS P,T,loc16	0001 0011 LLLL LLLL	X	Y	N+1

**Operands**

**P** Product register

**T** Multiplicand register

**loc16** Addressing mode (see Chapter 5)

**Description**

Subtract the previous product (stored in the P register), shifted as specified by the product shift mode (PM), from the ACC register. In addition, multiply the signed 16-bit content of the T register by the signed 16-bit constant value and store the result in the P register:

$$\text{ACC} = \text{ACC} - \text{P} \ll \text{PM};$$

$$\text{P} = \text{signed T} * \text{signed [loc16]};$$

**Flags and Modes**

**Z** After the operation, the Z flag is set if the ACC is zero, else Z is cleared.

**N** After the subtraction, the N flag is set if bit 31 of the ACC is 1, else N is cleared.

**C** If the subtraction generates a carry, C is set; otherwise C is cleared.

**V** If an overflow occurs, V is set; otherwise V is not affected.

**OVC** If overflow mode is disabled; and if the operation generates a positive overflow, then the counter is incremented. If overflow mode is disabled; and if the operation generates a negative overflow, then the counter is decremented.

**OVM** If overflow mode bit is set; then the ACC value will saturate maximum positive (0x7FFFFFFF) or maximum negative (0x80000000) if the operation overflowed.

**PM** The value in the PM bits sets the shift mode for the output operation from the product register. If the product shift value is positive (logical left shift operation), then the low bits are zero filled. If the product shift value is negative (arithmetic right shift operation), the upper bits are sign extended.

**Repeat**

This instruction is repeatable. If the operation follows a RPT instruction, then it will be executed N+1 times. The state of the Z, N, C and OVC flags will reflect the final result. The V flag will be set if an intermediate overflow occurs.

**Example** ; Calculate using 16-bit multiply:  
; Y = (X0\*C0) >> 2) + (X1\*C1 >> 2) + (X2\*C2 >> 2)  
SPM -2 ; Set product shift to >> 2  
MOVP T,@X2 ; ACC = P, T = X2  
MPYS P,T,@C2 ; ACC = ACC - P = 0, P = T\*C2  
MOV T,@X1 ; T = X1  
MPYA P,T,@C1 ; ACC = X2\*C2>>2, P = T\*C1  
MOV T,@X0 ; T = X0  
MPYA P,T,@C0 ; ACC = X1\*C1>>2 + X2\*C2>>2, P = T\*C0  
ADDL ACC,P << PM ; ACC = X0\*C0>>2 + X1\*C1>>2 + X2\*C2>>2  
MOVL @Y,ACC ; Store result into Y

**MPYU P,T,loc16***Unsigned 16 X 16 Multiply*

SYNTAX OPTIONS	OPCODE	OBJMODE	RPT	CYC
MPYU P,T,loc16	0011 0111 LLLL LLLL	X	-	1

**Operands**

**P** Product register

**T** Multiplicand register

**loc16** Addressing mode (see Chapter 5)

**Description** Multiply the signed 16-bit content of the T register by the signed 16-bit contents of the location pointed to by the "loc16" addressing mode and store the 32-bit result in the P register:

$P = \text{unsigned } T * \text{unsigned } [\text{loc16}];$

**Flags and Modes** None

**Repeat** This instruction is not repeatable. If this instruction follows the RPT instruction, it resets the repeat counter (RPTC) and executes only once.

**Example**

```

; Calculate unsigned value: Y32 = X16 * M16;
MOV    T,@X16          ; T = X16
MPYU   P,T,@M16        ; P = T * M16
MOVL   @Y,P            ; Store result into Y32

```

**MPYU ACC,T,loc16***16 X 16-bit Unsigned Multiply*

SYNTAX OPTIONS	OPCODE	OBJMODE	RPT	CYC
MPYU ACC,T,loc16	0011 0110 LLLL LLLL	X	-	1

**Operands**

**ACC** Accumulator register

**T** Multiplicand register

**loc16** Addressing mode (see Chapter 5)

**Description**

Multiply the unsigned 16-bit content of the T register by the unsigned 16-bit content of the location pointed to by the "loc16" addressing mode and store the 32-bit results in the ACC register:

$$\text{ACC} = \text{unsigned T} * \text{unsigned [loc16]};$$

**Flags and Modes**

**Z** After the operation, the Z flag is set if the ACC is zero, else Z is cleared.

**N** After the operation, the N flag is set if bit 31 of the ACC is 1, else N is cleared.

**Repeat**

This instruction is not repeatable. If this instruction follows the RPT instruction, it resets the repeat counter (RPTC) and executes only once.

**Example**

```
; Calculate unsigned using 16-bit multiply:
; Y32 = Y32 + X16*M16
MOV    T,@X16          ; T = X16
MPYU   ACC,T,@M16      ; ACC = T * M16
ADDL   @Y32,ACC        ; Y32 = Y32 + ACC
```

**MPYXU ACC, T, loc16***Multiply Signed Value by Unsigned Value*

SYNTAX OPTIONS		OBJMODE	RPT	CYC
MPYXU ACC, T, loc16	0011 0000 LLLL LLLL	X	-	1

**Operands**

**ACC** Accumulator register

**T** Multiplicand register

**loc16** Addressing mode (see Chapter 5)

**Description** Multiply the signed 16-bit content of the T register by the unsigned 16-bit content of the location pointed to by the "loc16" addressing mode and store the result in the ACC register:

$ACC = \text{signed } T * \text{unsigned } [loc16];$

**Flags and Modes**

**Z** After the operation, the Z flag is set if the ACC is zero, else Z is cleared.

**N** After the operation, the N flag is set if bit 31 of the ACC is 1, else N is cleared.

**Repeat** This instruction is not repeatable. If this instruction follows the RPT instruction, it resets the repeat counter (RPTC) and executes only once.

**Example**

```
; Calculate signed using 16-bit multiply:
; Y32 = Y32 + (signed) X16 * (unsigned) M16
MOV    T,@X16           ; T = X16
MPYXU  ACC,T,@M16       ; ACC = T * M16
ADDL   @Y32,ACC         ; Y32 = Y32 + ACC
```

**MPYXU P,T,loc16**

*Multiply Signed Value by Unsigned Value*

SYNTAX OPTIONS	OPCODE	OBJMODE	RPT	CYC
MPYXU P,T,loc16	0011 0010 LLLL LLLL	X	-	1

**Operands**

**P** Product register

**T** Multiplicand register

**loc16** Addressing mode (see Chapter 5)

**Description**

Multiply the signed 16-bit content of the T register by the signed 16-bit contents of the location pointed to by the "loc16" addressing mode and store the 32-bit result in the P register:

$$P = \text{signed } T * \text{unsigned } [\text{loc16}];$$

**Flags and Modes**

None

**Repeat**

This instruction is not repeatable. If this instruction follows the RPT instruction, it resets the repeat counter (RPTC) and executes only once.

**Example** ; Calculate "Y32 = X32 \* M32" by parts using 16-bit multiply:

```

MOV    T,@X32+0      ; T = unsigned low X32
MPYU   ACC,T,@M32+0  ; ACC = T * unsigned low M32
MOV    @Y32+0,AL     ; Store low result into Y32
MOVU   ACC,@AH       ; Logical shift right ACC by 16
MOV    T,@X32+1      ; T = signed high X32
MPYXU  P,T,@M32+0    ; ACC = T * low unsigned M32
MOVA   T,@M32+1      ; T = signed high M32, ACC += P
MPYXU  P,T,@X32+0    ; ACC = T * low unsigned X32
ADDL   ACC,@P        ; Add P to ACC
MOV    @Y32+1,AL     ; Store high result into Y32
    
```

**NASP**

*Unalign Stack Pointer*

SYNTAX OPTIONS	OPCODE	OBJMODE	RPT	CYC
NASP	0111 0110 0001 0111	X	-	1

**Operands**            None

**Description**            If the SPA bit is 1, the NASP instruction decrements the stack pointer (SP) by 1 and then clears the SPA status bit. This undoes a stack pointer alignment performed earlier by the ASP instruction. If the SPA bit is 0, then the NASP instruction performs no operation.

```

if( SPA = 1 )
{
    SP = SP - 1;
    SPA = 0;
}
    
```

**Flags and Modes**    **SPA**    If (SPA = 1), then SPA is cleared.

**Repeat**                    This instruction is not repeatable. If this instruction follows the RPT instruction, it resets the repeat counter (RPTC) and executes only once.

**Example**            ; Alignment of stack pointer in interrupt service routine:  
                      ; Vector table:  
 INTx: .long INTx-            ; INTx interrupt vector  
 Service  
                      .  
                      .  
 INTxService:  
                      ASP                                    ; Align stack pointer  
                      .  
                      .  
                      .  
                      NASP                                    ; Re-align stack pointer  
                      IRET                                    ; Return from interrupt.



**NEG ACC***Negate Accumulator*

SYNTAX OPTIONS	OPCODE	OBJMODE	RPT	CYC
NEG ACC	1111 1111 0101 0100	X	-	1

**Operands**    **ACC**    Accumulator register

**Description**            Negate the contents of the ACC register:

```

if(ACC = 0x8000 0000)
{
    V = 1;
    if(OVM = 1)
        ACC = 0x7FFF FFFF;
    else
        ACC = 0x8000 0000;
}
else
    ACC = -ACC;
if(ACC = 0x0000 0000)
    C = 1;
else
    C = 0;

```

**Flags and Modes**    **N**            After the operation, the N flag is set if bit 31 of the ACC is 1, else N is cleared.

**Z**            After the operation, the Z flag is set if the ACC is zero, else Z is cleared.

**C**            If (ACC = 0), set C; otherwise, clear C.

**V**            If (ACC = 0x8000 0000) at the start of the operation, this is considered an overflow value and V is set. Otherwise, V is not affected.

**OVM**        If (ACC = 0x8000 0000) at the start of the operation, this is considered an overflow value, and the ACC value after the operation depends on the state of OVM: If OVM is cleared, ACC will be filled with 0x8000 0000. If OVM is set ACC will be saturated to 0x7FFF FFFF.

**Repeat**            This instruction is not repeatable. If this instruction follows the RPT instruction, it resets the repeat counter (RPTC) and executes only once.

**Example**            ; Negate contents of VarA, make sure value is saturated:

```

MOVL    ACC,@VarA        ; Load ACC with contents of VarA
SETC    OVM              ; Turn overflow mode on
NEG     ACC              ; Negate ACC and saturate
MOVL    @VarA,ACC        ; Store result into VarA

```

**NEG AX***Negate AX Register*

SYNTAX OPTIONS	OPCODE	OBJMODE	RPT	CYC
NEG AX	1111 1111 0101 110A	X	-	1

**Operands**    **AX**    Accumulator high (AH) or accumulator low (AL) register

**Description**            Replace the contents of the specified AX register with the negative of AX:

```

if(AX = 0x8000)
{
    AX = 0x8000;
    V flag = 1;
}
else
    AX = -AX;
if(AX = 0x0000)
    C flag = 1;
else
    C flag = 0;

```

**Flags and Modes**    **N**    After the operation, if bit 15 of AX is 1, then the negative flag bit is set; otherwise, it is cleared.

**Z**    After the operation, if AX is 0, then the Z bit is set, otherwise it is cleared.

**C**    If AX is 0, C is set; otherwise, it is cleared.

**V**    If AX is 0x8000 at the start of the operation, then this is considered an overflow and V is set. Otherwise V is not affected.

**Repeat**                    This instruction is not repeatable. If this instruction follows the RPT instruction, it resets the repeat counter (RPTC) and executes only once.

**Example**                ; Take the absolute value of VarA:

```

MOV    AL,@VarA      ; Load AL with contents of VarA
NEG    AL            ; If Al = 8000h, then V = 1
SB     NoOver-      ; Branch and save -AL if no overflow
flow,NOV
MOV    @VarA,0x7FFFh ; Save 7FFF if overflow
NoOverflow:
MOV    @VarA,AL     ; Save NEG AL if no overflow

```

**NEG64 ACC:P***Negate Accumulator Register and Product Register*

SYNTAX OPTIONS	OPCODE	OBJMODE	RPT	CYC
NEG64 ACC:P	0101 0110 0101 1000	1	-	1

**Operands**    **ACC:P**    Accumulator register (ACC) and product register (P)

**Description**                    Negate the 64-bit content of the combined ACC:P registers:

```

if(ACC:P = 0x8000 0000 0000 0000)
{
  V = 1;
  if(OVM = 1)
    ACC:P = 0x7FFF FFFF FFFF FFFF;
  else
    ACC:P = 0x8000 0000 0000 0000;
}
else
  ACC:P = -ACC:P;
if(ACC:P = 0x0000 0000 0000 0000)
  C = 1;
else
  C = 0;

```

**Flags and Mode**    **N**            After the shift, if bit 31 of the ACC register is 1 then ACC:P is negative and the N bit is set; otherwise N is cleared.

**Z**            After the operation, the Z flag is set if the combined 64-bit value of the ACC:P is zero; otherwise, Z is cleared.

**C**            If (ACC:P = 0) then the C bit is set; otherwise C is cleared.

**V**            if(ACC:P = 0x8000 0000 0000 0000) then the V flag is set; otherwise, V is not modified.

**OVM**        If at the start of the operation, ACC:P = 0x8000 0000 0000 0000, then this is considered an overflow value and the ACC:P value after the operation depends on OVM. If (OVM = 1) ACC:P is filled with its greatest positive number (0x7FFF FFFF FFFF FFFF). If (OVM = 0) then ACC:P is not modified.

**Repeat**                            This instruction is not repeatable. If this instruction follows the RPT instruction, it resets the repeat counter (RPTC) and executes only once.

**Example** ; Negate the contents of the 64-bit Var64 and saturate:  
MOVL ACC,@Var64+2 ; Load ACC with high 32-bits of Var64  
MOVL P,@Var64+0 ; Load P with low 32-bits of Var64  
SETC OVM ; Enable overflow mode (saturate)  
NEG64 ACC:P ; Negate ACC:P with saturation  
MOVL @Var64+2,ACC ; Store high 32-bit result into Var64  
MOVL @Var64+0,P ; Store low 32-bit result into Var64

**NEGTC ACC***If TC is Equivalent to 1, Negate ACC*

SYNTAX OPTIONS	OPCODE	OBJMODE	RPT	CYC
NEGTC ACC	0101 0110 0011 0010	1	-	1

**Operands**    **ACC**    Accumulator register

**Description**                      Based on the state of the test control (TC) bit, conditionally replace the content of the ACC register with its negative:

```

if( TC = 1 )
{
  if(ACC = 0x8000 0000)
  {
    V = 1;
    if(OVM = 1)
      ACC = 0x7FFF FFFF;
    else
      ACC = 0x8000 0000
  }
  else
    ACC = -ACC;
  if(ACC = 0x0000 0000)
    C = 1;
  else
    C = 0;
}

```

**Flags and Modes**

**N**            After the operation, the N flag is set if bit 31 of the ACC is 1, else N is cleared.

**Z**            After the operation, the Z flag is set if the ACC is zero, else Z is cleared.

**C**            If (TC = 1 AND ACC = 0) set C; if (TC = 1 AND ACC != 0) clear C; otherwise C is not modified.

**V**            If (TC = 1 AND ACC = 0x8000 0000) at the start of the operation, this is considered an overflow value and V is set. Otherwise, V is not affected.

**TC**            The state of the TC bit is used as a test condition for the operation.

**OVM**            If at the start of the operation, ACC = 0x8000 0000, then this is considered an overflow value and the ACC value after the operation depends on OVM. If OVM is cleared and TC = 1, ACC will be filled with 0x8000 0000. If OVM is set and TC = 1, ACC will be saturated to 0x7FFF FFFF.

**Repeat**                              This instruction is not repeatable. If this instruction follows the RPT instruction, it resets the repeat counter (RPTC) and executes only once.

**Example** ; Calculate signed: Quot16 = Num16/Den16, Rem16 = Num16%Den16

```
CLRC    TC                ; Clear TC flag, used as sign flag
MOV     ACC,@Den16 << 16  ; AH = Den16, AL = 0
ABSTC   ACC                ; Take abs value, TC = sign ^ TC
MOV     T,@AH              ; Temp save Den16 in T register
MOV     ACC,@Num16 << 16  ; AH = Num16, AL = 0
ABSTC   ACC                ; Take abs value, TC = sign ^ TC
MOVU    ACC,@AH            ; AH = 0, AL = Num16
RPT     #15                ; Repeat operation 16 times
| |SUBCU @T                ; Conditional subtract with Den16
MOV     @Rem16,AH          ; Store remainder in Rem16
MOV     ACC,@AL << 16     ; AH = Quot16, AL = 0
NEGTC   ACC                ; Negate if TC = 1
MOV     @Quot16,AH        ; Store quotient in Quot16
```

**NOP *{\*ind}*{AR*Pn*}**

*No Operation With Optional Indirect Address Modification*

SYNTAX OPTIONS	OPCODE	OBJMODE	RPT	CYC
NOP <i>{*ind}</i> {,AR <i>Pn</i> }	0111 0111 LLLL LLLL	X	Y	N+1

**Operands**    *{\*ind}*    Indirect address mode (see chapter 5)  
                   AR*Pn*    Auxiliary register pointer (ARP0 to ARP7)

**Description**                    Modify the indirect address operand as specified and change the auxiliary register pointer (ARP) to the given auxiliary register. If no operands are given, then do nothing.

**Flags and Modes**                None

**Repeat**                            This instruction is repeatable. If this instruction follows the RPT instruction, it will execute N+1 times.

**Example**

```

; Copy the contents of Array1 to Array2:
; int32 Array1[N];
; int32 Array2[N];
; for(i=0; i < N; i++)
; Array2[i] = Array1[i];
; This example only works for code located in upper 64K
; of program space:
MOVL  XAR2,#Array1      ; XAR2 = pointer to Array1
MOVL  XAR3,#Array2      ; XAR3 = pointer to Array2
MOV   @AR0,#(N-1)       ; Repeat loop N times
NOP   *,ARP2            ; Point to XAR2 (ARP = 2)
SETC  AMODE             ; Full C2xLP address mode compatible
Loop:
MOVL  ACC,*             ; ACC = Array1[i]
NOP   **+,ARP3         ; Increment XAR2 and point to XAR3
RPT   #19              ; Do nothing for 20 cycles
|NOP
MOVL  **+,ACC,ARP0     ; Array2[i] = ACC, point to XAR0
XBANZ Loop,*--,ARP2   ; Loop if AR[ARP] != 0, AR[ARP]--,
; point to XAR2

```

**NORM ACC, \*ind***Normalize ACC and Modify Selected Auxiliary Register*

SYNTAX OPTIONS	OPCODE	OBJMODE	RPT	CYC
NORM ACC, *	0101 0110 0010 0100	1	Y	N+4
NORM ACC, *++	0101 0110 0101 1010	1	Y	N+4
NORM ACC, *--	0101 0110 0010 0000	1	Y	N+4
NORM ACC, *0++	0101 0110 0111 0111	1	Y	N+4
NORM ACC, *0--	0101 0110 0011 0000	1	Y	N+4

**Operands**    **ACC**    Accumulator register  
                   **\*ind**    \*, \*++, \*--, \*0++, \*0-- indirect addressing modes (see Chapter 5)

**Description**                    Normalize the signed content of the ACC register and modify, as specified by the indirect addressing mode, the auxiliary register (XAR0 to XAR7) pointed to by the auxiliary register pointer (ARP):

**Note:** The NORM instruction normalizes a signed number in the ACC register by finding the magnitude of the number. An XOR operation is performed on ACC bits 31 and 30. If the bits are the same, then the content of the ACC register is logically shifted left by 1 to eliminate the extra sign bit and the selected pointer is modified. If the bits are different, the ACC is not shifted and the selected pointer is not modified. The selected pointer does not access any memory location.

**Flags and Modes**

**Z**                    After the operation, the Z flag is set if the ACC value is zero, else Z is cleared.

**N**                    After the operation, the N flag is set if bit 31 of the ACC is 1, else N is cleared.

**TC**                    If the operation set TC, no normalization was needed (ACC did not need to be modified). If the operation cleared TC, bits 31 and 30 were the same and, as a result, the ACC register was logically shifted left by 1.

**ARP**                    Auxiliary register pointer selects which pointer to modify as part of the operation (XAR0 to XAR7).

**Repeat**                    This instruction is repeatable. If the operation follows a RPT instruction, then the NORM instruction will be executed N+1 times. The state of the Z, N, and TC flags will reflect the final result. Note: If you only want the NORM instruction to execute until normalization is done, you can create a loop that checks the value of the TC bit. When TC = 1, normalization is complete.



**Example**     ; Normalize the contents of VarA,  
              ; XAR2 will contain shift value at the end of the operation:  
          MOVL    ACC,@VarA     ; ACC = VarA  
          MOVB    XAR2,#0       ; Initialize XAR2 to zero  
          NOP     \*,ARP2        ; Set ARP pointer to point to XAR2  
          SBF     Skip,EQ       ; Skip if ACC value is zero  
          RPT     #31           ; Repeat next operation 32 times  
          | |NORM   ACC,\*++     ; Normalize contents of ACC  
          Skip:

**NORM ACC,XARn+/--** *Normalize ACC and Modify Selected Auxiliary Register.*

SYNTAX OPTIONS	OPCODE	OBJMODE	RPT	CYC
NORM ACC,XARn++	1111 1111 0111 1nnn	X	Y	N+4
NORM ACC,XARn--	1111 1111 0111 0nnn	X	Y	N+4

**Operands**    **ACC**    Accumulator register  
                   **XARn**    XAR0 to XAR7, auxiliary registers post incremented or decremented  
                   **+/---**

**Description**                    Normalize the signed content of the ACC register and modify the specified auxiliary register (XAR0 to XAR7):

```

if (ACC != 0x0000 0000)
{
    if ((ACC(31) XOR ACC(30)) = 0)
    {
        ACC = ACC << 1, TC = 0;
        if (XARn++ addressing mode) XARn += 1;
        if (XARn-- addressing mode) XARn -= 1;
    }
    else
        TC = 1;
}
else
    TC = 1;

```

**Note:** The NORM instruction normalizes a signed number in the ACC register by finding the magnitude of the number. An XOR operation is performed on ACC bits 31 and 30. If the bits are the same, then the content of the ACC register is logically shifted left by 1 to eliminate the extra sign bit and the selected pointer is modified. If the bits are different, the ACC is not shifted and the selected pointer is not modified. The selected pointer does not access any memory location.

**Flags and Modes**

**Z**                    After the operation, the Z flag is set if the ACC value is zero, else Z is cleared.

**N**                    After the operation, the N flag is set if bit 31 of the ACC is 1, else N is cleared.

**TC**                    If the operation set TC, no normalization was needed (ACC did not need to be modified). If the operation cleared TC, bits 31 and 30 were the same and, as a result, the ACC register was logically shifted left by 1.

**Repeat**                    This instruction is repeatable. If the operation follows a RPT instruction, then the NORM instruction will be executed N+1 times. The state of the Z, N, and TC flags will reflect the final result. Note: If you only want the NORM instruction to execute until normalization is done, you can create a loop that checks the value of the TC bit. When TC = 1, normalization is complete.

**Example**     ; Normalize the contents of VarA,  
              ; XAR2 will contain shift value at the end of the operation:  
          MOVL   ACC,@VarA     ; ACC = VarA  
          MOVB   XAR2,#0       ; Initialize XAR2 to zero  
          SBF     Skip,EQ       ; Skip if ACC value is zero  
          RPT     #31           ; Repeat next operation 32 times  
          | |NORM   ACC,XAR2++   ; Normalize contents of ACC  
          Skip:

**NOT ACC***Complement Accumulator*

SYNTAX OPTIONS	OPCODE	OBJMODE	RPT	CYC
NOT ACC	1111 1111 0101 0101	X	-	1

**Operands**    **ACC**    Accumulator register

**Description**            The content of the ACC register is replaced with its complement:

`ACC = ACC XOR 0xFFFFFFFF;`

**Flags and Modes**    **N**            After the operation, the N flag is set if bit 31 of the ACC is 1, else N is cleared.

**Z**            After the operation, the Z flag is set if the ACC is zero, else Z is cleared.

**Repeat**                    This instruction is not repeatable. If this instruction follows the RPT instruction, it resets the repeat counter (RPTC) and executes only once.

**Example**                ; Complement the contents of VarA:

```

MOVL   ACC,@VarA           ; ACC = VarA
NOT    ACC                  ; Complement ACC contents
MOVL   @VarA,ACC           ; Store result into VarA

```

**NOT AX***Complement AX Register*

SYNTAX OPTIONS	OPCODE	OBJMODE	RPT	CYC
NOT AX	1111 1111 0101 111A	X	–	1

**Operands**    **AX**        Accumulator high (AH) or accumulator low (AL) register

**Description**        Replace the contents of the specified AX register (AH or AL) with its complement:

`AX = AX XOR 0xFFFF;`

**Flags and Modes**    **N**        After the operation, if bit 15 of AX is 1 then the negative flag bit is set; otherwise it is cleared.

**Z**        After the operation, if AX is 0, then the Z bit is set, otherwise it is cleared.

**Repeat**                This instruction is not repeatable. If this instruction follows the RPT instruction, it resets the repeat counter (RPTC) and executes only once.

**Example**              ; Complement the contents of VarA:  
MOV    AL,@VarA                            ; Load AL with contents of VarA  
NOT    AL                                    ; Complement contents of AL  
MOV    @VarA,AL                            ; Store result in VarA

**OR ACC, loc16***Bitwise OR*

SYNTAX OPTIONS	OPCODE	OBJMODE	RPT	CYC
OR ACC, loc16	1010 1111 LLLL LLLL	1	Y	N+1

**Operands**    **ACC**    Accumulator register

**loc16**    Addressing mode (see Chapter 5)

**Description**                    Perform a bitwise OR operation on the ACC register with the zero-extended content of the location pointed to by the “loc16” address mode. The result is stored in the ACC register:

```
ACC = ACC OR 0:[loc16];
```

**Flags and Modes**    **N**            The load to ACC is tested for a negative condition. If bit 31 of ACC is 1, then the negative flag bit is set; otherwise it is cleared.

**Z**            The load to ACC is tested for a zero condition. The zero flag bit is set if the operation generates ACC = 0; otherwise it is cleared

**Repeat**                            This operation is repeatable. If the operation follows a RPT instruction, then the OR instruction will be executed N+1 times. The state of the Z and N flags will reflect the final result.

**Example**                            ; Calculate the 32-bit value: VarA = VarA OR 0:VarB

```
MOVL  ACC,@VarA                    ; Load ACC with contents of VarA
```

```
OR    ACC,@VarB                    ; OR ACC with contents of 0:VarB
```

```
MOVL  @VarA,ACC                    ; Store result in VarA
```

**OR ACC,#16bit << #0..16**

*Bitwise OR*

SYNTAX OPTIONS	OPCODE	OBJMODE	RPT	CYC
OR ACC,#16bit << #0..15	0011 1110 0001 SHFT CCCC CCCC CCCC CCCC	1	-	1
OR ACC,#16bit << #16	0101 0110 0100 1010 CCCC CCCC CCCC CCCC	1	-	1

**Operands**

**ACC** Accumulator register

**#16bit** 16-bit immediate constant value

**#0..16** Shift value (default is "<< #0" if no value specified)

**Description**

Perform a bitwise OR operation on the ACC register with the given 16-bit unsigned constant value left shifted as specified. The value is zero extended and lower order bits are zero filled before the OR operation. The result is stored in the ACC register:

ACC = ACC OR (0:16bit << shift value);

**Flags and Modes**

**N** The load to ACC is tested for a negative condition. If bit 31 of ACC is 1, then the negative flag bit is set; otherwise it is cleared.

**Z** The load to ACC is tested for a zero condition. The zero flag bit is set if the operation generates ACC = 0; otherwise it is cleared

**Repeat**

This instruction is not repeatable. If this instruction follows the RPT instruction, it resets the repeat counter (RPTC) and executes only once.

**Example**

```

; Calculate the 32-bit value: VarA = VarA OR 0x08000000
MOVL ACC,@VarA           ; Load ACC with contents of VarA
OR   ACC,#0x8000 << 12   ; OR ACC with 0x08000000
MOVL @VarA,ACC           ; Store result in VarA
    
```

**OR AX, loc16***Bitwise OR*

SYNTAX OPTIONS	OPCODE	OBJMODE	RPT	CYC
OR AX, loc16	1100 101A LLLL LLLL	X	-	1

**Operands**    **AX**        Accumulator high (AH) or accumulator low (AL) register  
                   **loc16**      Addressing mode (see Chapter 5)

**Description**            Perform a bitwise OR operation on the specified AX register with the contents of the location pointed to by the "loc16" addressing mode. The result is stored in AX:

`AX = AX OR [loc16];`

**Flags and Modes**        **N**            The load to AX is tested for a negative condition. If bit 15 of AX is 1, then the negative flag bit is set; otherwise it is cleared.  
                               **Z**            The load to AX is tested for a zero condition. The zero flag bit is set if the operation generates AX = 0, otherwise it is cleared.

**Repeat**                    This instruction is not repeatable. If this instruction follows the RPT instruction, it resets the repeat counter (RPTC) and executes only once.

**Example**                ; OR the contents of VarA and VarB and store in VarC:  
 MOV    AL,@VarA                    ; Load AL with contents of VarA  
 OR     AL,@VarB                    ; OR AL with contents of VarB  
 MOV    @VarC,AL                    ; Store result in VarC



OR IER,#16bit

---

**OR IER,#16bit**

*Bitwise OR*

SYNTAX OPTIONS	OPCODE	OBJMODE	RPT	CYC
OR IER,#16bit	0111 0110 0010 0011 CCCC CCCC CCCC CCCC	X	-	2

**Operands**    **IER**        Interrupt enable register  
                 **#16bit-**    16-bit immediate constant value  
                 **Mask**

**Description**            Enable specific interrupts by performing a bitwise OR operation with the IER register and the 16-bit immediate value. The result is stored in the IER register:

`IER = IER OR #16bit;`

**Flags and Modes**            None

**Repeat**                    This instruction is not repeatable. If this instruction follows the RPT instruction, it resets the repeat counter (RPTC) and executes only once.

**Example**                    ; Enable INT1 and INT6 only. Do not modify state of other  
                 ; interrupt's enable:  
                 OR    IER,#0x0061                    ; Enable INT1 and INT6

**OR IFR,#16bit***Bitwise OR*

SYNTAX OPTIONS	OPCODE	OBJMODE	RPT	CYC
OR IFR,#16bit	0111 0110 0010 0111 CCCC CCCC CCCC CCCC	X	-	2

**Operands**    **IFR**        Interrupt flag register  
                   **#16bit**      16-bit immediate constant value

**Description**            Enable specific interrupts by performing a bitwise OR operation with the IFR register and the 16-bit immediate value. The result of the OR operation is stored in the IFR register.

IFR = IFR OR #16bit;

**Note:** Interrupt hardware has priority over CPU instruction operation in cases where the interrupt flag is being simultaneously modified by the hardware and the instruction.

This instruction should not be used with interrupts 1–12 when the peripheral interrupt expansion (PIE) block is enabled.

**Flags and Modes**            None

**Repeat**                      This instruction is not repeatable. If this instruction follows the RPT instruction, it resets the repeat counter (RPTC) and executes only once.

**Example**                    ; Trigger INT1 and INT6 only. Do not modify state of other  
                   ; interrupt's flags:  
                   OR     IFR,#0x0061                    ; Trigger INT1 and INT6

**OR loc16,#16bit**

Bitwise OR

SYNTAX OPTIONS	OPCODE	OBJMODE	RPT	CYC
OR loc16,#16bit	0001 1010 LLLL LLLL CCCC CCCC CCCC CCCC	X	-	1

**Operands**    **loc16**    Addressing mode (see Chapter 5)  
                   **#16bit**    16-bit immediate constant value

**Description**                    Perform a bitwise OR operation on the content of the location pointed to by the "loc16" addressing mode and the 16-bit immediate constant value. The result is stored in the location pointed to by "loc16":

[loc16] = [loc16] OR 16bit;

Smart Encoding:

If loc16 = AH or AL and #16bit is an 8-bit number, then the assembler will encode this instruction as ORB AX, #8bit to improve efficiency. To override this encoding, use the ORW AX, #16bit instruction alias.

**Flags and Modes**    **N**            After the operation if bit 15 of [loc16] 1, set N; otherwise, clear N.  
                           **Z**            After the operation if [loc16] is zero, set Z; otherwise, clear Z.

**Repeat**                            This instruction is not repeatable. If this instruction follows the RPT instruction, it resets the repeat counter (RPTC) and executes only once.

**Example**                    ; Set Bits 4 and 7 of VarA:  
                           ; VarA = VarA OR #(1 << 4 | 1 << 7)  
                           OR    @VarA,#(1 << 4 | 1 << 7)                    ; Set bits 4 and 7 of VarA

**OR loc16, AX***Bitwise OR*

SYNTAX OPTIONS	OPCODE	OBJMODE	RPT	CYC
OR loc16, AX	1001 100A LLLL LLLL	X	-	1

**Operands**    **loc16**    Addressing mode (see Chapter 5)

**AX**        Accumulator high (AH) or accumulator low (AL) register

**Description**            Perform a bitwise OR operation on the contents of location pointed to by the "loc16" addressing mode with the specified AX register. The result is stored in the addressed location specified by "loc16":

[loc16] = [loc16] OR AX;

This instruction performs a read-modify-write operation.

**Flags and Modes**        **N**            The load to [loc16] is tested for a negative condition. If bit 15 of [loc16] is 1, then the negative flag bit is set; otherwise it is cleared.

**Z**            The load to [loc16] is tested for a zero condition. The zero flag bit is set if the operation generates [loc16] = 0, otherwise it is cleared.

**Repeat**                    This instruction is not repeatable. If this instruction follows the RPT instruction, it resets the repeat counter (RPTC) and executes only once.

**Example**                 ; OR the contents of VarA with VarB and store in VarB:  
MOV    AL,@VarA                    ; Load AL with contents of VarA  
OR     @VarB,AL                    ; VarB = VarB OR AL

**ORB AX,#8bit***Bitwise OR 8-bit Value*

SYNTAX OPTIONS	OPCODE	OBJMODE	RPT	CYC
ORB AX, #8bit	0101 000A CCCC CCCC	X	-	1

**Operands**    **AX**        Accumulator high (AH) or accumulator low (AL) register  
                  **#8bit**        8-bit immediate constant value

**Description**                Perform a bitwise OR operation on the specified AX register with the 8-bit unsigned immediate constant zero extended. The result is stored in AX:

`AX = AX OR 0x00:8bit;`

**Flags and Modes**        **N**            The load to AX is tested for a negative condition. If bit 15 of AX is 1, then the negative flag bit is set; otherwise it is cleared.

**Z**            The load to AX is tested for a zero condition. The zero flag bit is set if the operation generates AX = 0, otherwise it is cleared.

**Repeat**                      This instruction is not repeatable. If this instruction follows the RPT instruction, it resets the repeat counter (RPTC) and executes only once.

**Example**                    ; Set bit 7 of VarA and store result in VarB:  
 MOV    AL,@VarA                    ; Load AL with contents of VarA  
 ORB    AL,#0x80                    ; OR contents of AL with 0x0080  
 MOV    @VarB,AL                    ; Store result in VarB

## OUT \*(PA),loc16

Output Data to Port

SYNTAX OPTIONS	OPCODE	OBJMODE	RPT	CYC
OUT *(PA),loc16	1011 1100 LLLL LLLL CCCC CCCC CCCC CCCC	1	–	4

**Operands**    **\*(PA)**    Immediate I/O space memory address  
                   **loc16**    Addressing mode (see Chapter 5)

**Description**            Store the 16-bit value from the location pointed to by the “loc16” addressing mode into the I/O space location pointed to by the \*(PA) operand):

```
IOspace[0x0000PA] = [loc16];
```

I/O Space is limited to 64K range (0x0000 to 0xFFFF). On the external interface (XINTF), if available on a particular device, the I/O strobe signal (XISn) is toggled during the operation. The I/O address appears on the lower 16 XINTF address lines (XA(15:0)) and the upper address lines are zeroed. The data appears on the lower 16 data lines (XD(15:0)).

**Note:** The UOUT operation is not pipeline protected. Hence, if an IN instruction immediately follows a UOUT instruction, the IN will occur before the UOUT. To be certain of the sequence of operation, use the OUT instruction, which is pipeline protected.

**Note:** The UOUT operation is not pipeline protected. Therefore, if an IN instruction immediately follows a UOUT instruction, the IN will occur before the UOUT. To be certain of the sequence of operation, use the OUT instruction, which is pipeline protected.  
 I/O space may not be implemented on all C28x devices. See the data sheet for your particular device for details.

**Flags and Modes**            None

**Repeat**                    This instruction is not repeatable. If this instruction follows the RPT instruction, it resets the repeat counter (RPTC) and executes only once.

**Example**

```
; IORegA address = 0x0300;
; IORegB address = 0x0301;
; IORegC address = 0x0302;
; IORegA = 0x0000;
; IORegB = 0x0400;
; IORegC = VarA;
; if( IORegC = 0x2000 )
;     IORegC = 0x0000;
IORegA .set 0x0300                    ; Define IORegA address
```

*OUT \*(PA),loc16*

---

```
IORegB .set 0x0301      ; Define IORegB address
IORegC .set 0x0302      ; Define IORegC address
MOV    @AL,#0           ; AL = 0
UOUT   *(IORegA),@AL    ; IOspace[IORegA] = AL
MOV    @AL,#0x0400      ; AL = 0x0400
UOUT   *(IORegB),@AL    ; IOspace[IORegB] = AL
OUT    *(IORegC),@VarA  ; IOspace[IORegC] = VarA
IN     @AL,* (IORegC)   ; AL = IOspace[IORegC]
CMP    @AL,#0x2000      ; Set flags on (AL - 0x2000)
SB     $10,NEQ          ; Branch if not equal
MOV    @AL,#0           ; AL = 0
UOUT   *(IORegC),@AL    ; IOspace[IORegC] = AL
$10:
```

**POP ACC***Pop Top of Stack to Accumulator*

SYNTAX OPTIONS	OPCODE	OBJMODE	RPT	CYC
POP ACC	0000 0110 1011 1110	X	-	1

**Operands**    **ACC**    Accumulator

**Description**                    Predecrement SP by 2. Load ACC with the 32-bit value pointed to by SP:

```
SP    -= 2;
ACC = [SP];
```

**Flags and Modes**    **N**            The load to ACC is tested for a negative condition. Bit-31 of the ACC register is the sign bit, 0 for positive, 1 for negative. The negative flag bit is set if the operation on the ACC register generates a negative value, otherwise it is cleared.

**Z**                    The load to ACC is tested for a zero condition. The bit is set if the result of the operation on the ACC register generates a 0 value, otherwise it is cleared

**Repeat**                    This instruction is not repeatable. If this instruction follows the RPT instruction, it resets the repeat counter (RPTC) and executes only once.



**POP ARn:ARm***Pop Top of Stack to 16-bit Auxiliary Registers*

SYNTAX OPTIONS	OPCODE	OBJMODE	RPT	CYC
POP AR1:AR0	0111 0110 0000 0111	X	–	1
POP AR3:AR2	0111 0110 0000 0101	X	–	1
POP AR5:AR4	0111 0110 0000 0110	X	–	1

**Operands**    **ARn:**    AR1:AR0 or AR3:AR2 or AR5:AR4 auxiliary registers  
**ARm**

**Description**            AR1:AR0 or AR3:AR2 or AR5:AR4 Predecrement SP by 2. Load the contents of two 16-bit auxiliary registers (ARn and ARm) with the value pointed to by SP and SP+1.

```
POP AR1:AR0
  SP -= 2;
  AR0 = [SP];
  AR1 = [SP+1];
  AR1H:AR0H = unchanged;
```

```
POP AR3:AR2
  SP -= 2;
  AR2 = [SP];
  AR3 = [SP+1];
  AR3H:AR2H = unchanged;
```

```
POP AR5:AR4
  SP -= 2;
  AR4 = [SP];
  AR5 = [SP+1];
  AR5H:AR4H = unchanged;
```

**Flags and Modes**            None

**Repeat**                    This instruction is not repeatable. If this instruction follows the RPT instruction, it resets the repeat counter (RPTC) and executes only once.

**POP AR1H:AR0H***Pop Top of Stack to Upper Half of Auxiliary Registers*

SYNTAX OPTIONS	OPCODE	OBJMODE	RPT	CYC
POP AR1H:AR0H	0000 0000 0000 0011	X	-	1

**Operands**    **AR1H:**    Upper 16-bits of XAR1 and XAR0 auxiliary registers  
**AR0H**

**Description**                    Predecrement SP by 2. Load the contents of AR0H with the value pointed to by SP and AR1H with the value pointed to by SP+1. The lower 16 bits of the auxiliary registers (AR0 and AR1) are left unchanged.

```
SP -= 2;
AR0H = [SP];
AR1H = [SP+1];
AR1:AR0 = unchanged;
```

**Flags and Modes**                    None

**Repeat**                            This instruction is not repeatable. If this instruction follows the RPT instruction, it resets the repeat counter (RPTC) and executes only once.

**Example**

```
.                                    ; Full context restore for an
.                                    ; interrupt or trap function
.
POP    XT                            ; 32-bit XT restore
POP XAR7                            ; 32-bit XAR7 restore
POP XAR6                            ; 32-bit XAR6 restore
POP XAR5                            ; 32-bit XAR5 restore
POP XAR4                            ; 32-bit XAR4 restore
POP XAR3                            ; 32-bit XAR5 restore
POP XAR2                            ; 32-bit XAR2 restore
POP AR1H:AR0H                      ; 16-bit AR1H and 16-bit AR0H restore
IRET
```

**POP DBGIER***Pop Top of Stack to DBGIER*

SYNTAX OPTIONS	OPCODE	OBJMODE	RPT	CYC
POP DBGIER	0111 0110 0001 0010	X	-	5

**Operands**    **DBGIER**    Debug interrupt-enable register

**Description**                    Predecrement SP by 1. Load the contents of DBGIER with the value pointed to by SP:

```
SP        -= 1;
DBGIER = [SP];
```

**Flags and Modes**                    None

**Repeat**                                This instruction is not repeatable. If this instruction follows the RPT instruction, it resets the repeat counter (RPTC) and executes only once.

**POP DP***Pop Top of Stack to the Data Page*

SYNTAX OPTIONS	OPCODE	OBJMODE	RPT	CYC
POP DP	0111 0110 0000 0011	X	-	1

**Operands**    DP        Data-page register

**Description**        Predecrement SP by 1. Load the contents of DP with the value pointed to by SP:

```
SP -= 1;
DP = [SP];
```

**Flags and Modes**        None

**Repeat**                This instruction is not repeatable. If this instruction follows the RPT instruction, it resets the repeat counter (RPTC) and executes only once.

**POP DP:ST1***Pop Top of Stack to DP and ST1*

SYNTAX OPTIONS	OPCODE	OBJMODE	RPT	CYC
POP DP:ST1	0111 0110 0000 0001	X	-	5

**Operands**    **DP:ST1**    data page register and status register 1

**Description**                    Predecrement SP by 2. Load ST1 with the value pointed to by SP and load DP with the value pointed to by SP+1:

```
SP -= 2;
ST1 = [SP];
DP = [SP+1];
```

**Flags and Modes**                None

**Repeat**                            This instruction is not repeatable. If this instruction follows the RPT instruction, it resets the repeat counter (RPTC) and executes only once.

**POP IFR***Pop Top of Stack to IFR*

SYNTAX OPTIONS	OPCODE	OBJMODE	RPT	CYC
POP IFR	0000 0000 0000 0010	X	-	5

**Operands**    IFR    Interrupt flag register

**Description**            Predecrement SP by 1. Load the contents of IFR with the value pointed to by SP:

```
SP -= 1;
IFR = [SP];
```

**Flags and Modes**            None

**Repeat**                    This instruction is not repeatable. If this instruction follows the RPT instruction, it resets the repeat counter (RPTC) and executes only once.

**POP loc16***Pop Top of Stack*

SYNTAX OPTIONS	OPCODE	OBJMODE	RPT	CYC
POP loc16	0010 1010 LLLL LLLL	X	-	2

**Operands**    **loc16**    Addressing mode (See Chapter 5)

**Description**                    Predecrement SP by 1. Load the contents of loc16 with the 16-bit value pointed to by SP.

```
SP        -= 1;
[loc16] = [SP];
```

**Flags and Modes**    **N**            If (loc16 = @AX), then the load to AX is tested for a negative condition. Bit-15 of the AX register is the sign bit, 0 for positive, 1 for negative. The negative flag bit is set if the operation on the AX register generates a negative value, otherwise it is cleared.

**Z**            If (loc16 = @AX), then the load to AX is tested for a zero condition. The bit is set if the result of the operation on the AX register generates a 0 value, otherwise it is cleared

**Repeat**                    This instruction is not repeatable. If this instruction follows the RPT instruction, it resets the repeat counter (RPTC) and executes only once.

**Example**

```
POP @T                                ; Predecrement SP by 1. Load
                                     ; XT(31:15) with the
                                     ; contents of the location pointed to
                                     ; by SP. TL is unchanged.

POP @AL                               ; Predecrement SP by 1. Load AL with
                                     ; the contents of the location pointed
                                     ; to by SP. AH is unchanged.

POP @AR4                              ; Predecrement SP by 1. Load AR4 with
                                     ; the contents of the location pointed
                                     ; to by SP. AR4H is unchanged.

POP *XAR4++                          ; Predecrement SP by 1. Load the
                                     ; 16-bit location pointed to by XAR4
                                     ; with the contents of the location
                                     ; pointed to by SP.
                                     Post-increment
                                     ; XAR4 by 1
```

**POP P***Pop top of Stack to P*

SYNTAX OPTIONS	OPCODE	OBJMODE	RPT	CYC
POP P	0111 0110 0001 0001	X	-	1

**Operands**    P        Product register

**Description**        Predecrement SP by 2. Load P with the 32-bit value pointed to by SP:

```
SP -= 2;
P   = [SP];
```

**Flags and Modes**        None

**Repeat**                This instruction is not repeatable. If this instruction follows the RPT instruction, it resets the repeat counter (RPTC) and executes only once.



**POP RPC***Pop RPC Register From Stack*

SYNTAX OPTIONS	OPCODE	OBJMODE	RPT	CYC
POP RPC	0000 0000 0000 0111	X	-	3

**Operands**    **RPC**    Return program counter register

**Description**            Predecrement SP by 2. Load the contents of RPC with the value pointed to by SP:

```
SP -= 2;
RPC = [SP];
```

**Flags and Modes**            None

**Repeat**                    This instruction is not repeatable. If this instruction follows the RPT instruction, it resets the repeat counter (RPTC) and executes only once.

**POP ST0***Pop Top of Stack to ST0*

SYNTAX OPTIONS	OPCODE	OBJMODE	RPT	CYC
POP ST0	0111 0110 0001 0011	X	-	1

**Operands**    **ST0**        status register 0

**Description**                Predecrement SP by 1. Load the contents of ST0 with the value pointed to by SP:

```
SP -= 1;
ST0 = [SP];
```

**Flags and Modes**    **C**        The bit value of each flag and mode listed is replaced by the value popped off of the stack

**N**

**V**

**Z**

**TC**

**SXM**

**OVC**

**PM**

**Repeat**                      This instruction is not repeatable. If this instruction follows the RPT instruction, it resets the repeat counter (RPTC) and executes only once.

**POP ST1***Pop Top of Stack to ST1*

SYNTAX OPTIONS	OPCODE	OBJMODE	RPT	CYC
POP ST1	0111 0110 0000 0000	X	-	5

**Operands**    **ST1**            Status register 1

**Description**                    Predecrement SP by 1. Load the contents of ST0 with the value pointed to by SP:

```
SP -= 1;
ST1 = [SP];
```

**Flags and Modes**    **DBGM**            The bit values for each flag and mode listed is replaced by the value popped off of the stack

**INTM**

**VMAP**

**SPA**

**PAGE0**

**AMODE**

**ARP**

**EALLOW**

**OBJMODE**

**XF**

**Repeat**                            This instruction is not repeatable. If this instruction follows the RPT instruction, it resets the repeat counter (RPTC) and executes only once.

**POP T:ST0***Pop Top of Stack to T and ST0*

SYNTAX OPTIONS	OPCODE	OBJMODE	RPT	CYC
POP T:ST0	0111 0110 0001 0101	X	-	1

**Operands**    **T:ST0**    The upper 16-bits of the multiplicand register and status register 0

**Description**            Predecrement SP by 2. Load ST0 with the value pointed to by SP and load T with the value pointed to by SP+1. The low 16 bits of the XT Register (TL) are left unchanged:

```
SP -= 2;
T   = [SP];
ST0 = [SP+1];
TL  = unchanged;
```

**Flags and Modes**            None

**Repeat**                    This instruction is not repeatable. If this instruction follows the RPT instruction, it resets the repeat counter (RPTC) and executes only once.

**POP XARn***Pop Top of Stack to 32-bit Auxiliary Register*

SYNTAX OPTIONS	OPCODE	OBJMODE	RPT	CYC
POP XAR0	0011 1010 1011 1110	1	–	1
POP XAR1	1011 0010 1011 1110	1	–	1
POP XAR2	1010 1010 1011 1110	1	–	1
POP XAR3	1010 0010 1011 1110	1	–	1
POP XAR4	1010 1000 1011 1110	1	–	1
POP XAR5	1010 0000 1011 1110	1	–	1
POP XAR6	1100 0010 1011 1110	X	–	1
POP XAR7	1100 0011 1011 1110	X	–	1

**Operands**    XARn    XAR0 to XAR7, 32-bit auxiliary registers

**Description**            Predecrement SP by 2. Load XARn with the 32-bit value pointed to by SP:

```
SP -= 2;
XARn = [SP];
```

**Flags and Modes**            None

**Repeat**                    This instruction is not repeatable. If this instruction follows the RPT instruction, it resets the repeat counter (RPTC) and executes only once.

**Example**

```
.                                    ; Full context restore for an
.                                    ; interrupt or trap function
.
POP    XT                            ; 32-bit XT restore
POP XAR7                            ; 32-bit XAR7 restore
POP XAR6                            ; 32-bit XAR6 restore
POP XAR5                            ; 32-bit XAR5 restore
POP XAR4                            ; 32-bit XAR4 restore
POP XAR3                            ; 32-bit XAR3 restore
POP XAR2                            ; 32-bit XAR2 restore
POP AR1H:AR0H                      ; 16-bit AR1H and 16-bit AR0H restore
IRET
```

**POP XT***Pop Top of Stack to XT*

SYNTAX OPTIONS	OPCODE	OBJMODE	RPT	CYC
POP XT	1000 0111 1011 1110	X	-	1

**Operands**    XT        Multiplicand register

**Description**        Predecrement SP by 2. Load XT with the 32-bit value pointed to by SP:

```
SP -= 2;
XT  = [SP];
```

**Flags and Modes**        None

**Repeat**                This instruction is not repeatable. If this instruction follows the RPT instruction, it resets the repeat counter (RPTC) and executes only once.

**PREAD loc16,\*XAR7**

*Read From Program Memory*

SYNTAX OPTIONS	OPCODE	OBJMODE	RPT	CYC
PREAD loc16,*XAR7	0010 0100 LLLL LLLL	X	Y	N+2

**Operands**    **loc16**    Addressing mode (see Chapter 5)  
                  **\*XAR7**    Indirect program–memory addressing using auxiliary register XAR7, can access full 4Mx16 program space range (0x000000 to 0x3FFFFFF)

**Description**                    Load the data memory–location pointed to by the “loc16” addressing mode with the 16-bit content of the program–memory location pointed to by “\*XAR7”:

```
[loc16] = Prog[*XAR7];
```

On the C28x devices, memory blocks are mapped to both program and data space (unified memory), hence the “\*XAR7” addressing mode can be used to access data space variables that fall within the program space address range.

With some addressing mode combinations, you can get conflicting references. In such cases, the C28x will give the “loc16/loc32” field priority on changes to XAR7. For example:

```
PREAD  *--XAR7,*XAR7      ; *--XAR7 given priority
PREAD  *XAR7++,*XAR7     ; *XAR7++ given priority
```

**Flags and Modes**    **N**            If (loc16 = @AX) and bit 15 of AX is 1, then N is set; otherwise N is cleared.  
                      **Z**            If (loc16 = @AX) and the value of AX is zero, then Z is set; otherwise Z is cleared.

**Repeat**                        This instruction is repeatable. If the operation follows a RPT instruction, then it will be executed N+1 times. When repeated, the “\*XAR7” program–memory address is copied to an internal shadow register and the address is post–incremented by 1 during each repetition.

```
Example            ; Copy the contents of Array1 to Array2:
                     ; int16 Array1[N]
                     ;            // Located in program space
                     ; int16 Array [N]
                     ;            // Located in data space
                     ; for(i=0; i N; i++)
                     ; Array2[i] = Array1[i];
                     MOVL    XAR7,#Array1            ; XAR7 = pointer to Array1
                     MOVL    XAR2,#Array2           ; XAR2 = pointer to Array2
```

```
RPT    #(N-1)           ; Repeat next instruction N times
||PREAD *XAR2++,*XAR7    ; Array2[i] = Array1[i],
                          ; i++
```



**PUSH ACC**

*Push Accumulator Onto Stack*

SYNTAX OPTIONS	OPCODE	OBJMODE	RPT	CYC
PUSH ACC	0001 1110 1011 1101	X	-	2

**Note:** This instruction is an alias for the MOV\*SP++, ACC instruction.

**Operands**    **ACC**    Accumulator register

**Description**                    Push the 32-bit contents of ACC onto the stack pointed to by SP.  
Post-increment SP by 2:

[SP] = ACC;  
SP += 2;

**Flags and Modes**                    None

**Repeat**                                This instruction is not repeatable. If this instruction follows the RPT instruction, it resets the repeat counter (RPTC) and executes only once.

**Example**

```

MOVL XAR4, #VarA                    ; Initialize XAR4 pointer with the
                                     ; 22-bit address of VarA
MOVL ACC, *+XAR4[0]                 ; Load the 32-bit contents of VarA
                                     ; into ACC
PUSH ACC                             ; Push the 32-bit ACC into the
                                     ; location pointed to by SP.
                                     ; Post-increment SP by 2
    
```

**PUSH ARn:ARm**

*Push 16-bit Auxiliary REgisters Onto Stack*

SYNTAX OPTIONS	OPCODE	OBJMODE	RPT	CYC
PUSH AR1:AR0	0111 0110 0000 1101	X	–	1
PUSH AR3:AR2	0111 0110 0000 1111	X	–	1
PUSH AR5:AR4	0111 0110 0000 1100	X	–	1

**Operands**    **ARn:**    AR1:AR0 or AR3:AR2 or AR5:AR4 auxiliary registers  
                   **ARm**

**Description**                    Push the contents of two 16-bit auxiliary registers (ARn and ARm) onto the stack pointed to by SP.  
     Post-increment SP by 2:

```
PUSH AR1:AR0
  [SP]   = AR0;
  [SP+1] = AR1;
  SP    += 2;
```

```
PUSH AR3:AR2
  [SP]   = AR2;
  [SP+1] = AR3;
  SP    += 2;
```

```
PUSH AR5:AR4
  [SP]   = AR4;
  [SP+1] = AR5;
  SP    += 2;
```

**Flags and Modes**                    None

**Repeat**                            This instruction is not repeatable. If this instruction follows the RPT instruction, it resets the repeat counter (RPTC) and executes only once.



**PUSH DBGIER***Push DBGIER Register Onto Stack*

SYNTAX OPTIONS	OPCODE	OBJMODE	RPT	CYC
PUSH DBGIER	0111 0110 0000 1110	X	-	1

**Operands**    **DBGIER**    Debug interrupt enable register

**Description**                    Push the 16-bit contents of DBGIER onto the stack pointed to by SP.  
Post-increment SP by 1:

```
[SP] = DBGIER;
SP += 1;
```

**Flags and Modes**                    None

**Repeat**                            This instruction is not repeatable. If this instruction follows the RPT instruction, it resets the repeat counter (RPTC) and executes only once.

**PUSH DP**

*Push DP Register Onto Stack*

SYNTAX OPTIONS	OPCODE	OBJMODE	RPT	CYC
PUSH DP	0111 0110 0000 1011	X	-	1

**Operands**    DP        Data-page register

**Description**            Push the 16-bit contents of DP onto the stack pointed to by SP.  
Post-increment SP by 1:  
  
          [SP] = DP;  
          SP += 1;

**Flags and Modes**            None

**Repeat**                    This instruction is not repeatable. If this instruction follows the RPT instruction, it resets the repeat counter (RPTC) and executes only once.

**PUSH DP:ST1***Push DP and ST1 Onto Stack*

SYNTAX OPTIONS	OPCODE	OBJMODE	RPT	CYC
PUSH DP:ST1	0111 0110 0000 1001	X	-	1

**Operands**    DP:ST1    Data-page register and status register 1

**Description**                    Push the 16-bit contents of ST1 followed by the 16-bit contents of DP onto the stack pointed to by SP.  
Post-increment SP by 2:

```
[SP]   = ST1;
[SP+1] = DP;
SP     += 2;
```

**Flags and Modes**                None

**Repeat**                            This instruction is not repeatable. If this instruction follows the RPT instruction, it resets the repeat counter (RPTC) and executes only once.

**PUSH IFR**

*Push IFR Onto Stack*

SYNTAX OPTIONS	OPCODE	OBJMODE	RPT	CYC
PUSH IFR	0111 0110 0000 1010	X	-	1

**Operands**    IFR        Interrupt flag register

**Description**                    Push the 16-bit contents of IFR onto the stack pointed to by SP.  
 Post-increment SP by 1:  
  
           [SP] = IFR;  
           SP += 1;

**Flags and Modes**                    None

**Repeat**                                This instruction is not repeatable. If this instruction follows the RPT instruction, it resets the repeat counter (RPTC) and executes only once.

**PUSH loc16***Push 16-bit Value on Stack*

SYNTAX OPTIONS	OPCODE	OBJMODE	RPT	CYC
PUSH loc16	0010 0010 LLLL LLLL	X	-	2

**Operands**    **loc16**    Addressing mode (see Chapter 5)

**Description**                    Push a 16-bit value pointed to by the “loc16” operand on the stack pointed to by SP.  
Post-increment SP by 1:

```
[SP] = [loc16];
SP += 1;
```

**Flags and Modes**                    None

**Repeat**                            This instruction is not repeatable. If this instruction follows the RPT instruction, it resets the repeat counter (RPTC) and executes only once.

**Example**

```
PUSH @T                                ; Push the contents of XT(31:15) into
                                      ; the location pointed to by
                                      ; SP. Post-increment SP by 1

PUSH @AL                               ; Push the contents of AL onto into
                                      ; the location pointed to by
                                      ; SP. Post-increment SP by 1

PUSH @AR4                             ; Push the lower 16-bits of XAR4 into
                                      ; the location pointed to by
                                      ; SP. Post-increment SP by 1

PUSH *XAR4++                         ; Push the value pointed to by XAR4
                                      ; into the location pointed to
                                      ; by SP. Post-increment SP and XAR4
                                      ; by 1
```



PUSH P

---

**PUSH P**

*Push P Onto Stack*

SYNTAX OPTIONS	OPCODE	OBJMODE	RPT	CYC
PUSH P	0111 0110 0001 1101	X	-	1

**Operands**    P            Product register

**Description**            Push the 32-bit contents of P onto the stack pointed to by SP  
Post-increment SP by 2:

[SP] = P;  
SP += 2;

**Flags and Modes**            None

**Repeat**                    This instruction is not repeatable. If this instruction follows the RPT instruction, it resets the repeat counter (RPTC) and executes only once.

**Example**

```
MOVL XAR5, #VarA                    ; Initialize XAR5 pointer with the
                                      ; 22-bit address of VarA
MOVL P,    *+XAR5[0]                ; Load the 32-bit contents of VarA
                                      ; into P
PUSH P                                ; Push the 32-bit P into the
                                      ; location pointed to by SP.
                                      ; Post-increment SP by 2
```

**PUSH RPC***Push RPC Onto Stack*

SYNTAX OPTIONS	OPCODE	OBJMODE	RPT	CYC
PUSH RPC	0000 0000 0000 0100	X	-	1

**Operands**    **RPC**    Return program counter register

**Description**                    Push the contents of the RPC register onto the stack pointed to by SP.  
Post-increment SP by 2:

```
[SP] = RPC;
SP += 2;
```

**Flags and Modes**                    None

**Repeat**                            This instruction is not repeatable. If this instruction follows the RPT instruction, it resets the repeat counter (RPTC) and executes only once.

**PUSH ST0**

*Push ST0 Onto Stack*

SYNTAX OPTIONS	OPCODE	OBJMODE	RPT	CYC
PUSH ST0	0111 0110 0001 1000	X	-	1

**Operands**    **ST0**    Status register 0

**Description**                    Push the 16-bit contents of ST0 onto the stack pointed to by SP.  
Post-increment SP by 1:  
  
                                  [SP] = ST0;  
                                  SP += 1;

**Flags and Modes**                    None

**Repeat**                                This instruction is not repeatable. If this instruction follows the RPT instruction, it resets the repeat counter (RPTC) and executes only once.

**PUSH ST1***Push ST1 Onto Stack*

SYNTAX OPTIONS	OPCODE	OBJMODE	RPT	CYC
PUSH ST1	0111 0110 0000 1000	X	-	1

**Operands**    ST1        Status register 1

**Description**                    Push the 16-bit contents of ST1 onto the stack pointed to by SP.  
Post-increment SP by 1:

[SP] = ST1;  
SP += 1;

**Flags and Modes**                    None

**Repeat**                                This instruction is not repeatable. If this instruction follows the RPT instruction, it resets the repeat counter (RPTC) and executes only once.

**PUSH T:ST0**

*Push T and ST0 Onto Stack*

SYNTAX OPTIONS	OPCODE	OBJMODE	RPT	CYC
PUSH T:ST0	0111 0110 0001 1001	X	-	1

**Operands**    **T:ST0**    The upper 16-bits of the multiplicand register and status register 0

**Description**                    Push the 16- bit contents of ST0 followed by the 16-bit contents of T onto the stack pointed to by SP. Post-increment SP by 2:

```
[SP]   = ST0;
[SP+1] = T;
SP     += 2;
```

**Flags and Modes**                None

**Repeat**                            This instruction is not repeatable. If this instruction follows the RPT instruction, it resets the repeat counter (RPTC) and executes only once.



PUSH XT

---

**PUSH XT**

*Push XT Onto Stack*

SYNTAX OPTIONS	OPCODE	OBJMODE	RPT	CYC
PUSH XT	1010 1011 1011 1101	X	-	1

**Operands**    XT        Multiplicand register

**Description**            Push the 32-bit contents of XT onto the stack pointed to by SP.  
Post-increment SP by 2:

[SP] = XT;  
SP += 2;

**Flags and Modes**            None

**Repeat**                    This instruction is not repeatable. If this instruction follows the RPT instruction, it resets the repeat counter (RPTC) and executes only once.

**Example**

```
MOVL XAR1, #VarA                    ; Initialize XAR1 pointer with the
                                     ; 22-bit address of VarA
MOVL XT, *+XAR5[0]                  ; Load the 32-bit contents of VarA
                                     ; into XT
PUSH XT                               ; Push the 32-bit XT into the
                                     ; location pointed to by SP.
                                     ; Post-increment SP by 2
```

**PWRITE \*XAR7,loc16***Write to Program Memory*

SYNTAX OPTIONS	OPCODE	OBJMODE	RPT	CYC
PWRITE *XAR7, loc16	0010 0110 LLLL LLLL	X	Y	N+5

**Operands**    **\*XAR7**    Indirect program–memory addressing using auxiliary register XAR7, can access full 4Mx16 program space range (0x000000 to 0x3FFFFFF)

**loc16**    Addressing mode (see Chapter 5)

**Description**            Load the program–memory location pointed to by the “\*XAR7” with the content of the location pointed to by the “loc16” addressing mode:

```
Prog[*XAR7] = [loc16];
```

On the C28x devices, memory blocks are mapped to both program and data space (unified memory), hence the “\*XAR7” addressing mode can be used to access data space variables that fall within the program space address range.

With some addressing mode combinations, you can get conflicting references. In such cases, the C28x will give the “loc16/loc32” field priority on changes to XAR7. For example:

```
PWRITE *XAR7,*--XAR7            ; *--XAR7 given priority
PWRITE *XAR7,*XAR7++           ; *XAR7++ given priority
```

**Flags and Modes**            None

**Repeat**                    This instruction is repeatable. If the operation follows a RPT instruction, then it will be executed N+1 times. When repeated, the “\*XAR7” program–memory address is copied to an internal shadow register and the address is post–incremented by 1 during each repetition.

**Example**                    ; Copy the contents of Array1 to Array2:  

```

; int16 Array1[N]; // Located in data space
; int16 Array2[N]; // Located in program space
; for(i=0; i < N; i++)
;   Array2[i] = Array1[i];
MOVL  XAR2,#Array1            ; XAR2 = pointer to Array1
MOVL  XAR7,#Array2            ; XAR7 = pointer to Array2
RPT   #(N-1)                  ; Repeat next instruction N times
| | PWRITE *XAR7,*XAR2++      ; Array2[i] = Array1[i],
; i++
```



**QMACL P,loc32,\*XAR7/++**

*Signed 32 X 32-bit Multiply and Accumulate (Upper Half)*

SYNTAX OPTIONS	OPCODE	OBJMODE	RPT	CYC
QMACL P,loc32,*XAR7	0101 0110 0100 1111 1100 0111 LLLL LLLL	1	Y	N+2
QMACL P,loc32,*XAR7++	0101 0110 0100 1111 1000 0111 LLLL LLLL	1	Y	N+2

**Operands**    **P**        Product register

**loc32**    Addressing mode (see Chapter 5)

**Note:** The @ACC addressing mode cannot be used when the instruction is repeated. No illegal instruction trap will be generated if used (assembler will flag an error).

**\*XAR7/**    Indirect program–memory addressing using auxiliary register XAR7,

**++**        can access full 4Mx16 program space range (0x000000 to 0x3FFFFFF)

**Description**                    32-bit x 32-bit signed multiply and accumulate. First, add the previous product (stored in the P register), shifted as specified by the product shift mode (PM), to the ACC register. Then, multiply the signed 32-bit content of the location pointed to by the “loc32” addressing mode by the signed 32-bit content of the program–memory location pointed to by the XAR7 register and store the upper 32–bits of the 64-bit result in the P register. If specified, post-increment the XAR7 register by 2:

```
ACC = ACC + P << PM;
P = (signed T * signed Prog[*XAR7 or *XAR7++]) >> 32;
```

On the C28x devices, memory blocks are mapped to both program and data space (unified memory), hence the “\*XAR7/++” addressing mode can be used to access data space variables that fall within the program space address range.

With some addressing mode combinations, you can get conflicting references. In such cases, the C28x will give the “loc16/loc32” field priority on changes to XAR7. For example:

```
QMACL    P, --XAR7, *XAR7++        ; --XAR7 given priority
QMACL    P, *XAR7++, *XAR7        ; *XAR7++ given priority
QMACL    P, *XAR7, *XAR7++        ; *XAR7++ given priority
```

**Flags and Modes**    **Z**        After the addition, the Z flag is set if the ACC value is zero, else Z is cleared.

**N**        After the addition, the N flag is set if bit 31 of the ACC is 1, else N is cleared.

<b>C</b>	If the addition generates a carry, C is set; otherwise C is cleared.
<b>V</b>	If an overflow occurs, V is set; otherwise V is not affected.
<b>OVC</b>	If overflow mode is disabled; and if the operation generates a positive overflow, then the counter is incremented. If overflow mode is disabled; and if the operation generates a negative overflow, then the counter is decremented.
<b>OVM</b>	If overflow mode bit is set; then the ACC value will saturate maximum positive (0x7FFFFFFF) or maximum negative (0x80000000) if the operation overflowed.
<b>PM</b>	The value in the PM bits sets the shift mode for the output operation from the product register. If the product shift value is positive (logical left shift operation), then the low bits are zero filled. If the product shift value is negative (arithmetic right shift operation), the upper bits are sign extended.

**Repeat** This instruction is repeatable. If the operation follows a RPT instruction, then it will be executed N+1 times. The state of the Z, N, C and OVC flags will reflect the final result in the ACC. The V flag will be set if an intermediate overflow occurs in the ACC.

**Example**

```

; Calculate sum of product using 32-bit multiply and retain
; high result:
; int32 X[N]; // Data information
; int32 C[N]; // Coefficient information (located in low 4M)
; int32 sum = 0;
; for(i=0; i < N; i++)
;   sum = sum + ((X[i] * C[i]) >> 32) >> 5;
MOVL  XAR2,#X           ; XAR2 = pointer to X
MOVL  XAR7,#C           ; XAR7 = pointer to C
SPM   -5                ; Set product shift to ">> 5"
ZAPA                      ; Zero ACC, P, OVC
RPT   #(N-1)           ; Repeat next instruction N times
| |QMACL P,*XAR2++,*XAR7++ ; ACC = ACC + P >> 5,
; P = (X[i] * C[i]) >> 32
; i++
ADDL  ACC,P << PM       ; Perform final accumulate
MOVL  @sum,ACC          ; Store final result into sum

```

**QMPYAL P,XT,loc32**

*Signed 32-bit Multiply (Upper Half) and Add Previous P*

SYNTAX OPTIONS	OPCODE	OBJMODE	RPT	CYC
QMPYAL P,XT,loc32	0101 0110 0100 0110 0000 0000 LLLL LLLL	1	-	1

- Operands**
- P** Product register
  - XT** Multiplicand register
  - loc32** Addressing mode (see Chapter 5)

**Description** Signed 32-bit x 32-bit multiply and accumulate the previous product. Add the previous signed product (stored in the P register), shifted as specified by the product shift mode (PM), to the ACC register. In addition, multiply the signed 32-bit content of the XT register by the signed 32-bit content of the location pointed to by the “loc32” addressing mode and store the upper 32–bits of the 64-bit result in the P register:

$$ACC = ACC + P \ll PM;$$

$$P = (\text{signed } T * \text{signed } [loc32]) \gg 32;$$

- Flags and Modes**
- Z** After the addition, the Z flag is set if the ACC value is zero, else Z is cleared.
  - N** After the addition, the N flag is set if bit 31 of the ACC is 1, else N is cleared.
  - C** If the addition generates a carry, C is set; otherwise C is cleared.
  - V** If an overflow occurs, V is set; otherwise V is not affected.
  - OVC** If overflow mode is disabled; and if the operation generates a positive overflow, then the counter is incremented. If overflow mode is disabled; and if the operation generates a negative overflow, then the counter is decremented.
  - OVM** If overflow mode bit is set; then the ACC value will saturate maximum positive (0x7FFFFFFF) or maximum negative (0x80000000) if the operation overflowed.
  - PM** The value in the PM bits sets the shift mode for the output operation from the product register. If the product shift value is positive (logical left shift operation), then the low bits are zero filled. If the product shift value is negative (arithmetic right shift operation), the upper bits are sign extended.

**Repeat** This instruction is not repeatable. If this instruction follows the RPT instruction, it resets the repeat counter (RPTC) and executes only once.

**Example**     ; Calculate signed result:  
              ; Y32 = (X0\*C0 + X1\*C1 + X2\*C2) >> (32 + 2)

```
SPM      -2                ; Set product shift mode to ">> 2"
ZAPA                    ; Zero ACC, P, OVC
MOVL     XT,@X0          ; XT = X0
QMPYAL   P,XT,@C0        ; P = high 32-bits of (X0*C0)
MOVL     XT,@X1          ; XT = X0
QMPYAL   P,XT,@C1        ; ACC = ACC + P >> 2,
                        ; P = high 32-bits of (X1*C1)
MOVL     XT,@X2          ; XT = X0
QMPYAL   P,XT,@C2        ; ACC = ACC + P >> 2,
                        ; P = high 32-bits of (X2*C2)
ADDL     ACC,P << PM     ; ACC = ACC + P >> 2
MOVL     @Y32,ACC        ; Store result into Y32
```

**QMPYL P,XT,loc32***Signed 32 X 32-bit Multiply (Upper Half)*

SYNTAX OPTIONS	OPCODE	OBJMODE	RPT	CYC
QMPYL P,XT,loc32	0101 0110 0110 0111 0000 0000 LLLL LLLL	1	-	1

**Operands**

**P** Product register

**XT** Multiplicand register

**loc32** Addressing mode (see Chapter 5)

**Description** Multiply the signed 32-bit content of the XT register by the signed 32-bit content of the location pointed to by the "loc32" addressing mode and store the upper 32-bits of the 64-bit result (a Q30 number) in the P register:

$$P = (\text{signed } XT * \text{signed } [\text{loc32}]) \gg 32;$$

**Flags and Modes** None

**Repeat** This instruction is not repeatable. If this instruction follows the RPT instruction, it resets the repeat counter (RPTC) and executes only once.

**Example**

```

; Calculate signed result: Y64 = M32*X32 + B64
MOVL  XT,@M32          ; XT = M32
IMPYL P,XT,@X32       ; P = low 32-bits of (M32*X32)
MOVL  ACC,@B64+2     ; ACC = high 32-bits of B64
ADDUL P,@B64+0       ; P = P + low 32-bits of B64
MOVL  @Y64+0,P       ; Store low 32-bit result into Y64
QMPYL P,XT,@X32     ; P = high 32-bits of (M32*X32)
ADDCL ACC,@P        ; ACC = ACC + P + carry
MOVL  @Y64+2,ACC     ; Store high 32-bit result into Y64

```

**QMPYL ACC,XT,loc32***Signed 32 X 32-bit Multiply (Upper Half)-*

SYNTAX OPTIONS	OPCODE	OBJMODE	RPT	CYC
QMPYL ACC,XT,loc32	0101 0110 0110 0011 0000 0000 LLLL LLLL	1	-	2

**Operands**

**P** Product register

**XT** Multiplicand register

**ACC** Accumulator register

**Description**

Multiply the signed 32-bit content of the XT register by the signed 32-bit content of the location pointed to by the "loc32" addressing mode and store the upper 32-bits of the 64-bit result (a Q30 number) in the ACC register:

$ACC = (\text{signed } XT * \text{signed } [loc32]) \gg 32;$

**Flags and Modes**

**Z** After the operation, the Z flag is set if the ACC value is zero, else Z is cleared.

**N** After the operation, the N flag is set if bit 31 of the ACC is 1, else N is cleared.

**Repeat**

This instruction is not repeatable. If this instruction follows the RPT instruction, it resets the repeat counter (RPTC) and executes only once.

**Example**

```

; Calculate signed result: Y64 = M32*X32
MOVL  XT,@M32           ; XT = M32
IMPYL P,XT,@X32        ; P = low 32-bits of (M32*X32)
QMPYL ACC,XT,@X32      ; ACC = high 32-bits of (M32*X32)
MOVL  @Y64+0,P         ; Store result into Y64
MOVL  @Y64+2,ACC

```

**QMPYSL P,XT,loc32**

*Signed 32-bit Multiply (Upper Half) and Subtract Previous P*

SYNTAX OPTIONS	OPCODE	OBJMODE	RPT	CYC
QMPYSL P,XT,loc32	0101 0110 0100 0101 0000 0000 LLLL LLLL	1	-	1

- Operands**
- P** Product register
  - XT** Multiplicand register
  - loc32** Addressing mode (see Chapter 5)

**Description** Signed 32-bit x 32-bit multiply and subtract the previous product. Subtract the previous signed product (stored in the P register), shifted as specified by the product shift mode (PM), from the ACC register. In addition, multiply the signed 32-bit content of the XT register by the signed 32-bit constant value and store the upper 32-bits of the 64-bit result in the P register:

$$ACC = ACC - P \ll PM;$$

$$P = (\text{signed } T * \text{signed } [loc32]) \gg 32;$$

- Flags and Modes**
- Z** After the subtraction, the Z flag is set if the ACC value is zero, else Z is cleared.
  - N** After the subtraction, the N flag is set if bit 31 of the ACC is 1, else N is cleared.
  - C** If the subtraction generates a borrow, C is cleared; otherwise C is set.
  - V** If an overflow occurs, V is set; otherwise V is not affected.
  - OVC** If overflow mode is disabled; and if the operation generates a positive overflow, then the counter is incremented. If overflow mode is disabled; and if the operation generates a negative overflow, then the counter is decremented.
  - OVM** If overflow mode bit is set; then the ACC value will saturate maximum positive (0x7FFFFFFF) or maximum negative (0x80000000) if the operation overflowed.
  - PM** The value in the PM bits sets the shift mode for the output operation from the product register. If the product shift value is positive (logical left shift operation), then the low bits are zero filled. If the product shift value is negative (arithmetic right shift operation), the upper bits are sign extended.

**Repeat** This instruction is not repeatable. If this instruction follows the RPT instruction, it resets the repeat counter (RPTC) and executes only once.

**Example** ; Calculate signed result:  
; Y32 = -(X0\*C0 + X1\*C1 + X2\*C2) >> (32 + 2)

```
SPM    -2                ; Set product shift mode to ">> 2"
ZAPA                    ; Zero ACC, P, OVC
MOVL   XT,@X0           ; XT = X0
QMPYSL P,XT,@C0         ; P = high 32-bits of (X0*C0)
MOVL   XT,@X1           ; XT = X0
QMPYSL P,XT,@C1         ; ACC = ACC - P >> 2,
                        ; P = high 32-bits of (X1*C1)
MOVL   XT,@X2           ; XT = X0
QMPYSL P,XT,@C2         ; ACC = ACC - P >> 2,
                        ; P = high 32-bits of (X2*C2)
SUBL   ACC,P << PM      ; ACC = ACC - P >> 2
MOVL   @Y32,ACC         ; Store result into Y32
```



**QMPYUL P,XT,loc32**

*Unsigned 32 X 32-bit Multiply (Upper Half)*

SYNTAX OPTIONS	OPCODE	OBJMODE	RPT	CYC
QMPYUL P,XT,loc32	0101 0110 0100 0111 0000 0000 LLLL LLLL	1	-	1

**Operands**

**P** Product register

**XT** Multiplicand register

**loc32** Addressing mode (see Chapter 5)

**Description** Multiply the unsigned 32-bit content of the XT register by the unsigned 32-bit content of the location pointed to by the "loc32" addressing mode and store the upper 32-bits of the 64-bit result in the P register:

$$P = (\text{unsigned } XT * \text{unsigned } [\text{loc32}]) \gg 32;$$

**Flags and Modes** None

**Repeat** This instruction is not repeatable. If this instruction follows the RPT instruction, it resets the repeat counter (RPTC) and executes only once.

**Example**

```

; Calculate unsigned result: Y64 = M32*X32 + B64
MOVL  XT,@M32          ; XT = M32
IMPYL  P,XT,@X32       ; P = low 32-bits of (M32*X32)
MOVL  ACC,@B64+2      ; ACC = high 32-bits of B64
ADDUL  P,@B64+0       ; P = P + low 32-bits of B64
MOVL  @Y64+0,P        ; Store low 32-bit result into Y64
QMPYUL P,XT,@X32      ; P = high 32-bits of (M32*X32)
ADDCL  ACC,@P          ; ACC = ACC + P + carry
MOVL  @Y64+2,ACC      ; Store high 32-bit result into Y64
    
```

**QMPYXUL P,XT,loc32***Signed X Unsigned 32-bit Multiply (Upper Half)*

SYNTAX OPTIONS	OPCODE	OBJMODE	RPT	CYC
QMPYXUL P,XT,loc32	0101 0110 0100 0010 0000 0000 LLLL LLLL	1	-	1

**Operands**

**P** Product register

**XT** Multiplicand register

**loc32** Addressing mode (see Chapter 5)

**Description**

Multiply the signed 32-bit content of the XT register by the unsigned 32-bit content of the location pointed to by the "loc32" addressing mode and store the upper 32-bits of the 64-bit result in the P register:

$$P = (\text{signed } XT * \text{unsigned } [\text{loc32}]) \gg 32;$$

**Flags and Modes**

None

**Repeat**

This instruction is not repeatable. If this instruction follows the RPT instruction, it resets the repeat counter (RPTC) and executes only once.

**Example**

```

; Calculate signed result: Y64 = (M64*X64) >> 64 + B64
; Y64 = Y1:Y0, M64 = M1:M0, X64 = X1:X0, B64 = B1:B0
MOVL   XT,@X1           ; XT = X1
QMPYXUL P,XT,@M0        ; P = high 32-bits of (uns M0 * sign X1)
MOV    @T,#32           ; T = 32
LSL64  ACC:P,T          ; ACC:P = ACC:P << T
ASR64  ACC:P,T          ; ACC:P = ACC:P >> T
MOVL   @XAR4,P          ; XAR5:XAR4 = ACC:P
MOVL   @XAR5,ACC
MOVL   XT,@M1           ; XT = M1
QMPYXUL P,XT,@X0        ; P = high 32-bits of (sign M1 * uns X0)
MOV    @T,#32           ; T = 32
LSL64  ACC:P,T          ; ACC:P = ACC:P << T
ASR64  ACC:P,T          ; ACC:P = ACC:P >> T
MOVL   @XAR6,P          ; XAR7:XAR6 = ACC:P
MOVL   @XAR7,ACC
IMPYLL P,XT,@X1         ; P = low 32-bits of (sign M1 * sign X1)
QMPYLL ACC,XT,@X1       ; ACC = high 32-bits of (sign M1 * sign X1)
ADDUL  P,@XAR4          ; ACC:P = ACC:P + XAR5:XAR4
ADDCL  ACC,@XAR5
ADDUL  P,@XAR6          ; ACC:P = ACC:P + XAR7:XAR6
ADDCL  ACC,@XAR7
ADDUL  P,@B0            ; ACC:P = ACC:P + B64
ADDCL  ACC,@B1
MOVL   @Y0,P            ; Store result into Y64
MOVL   @Y1,ACC

```

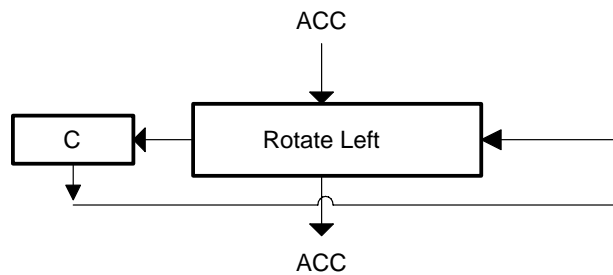
**ROL ACC**

*Rotate Accumulator Left*

SYNTAX OPTIONS	OPCODE	OBJMODE	RPT	CYC
ROL ACC	1111 1111 0101 0011	X	Y	N+1

**Operands**    **ACC**    Accumulator register

**Description**                    Rotate the content of the ACC register left by one bit, filling bit 0 with the content of the carry flag and loading the carry flag with the bit shifted out:



- Flags and Modes**
- N**    After the operation, the N flag is set if bit 31 of the ACC is 1, else N is cleared.
  - Z**    After the operation, the Z flag is set if the ACC is zero, else Z is cleared.
  - C**    The value in bit 31 of the ACC register is transferred to C. The value in C before the rotation is transferred to bit 0 of the ACC.

**Repeat**                            This instruction is repeatable. If the operation follows a RPT instruction, then the ROL instruction will be executed N+1 times. The state of the Z, N, and C flags will reflect the final result.

**Example**

```

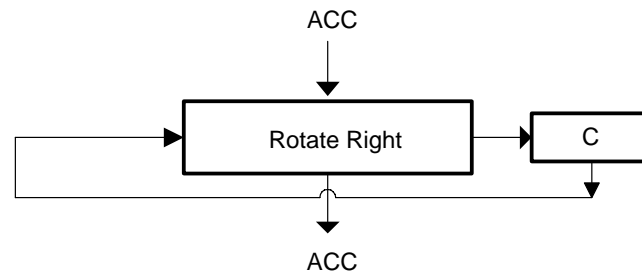
; Rotate contents of VarA left by 5:
MOVL  ACC,@VarA      ; ACC = VarA
RPT   #4              ; Repeat next instruction 5 times
|ROL  ACC             ; Rotate ACC left
MOVL  @VarA,ACC      ; Store result into VarA
  
```

**ROR ACC***Rotate Accumulator Right*

SYNTAX OPTIONS	OPCODE	OBJMODE	RPT	CYC
ROR ACC	1111 1111 0101 0010	X	Y	N+1

**Operands**    **ACC**    Accumulator register

**Description**                    Rotate the content of the ACC register right by one bit, filling bit 31 with the content of the carry flag and loading the carry flag with the bit shifted out:



**Flags and Modes**    **N**            After the operation, the N flag is set if bit 31 of the ACC is 1, else N is cleared.

**Z**                    After the operation, the Z flag is set if the ACC is zero, else Z is cleared.

**C**                    The value in bit 0 of the ACC register is transferred to C. The value in C before the rotation is transferred to bit 31 of the ACC.

**Repeat**                    This instruction is repeatable. If the operation follows a RPT instruction, then the ROR instruction will be executed N+1 times. The state of the Z, N, and C flags will reflect the final result.

**Example**                    ; Rotate contents of VarA right by 5:  
                   MOVL    ACC,@VarA                    ; ACC = VarA  
                   RPT     #4                    ; Repeat next instruction 5 times  
                   | | ROR    ACC                    ; Rotate ACC right  
                   MOVL    @VarA,ACC                    ; Store result into VarA

**RPT #8bit/loc16***Repeat Next Instruction*

SYNTAX OPTIONS	OPCODE	OBJMODE	RPT	CYC
RPT #8bit	1111 0110 CCCC CCCC	X	-	1
RPT loc16	1111 0111 LLLL LLLL	X	-	4

**Operands**    **#8bit**    8-bit constant immediate value (0 to 255 range)  
                  **loc16**    Addressing mode (see Chapter 5)

**Description**            Repeat the next instruction. An internal repeat counter (RPTC) is loaded with a value N that is either the specified #8bit constant value or the content of the location pointed to by the "loc16" addressing mode. After the instruction that follows the RPT is executed once, it is repeated N times; that is, the instruction following the RPT executes N + 1 times. Because the RPTC cannot be saved during a context switch, repeat loops are regarded as multicycle instructions and are not interruptible.

Note on syntax:

Parallel bars (||) before the repeated instruction are used as a reminder that the instruction is repeated and is not interruptible.

When writing inline assembly, use the syntax

```
asm(||     RPT #8bt/ loc16 || instruction");
```

Not all instructions are repeatable. If an instruction that is not repeatable follows the RPT instruction, the RPTC counter is reset to 0 and the instruction only executes once. The 28x Assembly Language tools check for this condition and issue warnings.

**Flags and Modes**            None

**Repeat**                    This instruction is not repeatable. If this instruction follows the RPT instruction, it resets the repeat counter (RPTC) and executes only once.

**Example**

```
; Copy the number of elements specified in VarA from Array1
; to Array2:
; int16 Array1[N]; // Located in high 64K of program space
; int16 Array2[N]; // Located in data space
; for(i=0; i < VarA; i++)
; Array2[i] = Array1[i];
   MOVL   XAR2,#Array2      ; XAR2 = pointer to Array2
   RPT    @VarA             ; Repeat next instruction
                               ; [VarA] + 1 times
   || XPREAD                ; Array2[i] = Array1[i],
 *XAR2++,*(Array1)         ; i++
```

**SAT ACC***Saturate Accumulator*

SYNTAX OPTIONS	OPCODE	OBJMODE	RPT	CYC
SAT ACC	1111 1111 0101 0111	X	-	1

**Operands**    **ACC**    Accumulator register

**Description**                    Saturate the ACC register to reflect the net overflow represented in the 6-bit overflow counter (OVC):

```

if( OVC > 0 )
    ACC = 0x7FFF FFFF;
    V = 1;
if( OVC < 0 )
    ACC = 0x8000 0000;
    V = 1;
if( OVC = 0 )
    ACC = unchanged;
    OVC = 0;
    V = 0;

```

**Flags and Modes**

**N**            After the operation, the N flag is set if bit 31 of the ACC is 1, else N is cleared.

**Z**            After the operation, the Z flag is set if the ACC is zero, else Z is cleared.

**C**            C is cleared.

**V**            If (OVC != 0) at the start of the operation, V is set; otherwise, V is cleared

**OVC**          If (OVC > 0) then ACC is saturated to its maximum positive value.  
                   If (OVC < 0) then ACC is saturated to its maximum negative value.  
                   if (OVC = 0) then ACC is not modified.  
                   After the operation, OVC is cleared.

**Repeat**                            This instruction is not repeatable. If this instruction follows the RPT instruction, it resets the repeat counter (RPTC) and executes only once.

**Example**                            ; Add VarA, VarB and VarC and saturate result and store in VarD:

```

ZAP        OVC                            ; Clear overflow counter
MOVL      ACC,@VarA                      ; Load ACC with contents of VarA
ADDL      ACC,@VarB                      ; Add to ACC contents of VarB
ADDL      ACC,@VarC                      ; Add to ACC contents of VarC
SAT        ACC                            ; Saturate ACC based on OVC value
MOVL      @VarD,ACC                      ; Store result into VarD

```

**SAT64 ACC:P***Saturate 64-bit Value ACC:P*

SYNTAX OPTIONS	OPCODE	OBJMODE	RPT	CYC
SAT64 ACC:P	0101 0110 0011 1110	1	-	1

**Operands**    **ACC:P**    Accumulator register (ACC) and product register (P)

**Description**                    Saturate the 64-bit content of the combined ACC:P registers to reflect the net overflow represented in the overflow counter (OVC):

```

if(OVC > 0)
  ACC:P = 0x7FFF FFFF FFFF FFFF;
  V=1;
if(OVC < 0)
  ACC:P = 0x8000 0000 0000 0000;
  V=1;
if(OVC = 0)
  ACC:P = unchanged;
OVC = 0;

```

**Flags and Modes**

- N**            After the shift, if bit 31 of the ACC register is 1 then ACC:P is negative and the N bit is set; otherwise N is cleared.
- Z**            After the operation, the Z flag is set if the combined 64-bit value of the ACC:P is zero; otherwise, Z is cleared.
- C**            The C bit is cleared.
- V**            At the start of the operation, if (OVC = 0) then V is cleared; otherwise, V is set.
- OVC**        If (OVC = 0), then no saturation takes place:  
ACC:P is unchanged.  
If(OVC > 0), then saturate ACC:P the maximum positive value:  
ACC:P = 0x7FFF FFFF FFFF FFFF  
If( OVC < 0), then saturate ACC:P to the maximum negative value:  
ACC = 0x8000 0000 or ACC:P = 0x8000 0000 0000 0000  
At the end of the operation, OVC is cleared.

**Repeat**

This instruction is not repeatable. If this instruction follows the RPT instruction, it resets the repeat counter (RPTC) and executes only once.

---

**Example** ; Add 64-bit VarA, VarB and VarC, sat and store result in VarD:

```
ZAP OVC ; Clear overflow counter
MOVL P,@VarA+0 ; Load P with low 32-bits of VarA
ADDUL P,@VarB+0 ; Add to P unsigned low 32-bits of VarB
ADDUL P,@VarC+0 ; Add to P unsigned low 32-bits of VarC
MOVU @AL,OVC ; Store overflow (repeated carry) in the ACC
; and then add higher portion of the 64 bit
; variables

MOVB AH,#0 ; Store overflow (repeated carry) in the ACC
; and then add higher portion of the 64 bit
; variables

ZAP OVC ; Clear overflow counter
ADDL ACC,@VarA+2 ; Add to ACC with carry high 32-bits of VarA
ADDL ACC,@VarB+2 ; Add to ACC with carry high 32-bits of VarB
ADDL ACC,@VarC+2 ; Add to ACC with carry high 32-bits of VarC
SAT64 ACC:P ; Saturate ACC:P based on OVC value
MOVL @VarD+0,P ; Store low 32-bit result into VarD
MOVL @VarD+2,ACC ; Store high 32-bit result into VarD
```



**SB 8bitOffset,COND**

SYNTAX OPTIONS	OPCODE	OBJMODE	RPT	CYC
SB 8bitOffset,COND	0110 COND CCCC CCCC	X	-	7/4

<b>Operands</b>	<b>8bitOffset</b>	8-bit signed immediate constant offset value (-128 to +127 range)		
	<b>COND</b>	Conditional codes:		
		COND	Syntax Description	Flags Tested
		0000	NEQ Not Equal To	Z = 0
		0001	EQ Equal To	Z = 1
		0010	GT Greater Than	Z = 0 AND N = 0
		0011	GEQ Greater Than Or Equal To	N = 0
		0100	LT Less Than	N = 1
		0101	LEQ Less Than Or Equal To	Z = 1 OR N = 1
		0110	HI Higher	C = 1 AND Z = 0
		0111	HIS, C Higher Or Same, Carry Set	C = 1
		1000	LO, NC Lower, Carry Clear	C = 0
		1001	LOS Lower Or Same	C = 0 OR Z = 1
		1010	NOV No Overflow	V = 0
		1011	OV Overflow	V = 1
		1100	NTC Test Bit Not Set	TC = 0
		1101	TC Test Bit Set	TC = 1
		1110	NBIO BIO Input Equal To Zero	BIO = 0
		1111	UNC Unconditional	-

**Description** Short conditional branch. If the specified condition is true, then branch by adding the signed 8-bit constant value to the current PC value; otherwise continue execution without branching:

If (COND = true) PC = PC + signed 8-bit offset;  
 If (COND = false) PC = PC + 1;

**Note:** If (COND = true) then the instruction takes 7 cycles.  
 If (COND = false) then the instruction takes 4 cycles.  
 If (COND = UNC) then the instruction takes 4 cycles.

**Flags and Modes** **V** If the V flag is tested by the condition, then V is cleared.

**Repeat** This instruction is not repeatable. If this instruction follows the RPT instruction, it resets the repeat counter (RPTC) and executes only once.

**SBBU ACC,loc16***Subtract Unsigned Value Plus Inverse Borrow*

SYNTAX OPTIONS	OPCODE	OBJMODE	RPT	CYC
SBBU ACC,loc16	0001 1101 LLLL LLLL	X	-	1

**Operands**

**ACC** Accumulator register

**loc16** Addressing mode (see Chapter 5)

**Description**

Subtract the 16-bit contents of the location pointed to by the “loc16” addressing mode, zero extended, and subtract the compliment of the carry flag bit from the ACC register:

$$ACC = ACC - 0:[loc16] - \sim C;$$

**Flags and Modes**

**Z** After the subtraction, the Z flag is set if ACC is zero, else Z is cleared.

**N** After the subtraction, the N flag is set if bit 31 of the ACC is 1, else N is cleared.

**C** The state of the carry bit before execution is included in the subtraction. If the subtraction generates a borrow, C is cleared; otherwise C is set.

**V** If an overflow occurs, V is set; otherwise V is not affected.

**OVC** If(OVM = 0, disabled) then if the operation generates a positive overflow, then the counter is incremented and if the operation generates a negative overflow, then the counter is decremented. If(OVM = 1, enabled) then the counter is not affected by the operation.

**OVM** If overflow mode bit is set; then the ACC value will saturate maximum positive (0x7FFFFFFF) or maximum negative (0x80000000) if the operation overflowed.

**Repeat**

This instruction is not repeatable. If this instruction follows the RPT instruction, it resets the repeat counter (RPTC) and executes only once.

**Example**

```
; Subtract three 32-bit unsigned variables by 16-bit parts:
MOVU ACC,@VarALow          ; AH = 0, AL = VarALow
ADD ACC,@VarAhigh << 16   ; AH = VarAhigh, AL = VarALow
SUBU ACC,@VarBlow         ; ACC = ACC - 0:VarBlow
SUB ACC,@VarBhigh << 16   ; ACC = ACC - VarBhigh << 16
SBBU ACC,@VarClow        ; ACC = ACC - VarClow - ~Carry
SUB ACC,@VarChigh << 16   ; ACC = ACC - VarChigh << 16
```

**SBF 8bitOffset,EQ/NEQ/TC/NTC**

*Short Branch Fast*

SYNTAX OPTIONS	OPCODE	OBJMODE	RPT	CYC
SBF 8bitOffset,EQ	1110 1100 CCCC CCCC	1	–	4/4
SBF 8bitOffset,NEQ	1110 1101 CCCC CCCC	1	–	4/4
SBF 8bitOffset,TC	1110 1110 CCCC CCCC	1	–	4/4
SBF 8bitOffset,NTC	1110 1111 CCCC CCCC	1	–	4/4

**Operands**    **8bitOffset**    8-bit signed immediate constant offset value (–128 to +127 range)

Syntax	Description	Flags Tested
NEQ	Not Equal To	Z = 0
EQ	Equal To	Z = 1
NTC	Test Bit Not Set	TC = 0
TC	Test Bit Set	TC = 1

**Description**

Short fast conditional branch. If the specified condition is true, then branch by adding the signed 8-bit constant value to the current PC value; otherwise continue execution without branching:

```
If (tested condition = true) PC = PC + signed 8-bit off-
set;
If (tested condition = false) PC = PC + 1;
```

**Note:** The short branch fast (SBF) instruction takes advantage of dual pre-fetch queue on the C28x core that reduces the cycles for a taken branch from 7 to 4:

If (tested condition = true) then the instruction takes 4 cycles.  
 If (tested condition = false) then the instruction takes 4 cycles.

**Flags and Modes**

None

**Repeat**

This instruction is not repeatable. If this instruction follows the RPT instruction, it resets the repeat counter (RPTC) and executes only once.

**SBRK #8bit***Subtract From Current Auxiliary Register*

SYNTAX OPTIONS	OPCODE	OBJMODE	RPT	CYC
SBRK,#8bit	1111 1101 CCCC CCCC	X	-	1

**Operands**    **#8bit**    8-bit constant immediate value

**Description**                      Subtract the 8-bit unsigned constant from the XARn register pointed to by ARP:

$$XAR(ARP) = XAR(ARP) - 0:8bit;$$

**Flags and Modes**    **ARP**                      The 3-bit ARP points to the current valid auxiliary register, XAR0 to XAR7. This pointer determines which auxiliary register is modified by the operation.

**Repeat**                              This instruction is not repeatable. If this instruction follows the RPT instruction, it resets the repeat counter (RPTC) and executes only once

**Example**

```

.word 0xEEEE
.word 0x0000
TableA: .word 0x1111
        .word 0x2222
        .word 0x3333
        .word 0x4444

FuncA:
    MOVL  XAR1,#TableA    ; Initialize XAR1 pointer
    MOVZ  AR2,*XAR1       ; Load AR2 with the 16-bit value
                                ; pointed to by XAR1 (0x1111)
                                ; Set ARP = 1

    SBRK  #2              ; Decrement XAR1 by 2
    MOVZ  AR3,*XAR1       ; Load AR3 with the 16-bit value
                                ; pointed to by XAR1 (0xEEEE)

```

**SETC Mode***Set Multiple Status Bits*

SYNTAX OPTIONS	OPCODE	OBJMODE	RPT	CYC
SETC Mode	0011 1011 CCCC CCCC	X	–	1,2
SETC SXM	0011 1011 0000 0001	X	–	1
SETC OVM	0011 1011 0000 0010	X	–	1
SETC TC	0011 1011 0000 0100	X	–	1
SETC C	0011 1011 0000 1000	X	–	1
SETC INTM	0011 1011 0001 0000	X	–	2
SETC DBGM	0011 1011 0010 0000	X	–	2
SETC PAGE0	0011 1011 0100 0000	X	–	1
SETC VMAP	0011 1011 1000 0000	X	–	1

**Operands**    **Mode**    8-bit immediate mask (0x00 to 0xFF)

**Description**                    Set the specified status bits. The "mode" operand is a mask value that relates to the status bits in this way:

"Mode" bit	Status Register	Flag	Cycles
0	ST0	SXM	1
1	ST0	OVM	1
2	ST0	TC	1
3	ST0	C	1
4	ST1	INTM	2
5	ST1	DBGM	2
6	ST1	PAGE0	1
7	ST1	VMAP	1

**Note:** The assembler will accept any number of flag names in any order. For example:

```
SETC INTM,TC           ; Set INTM and TC bits to 1
SETC TC,INTM,OVM,C    ; Set TC, INTM, OVM, C bits to 1
```

**Flags and Modes**

**SXM**    Any of the specified bits can be set by the instruction.

**OVM**

**TC**

**C**

**INTM**

**DBGM**

**PAGE0**

**VMAP**

**Repeat**                            This instruction is not repeatable. If this instruction follows the RPT instruction, it resets the repeat counter (RPTC) and executes only once

**Example**     ; Modify flag settings:

```
SETC  INTM,DBGM      ; Set INTM and DBGM bits to 1
CLRC  TC,C,SXM,OVM  ; Clear TC, C, SXM, OVM bits to 0
CLRC  #0xFF         ; Clear all bits to 0
SETC  #0xFF         ; Set all bits to 1
SETC  C,SXM,TC,OVM  ; Set TC, C, SXM, OVM bits to 1
CLRC  DBGM,INTM     ; Clear INTM and DBGM bits to 0
```

**SETC M0M1MAP***Set the M0M1MAP Status Bit*

SYNTAX OPTIONS	OPCODE	OBJMODE	RPT	CYC
SETC M0M1MAP	0101 0110 0001 1010	X	-	5

**Operands**    **M0M1MAP**    Status bit

**Description**                      Set the M0M1MAP status bit, configuring the mapping of the M0 and M1 memory blocks for C28x/C2XLP operation. The memory blocks are mapped as follows:

M0M1MAP bit	Data Space	Program Space
0 (C27x)	M0: 0x000 to 0x3FF M1: 0x400 to 0x7FF	M0: 0x400 to 0x7FF M1: 0x000 to 0x3FF
1 (C28x/C2XLP)		M0: 0x000 to 0x3FF M1: 0x400 to 0x7FF

**Note:** The pipeline is flushed when this instruction is executed.

**Flags and Modes**    **M0M1MAP**    The M0M1MAP bit is set.

**Repeat**                              This instruction is not repeatable. If this instruction follows the RPT instruction, it resets the repeat counter (RPTC) and executes only once.

**Example**                              ; Set the device mode from reset to C28x:  
Reset:  
    SETC   OBJMODE            ; Enable C28x Object Mode  
    CLRC   AMODE             ; Enable C28x Address Mode  
    .c28\_amode               ; Tell assembler we are in C28x address mode  
    SETC   M0M1MAP           ; Enable C28x Mapping Of M0 and M1 blocks  
    .  
    .

**SETC OBJMODE***Set the OBJMODE Status Bit*

SYNTAX OPTIONS	OPCODE	OBJMODE	RPT	CYC
SETC OBJMODE	0101 0110 0001 1111	X	-	5

**Operands**    **OBJMODE**    Status bit

**Description**                    Set the OBJMODE status bit, putting the device in C28x object mode (supports C2XLP source):

**Flags and**    **OBJMODE**    Set the OBJMODE bit.

**Modes**

**Repeat**                            This instruction is not repeatable. If this instruction follows the RPT instruction, it resets the repeat counter (RPTC) and executes only once.

**Example**                    ; Set the device mode from reset to C28x:

```
Reset:
    SETC  OBJMODE      ; Enable C28x Object Mode
    CLRC  AMODE        ; Enable C28x Address Mode
    .c28_ amode        ; Tell assembler we are in C28x address mode
    SETC  M0M1MAP     ; Enable C28x Mapping Of M0 and M1 blocks
    .
    .
```



**SETC XF***Set XF Bit and Output Signal*

SYNTAX OPTIONS	OPCODE	OBJMODE	RPT	CYC
SETC XF	0101 0110 0010 0110	X	-	1

**Operands**    XF        Status bit and output signal

**Description**                Set the XF status bit and pull the corresponding output signal high.

**Flags and Modes**    XF        The XF status bit is set.

**Repeat**                        This instruction is not repeatable. If this instruction follows the RPT instruction, it resets the repeat counter (RPTC) and executes only once.

**Example**                    ; Pulse XF signal high if branch not taken:

```

MOV   AL,@VarA           ; Load AL with contents of VarA
SB    Dest,NEQ           ; ACC = VarA
SETC  XF                 ; Set XF bit and signal high
CLRC  XF                 ; Clear XF bit and signal low
      .
      .
Dest: .
```

**SFR ACC,#1..16***Shift Accumulator Right*

SYNTAX OPTIONS	OPCODE	OBJMODE	RPT	CYC
SFR ACC,#1..16	1111 1111 0100 SHFT	X	Y	N+1

**Operands**    **ACC**    Accumulator register  
                  **#1..16**    Shift value

**Description**            Right shift the content of the ACC register by the amount specified in the shift field. The type of shift (arithmetic or logical) is determined by the state of the sign extension mode (SXM) bit:

```
if (SXM = 1)                            // sign extension mode enabled
  ACC = S:ACC >> shift value; // arithmetic shift right
else                                    // sign extension mode disabled
  ACC = 0:ACC >> shift value; // logical shift right
```

**Flags and Modes**

**Z**            After the shift, the Z flag is set if the ACC value is zero, else Z is cleared.

**N**            After the shift, the N flag is set if bit 31 of the ACC is 1, else N is cleared.

**C**            The last bit shifted out is loaded into the C flag bit.

**SXM**          If (SXM = 1), then the operation behaves like an arithmetic right shift.  
 If (SXM = 0), then the operation behaves like a logical right shift.

**Repeat**                    This instruction is repeatable. If the operation follows a RPT instruction, then the SFR instruction will be executed N+1 times. The state of the Z, N and C flags will reflect the final result.

**Example**            ; Arithmetic shift right contents of VarA by 10:

```
MOVL    ACC,@VarA                    ; ACC = VarA
SETC    SXM                            ; Enable sign extension mode
SFR     ACC,#10                        ; Arithmetic shift right ACC by 10
MOVL    @VarA,ACC                     ; Store result into VarA
```

**SFR ACC,T***Shift Accumulator Right*

SYNTAX OPTIONS	OPCODE	OBJMODE	RPT	CYC
SFR ACC,T	1111 1111 0101 0001	X	Y	N+1

**Operands**

**ACC** Accumulator register

**T** Upper 16-bits of the multiplicand (XT) register

**Description** Right shift the content of the ACC register by the amount specified in the four least significant bits of the T register, T(3:0) = 0..15. Higher order bits are ignored. The type of shift (arithmetic or logical) is determined by the state of the sign extension mode (SXM) bit:

```

if(SXM = 1)           // sign extension mode enabled
  ACC = S:ACC >> T(3:0); // arithmetic shift right
else                 // sign extension mode disabled
  ACC = 0:ACC >> T(3:0); // logical shift right

```

**Flags and Modes**

**Z** After the shift, the Z flag is set if the ACC value is zero, else Z is cleared. Even if the T register specifies a shift of 0, the content of the ACC register is still tested for the zero condition and Z is affected.

**N** After the shift, the N flag is set if bit 31 of the ACC is 1, else N is cleared. Even if the T register specifies a shift of 0, the content of the ACC register is still tested for the negative condition and N is affected.

**C** If (T(3:0) = 0) then C is cleared; otherwise, the last bit shifted out is loaded into the C flag bit.

**SXM** if (SXM = 1), then the operation behaves like an arithmetic right shift.  
If (SXM = 0), then the operation behaves like a logical right shift.

**Repeat** This instruction is repeatable. If the operation follows a RPT instruction, then the SFR instruction will be executed N+1 times. The state of the Z, N and C flags will reflect the final result.

**Example**

```

; Arithmetic shift right contents of VarA by VarB:
MOVL  ACC,@VarA      ; ACC = VarA
MOV   T,@VarB        ; T = VarB (shift value)
SETC  SXM            ; Enable sign extension mode
SFR   ACC,T          ; Arithmetic shift right ACC by T(3:0)
MOVL  @VarA,ACC      ; Store result into VarA

```

**SPM shift***Set Product Mode Shift Bits*

SYNTAX OPTIONS	OPCODE	OBJMODE	RPT	CYC
SPM +1	1111 1111 0110 1000	X	–	1
SPM 0	1111 1111 0110 1001	X	–	1
SPM –1	1111 1111 0110 1010	X	–	1
SPM –2	1111 1111 0110 1011	X	–	1
SPM –3	1111 1111 0110 1100	X	–	1
SPM –4 (Valid only when AMODE = 0) SPM +4 (Valid only when AMODE = = 1)	1111 1111 0110 1101	X	–	1
SPM –5	1111 1111 0110 1110	X	–	1
SPM –6	1111 1111 0110 1111	X	–	1

**Operands**    **shift**    Product shift mode (+4, +1, 0, –1, –2, –3, –4, –5, –6)

**Description**    Specify a product shift mode. A negative value indicates an arithmetic right shift; positive numbers indicate a logical left shift. The following table shows the relationship between the “shift” operand and the 3-bit value that gets loaded into the product shift mode (PM) bits in ST0. The address mode bit (AMODE) selects between two types of shift decodes as shown in the table below:

PM Bits	AMODE = 1	AMODE = 0
000	SPM +1	SPM +1
001	SPM 0	SPM 0
010	SPM –1	SPM –1
011	SPM –2	SPM –2
100	SPM –3	SPM –3
101	SPM +4	SPM –4
110	SPM –5	SPM –5
111	SPM –6	SPM –6

**Flags and Modes**    **PM**    PM is loaded with the 3-bit value specified by the selected “shift” value.

**Repeat**    This instruction is not repeatable. If the operation follows a RPT instruction, it resets the repeat counter (RPTC) and executes once.

**Example** ; Calculate:  $Y32 = M16 * X16 \gg 4 + B32$

```
CLRC  AMODE                ; Make sure AMODE = 0
SPM   -4                    ; Set product shift mode to ">> 4"
MOV   T,@X16                ; T = X16
MPY   P,XT,@M16             ; P = X16*M16
MOVL  ACC,@B32              ; ACC = B32
ADDL  ACC,P << PM           ; ACC = ACC + (P >> 4)
MOVL  @Y32,ACC              ; Store result into Y32
```

**SQRA loc16***Square Value and Add P to ACC*

SYNTAX OPTIONS	OPCODE	OBJMODE	RPT	CYC
SQRA loc16	0101 0110 0001 0101 0000 0000 LLLL LLLL	1	Y	N+1

**Operands**    **loc16**    Addressing mode (see Chapter 5)

**Description**            Add the previous product (stored in the P register), shifted by the amount specified by the product shift mode (PM), to the ACC register. Then the content of the location pointed to by the "loc16" addressing mode is loaded into the T register, squared, and stored in the P register:

```
ACC = ACC + P << PM;
T = [loc16];
P = T * [loc16];
```

**Flags and Modes**

**Z**            After the addition, the Z flag is set if the ACC value is zero, else Z is cleared.

**N**            After the addition, the N flag is set if bit 31 of the ACC is 1, else N is cleared.

**C**            If the addition generates a carry, C is set; otherwise C is cleared.

**V**            If an overflow occurs, V is set; otherwise V is not affected.

**OVC**        If overflow mode is disabled; and if the operation generates a positive overflow, then the counter is incremented. If overflow mode is disabled; and if the operation generates a negative overflow, then the counter is decremented.

**OVM**        If overflow mode bit is set; then the ACC value will saturate maximum positive (0x7FFFFFFF) or maximum negative (0x80000000) if the operation overflowed.

**PM**         The value in the PM bits sets the shift mode for the output operation from the product register. If the product shift value is positive (logical left shift operation), then the low bits are zero filled. If the product shift value is negative (arithmetic right shift operation), the upper bits are sign extended.

**Repeat**            This instruction is repeatable. If the operation follows a RPT instruction, then it will be executed N+1 times. The state of the Z, N, C and OVC flags will reflect the final result. The V flag is set if an intermediate overflow occurs.

**Example**     ; Calculate sum of squares using 16-bit multiply:  
          ; int16 X[N]       ; Data information  
          ; sum = 0;  
          ; for(i=0; i < N; i++)  
          ;     sum = sum + (X[i] \* X[i]) >> 5;  
          MOVL   XAR2,#X                 ; XAR2 = pointer to X  
          SPM    -5                       ; Set product shift to ">> 5"  
          ZAPA                             ; Zero ACC, P, OVC  
          RPT    #N-1                     ; Repeat next instruction N times  
          | |SQRA \*XAR2++                 ; ACC = ACC + P >> 5,  
  ; P = (\*XAR2++)^2  
          ADDL   ACC,P << PM             ; Perform final accumulate  
          MOVL   @sum,ACC                 ; Store final result into sum

**SQRS loc16***Square Value and Subtract P From ACC*

SYNTAX OPTIONS	OPCODE	OBJMODE	RPT	CYC
SQRS loc16	0101 0110 0001 0001 xxxx xxxx LLLL LLLL	1	Y	N+1

**Operands**    **loc16**    Addressing mode (see Chapter 5)

**Description**                    Subtract the previous product (stored in the P register), shifted by the amount specified by the product shift mode (PM), from the ACC register. Then the content of the location pointed to by the "loc16" addressing mode is loaded into the T register, squared, and stored in the P register:

```
ACC = ACC - P << PM;
T = [loc16];
P = T * [loc16];
```

**Flags and Modes**

**Z**                    After the addition, the Z flag is set if the ACC value is zero, else Z is cleared.

**N**                    After the subtraction, the N flag is set if bit 31 of the ACC is 1, else N is cleared.

**C**                    If the subtraction generates a borrow, C is cleared; otherwise C is set.

**V**                    If an overflow occurs, V is set; otherwise V is not affected.

**OVC**                If overflow mode is disabled; and if the operation generates a positive overflow, then the counter is incremented. If overflow mode is disabled; and if the operation generates a negative overflow, then the counter is decremented.

**OVM**                If overflow mode bit is set; then the ACC value will saturate maximum positive (0x7FFFFFFF) or maximum negative (0x80000000) if the operation overflowed.

**PM**                 The value in the PM bits sets the shift mode for the output operation from the product register. If the product shift value is positive (logical left shift operation), then the low bits are zero filled. If the product shift value is negative (arithmetic right shift operation), the upper bits are sign extended.

**Repeat**                    This instruction is repeatable. If the operation follows a RPT instruction, then it will be executed N+1 times. The state of the Z, N, C and OVC flags will reflect the final result. The V flag will be set if an intermediate overflow occurs.



**Example** ; Calculate sum of negative squares using 16-bit multiply:  
; int16 X[N] ; Data information  
; sum = 0;  
; for(i=0; i < N; i++)  
; sum = sum - (X[i] \* X[i]) >> 5;  
MOVL XAR2,#X ; XAR2 = pointer to X  
SPM -5 ; Set product shift to ">> 5"  
ZAPA ; Zero ACC, P, OVC  
RPT #N-1 ; Repeat next instruction N times  
| |SQRS \*XAR2++ ; ACC = ACC - P >> 5,  
; P = (\*XAR2++)^2  
SUBL ACC,P << PM ; Perform final subtraction  
MOVL @sum,ACC ; Store final result into sum

**SUB ACC,loc16 << #0...16***Subtract Shifted Value From Accumulator*

SYNTAX OPTIONS	OPCODE	OBJMODE	RPT	CYC
SUB ACC,loc16 << #0	1010 1110 LLLL LLLL	1	Y	N+1
	1000 0000 LLLL LLLL	0	-	1
SUB ACC,loc16 << #1..15	0101 0110 0000 0000 0000 SHFT LLLL LLLL	1	Y	N+1
	1000 SHFT LLLL LLLL	0	-	1
SUB ACC,loc16 << #16	0000 0100 LLLL LLLL	X	Y	N+1

**Operands**

**ACC** Accumulator register

**loc16** Addressing mode (see Chapter 5)

**#0..16** Shift value (default is "<< #0" if no value specified)

**Description**

Subtract the left-shifted 16-bit location pointed to by the "loc16" addressing mode from the ACC register. The shifted value is sign extended if sign extension mode is turned on (SXM=1) else the shifted value is zero extended (SXM= 0). The lower bits of the shifted value are zero filled:

```
if(SXM = 1)           // sign extension mode enabled
    ACC = ACC - S:[loc16] << shift value;
else                 // sign extension mode disabled
    ACC = ACC - 0:[loc16] << shift value;
```

**Flags and Modes**

**Z** After the subtraction, the Z flag is set if ACC is zero, else Z is cleared.

**N** After the subtraction, the N flag is set if bit 31 of the ACC is 1, else Z is cleared.

**C** If the subtraction generates a borrow, C is cleared; otherwise C is set.  
**Exception:** If a shift of 16 is used, the SUB instruction can clear C but not set it.

**V** If an overflow occurs, V is set; otherwise V is not affected.

**OVC** If(OVM = 0, disabled) then if the operation generates a positive overflow, then the counter is incremented and if the operation generates a negative overflow, then the counter is decremented. If(OVM = 1, enabled) then the counter is not affected by the operation.

**SXM** If sign extension mode bit is set; then the 16-bit operand, addressed by the "loc16" field, will be sign extended before the addition. Else, the value will be zero extended.

**OVM** If overflow mode bit is set; then the ACC value will saturate maximum positive (0x7FFF FFFF) or maximum negative (0x8000 0000) if the operation overflowed.

**Repeat** If the operation is repeatable, then the instruction will be executed N+1 times. The state of the Z, N, C flags will reflect the final result. The V flag will be set if an intermediate overflow occurs. The OVC flag will count intermediate overflows, if overflow mode is disabled. If the operation is not repeatable, the instruction will execute only once.

**Example**

```
; Calculate signed value: ACC = (VarA << 10) - (VarB << 6);
SETC  SXM                ; Turn sign extension mode on
MOV   ACC,@VarA << #10   ; Load ACC with VarA left shifted by 10
SUB   ACC,@VarB << #6    ; Subtract VarB left shifted by 6 to
                        ACC0
```

**SUB ACC,loc16 <<T***Subtract Shifted Value From Accumulator*

SYNTAX OPTIONS	OPCODE	OBJMODE	RPT	CYC
SUB ACC,loc16 <<T	0101 0110 0010 0111 0000 0000 LLLL LLLL	1	Y	N+1

<b>Operands</b>	<b>ACC</b>	Accumulator register
	<b>loc16</b>	Addressing mode (see Chapter 5)
	<b>T</b>	Upper 16–bits of the multiplicand register, XT(31:16)

**Description** Subtract from the ACC register the left–shifted contents of the 16-bit location pointed to by the “loc16” addressing mode. The shift value is specified by the four least significant bits of the T register, T(3:0) = shift value = 0..15. Higher order bits are ignored. The shifted value is sign extended if sign extension mode is turned on (SXM=1) else the shifted value is zero extended (SXM=0). The lower bits of the shifted value are zero filled:

```
if(SXM = 1)           // sign extension mode enabled
    ACC = ACC - S:[loc16] << T(3:0);
else                 // sign extension mode disabled
    ACC = ACC - 0:[loc16] << T(3:0);
```

<b>Flags and Modes</b>	<b>Z</b>	After the subtraction, the Z flag is set if the ACC value is zero, else Z is cleared.
	<b>N</b>	After the subtraction, the N flag is set if bit 31 of the ACC is 1, else N is cleared.
	<b>C</b>	If the subtraction generates a borrow, C is cleared; otherwise C is set.
	<b>V</b>	If an overflow occurs, V is set; otherwise V is not affected.
	<b>OVC</b>	If(OVM = 0, disabled) then if the operation generates a positive overflow, then the counter is incremented and if the operation generates a negative overflow, then the counter is decremented. If(OVM = 1, enabled) then the counter is not affected by the operation.
	<b>SXM</b>	If sign extension mode bit is set; then the 16-bit operand, addressed by the “loc16” field, will be sign extended before the addition. Else, the value will be zero extended.
	<b>OVM</b>	If overflow mode bit is set; then the ACC value will saturate maximum positive (0x7FFF FFFF) or maximum negative (0x8000 0000) if the operation overflowed.

**Repeat** If this operation is repeated, then the instruction will be executed N+1 times. The state of the Z, N, C flags will reflect the final result. The V flag will be set if an intermediate overflow occurs. The OVC flag will count intermediate overflows, if overflow mode is disabled.

**Example**       ; Calculate signed value: ACC = (VarA << SB) - (VarB << SB)  
SETC SXM                               ; Turn sign extension mode on  
MOV T,@SA                              ; Load T with shift value in SA  
MOV ACC,@VarA << T                    ; Load in ACC shifted contents of VarA  
MOV T,@SB                              ; Load T with shift value in SB  
SUB ACC,@VarB << T                    ; Subtract from ACC shifted contents  
                                      ; of VarB

**SUB ACC,#16bit << #0..15***Subtract Shifted Value From Accumulator*

SYNTAX OPTIONS	OPCODE	OBJMODE	RPT	CYC
SUB ACC,#16bit << #0..15	1111 1111 0000 SHFT CCCC CCCC CCCC CCCC	X	-	1

**Operands**

**ACC** Accumulator register

**#16bit** 16-bit immediate constant value

**#0..15** Shift value (default is "<< #0" if no value specified)

**Description**

Subtract the left shifted 16-bit immediate constant value from the ACC register. The shifted value is sign extended if sign extension mode is turned on (SXM=1) else the shifted value is zero extended (SXM=0). The lower bits of the shifted value are zero filled:

```
if(SXM = 1)          // sign extension mode enabled
    ACC = ACC - S:16bit << shift value;
else                // sign extension mode disabled
    ACC = ACC - 0:16bit << shift value;
```

**Smart Encoding:**

If #16bit is an 8-bit number and the shift is zero, then the assembler will encode this instruction as SUBB ACC, #8bit for improved efficiency. To override this encoding, use the SUBW ACC, #16bit instruction alias.

**Flags and Modes**

**Z** After the subtraction, the Z flag is set if ACC is zero, else Z is cleared.

**N** After the subtraction, the N flag is set if bit 31 of the ACC is 1, else N is cleared.

**C** If the subtraction generates a borrow, C is cleared; otherwise C is set.

**V** If an overflow occurs, V is set; otherwise V is not affected.

**OVC** If(OVM = 0, disabled) then if the operation generates a positive overflow, then the counter is incremented and if the operation generates a negative overflow, then the counter is decremented. If(OVM = 1, enabled) then the counter is not affected by the operation.

**SXM** If sign extension mode bit is set; then the 16-bit operand, addressed by the "loc16" field, will be sign extended before the addition. Else, the value will be zero extended.

**OVM** If overflow mode bit is set; then the ACC value will saturate maximum positive (0x7FFFFFFF) or maximum negative (0x80000000) if the operation overflowed.

**Repeat**

This instruction is not repeatable. If this instruction follows the RPT instruction, it resets the repeat counter (RPTC) and executes only once.

**Example**

```
; Calculate signed value: ACC = (VarB << 10) - (23 << 6);
SETC  SXM                ; Turn sign extension mode on
MOV   ACC,@VarB << #10   ; Load ACC with VarB left shifted by 10
SUB   ACC,#23 << #6      ; Subtract from ACC 23 left shifted by 6
```

**SUB AX, loc16***Subtract Specified Location From AX*

SYNTAX OPTIONS	OPCODE	OBJMODE	RPT	CYC
SUB AX, loc16	1001 111A LLLL LLLL	X	-	1

**Operands**    **AX**        Accumulator high (AH) or accumulator low (AL) register  
                   **loc16**        Addressing mode (see Chapter 5)

**Description**        Subtract the 16-bit content of the location pointed to by the "loc16" addressing mode from the specified AX register (AH or AL) and store the results in AX:

$AX = AX - [loc16];$

**Flags and Modes**

**N**        After the subtraction, AX is tested for a negative condition. If bit 15 of AX is 1, then the negative flag bit is set; otherwise it is cleared.

**Z**        After the subtraction, AX is tested for a zero condition. The zero flag bit is set if the operation generates  $AX = 0$ , otherwise it is cleared

**C**        If the subtraction generates a borrow, C is cleared; otherwise C is set.

**V**        If an overflow occurs, V is set; otherwise V is not affected. Signed positive overflow occurs if the result crosses the max positive value (0x7FFF) in the positive direction. Signed negative overflow occurs if the result crosses the max negative value (0x8000) in the negative direction.

**Repeat**                This instruction is not repeatable. If this instruction follows the RPT instruction, it resets the repeat counter (RPTC) and executes only once.

**Example**                ; Subtract the contents of VarA with VarB and store in VarC  
 MOV    AL,@VarA                                ; Load AL with contents of VarA  
 SUB    AL,@VarB                                ; Subtract from AL contents of VarB  
 MOV    @VarC,AL                                ; Store result in VarC

**SUB loc16, AX***Reverse-Subtract Specified Location From AX*

SYNTAX OPTIONS	OPCODE	OBJMODE	RPT	CYC
SUB loc16, AX	0111 010A LLLL LLLL	X	-	1

**Operands**    **loc16**    Addressing mode (see Chapter 5)  
                   **AX**        Accumulator high (AH) or accumulator low (AL) register

**Description**            Subtract the content of the specified AX register (AH or AL) from the 16-bit content of the location pointed to by the "loc16" addressing mode and store the result in location pointed to by "loc16":

[loc16] = [loc16] - AX;

**Flags and Modes**    **N**        After the subtraction, [loc16] is tested for a negative condition. If bit 15 of [loc16] is 1, then the negative flag bit is set; otherwise it is cleared.

**Z**        After the subtraction, [loc16] is tested for a zero condition. The zero flag bit is set if the operation generates [loc16] = 0; otherwise it is cleared

**C**        If the subtraction generates a borrow, C is cleared; otherwise C is set.

**V**        If an overflow occurs, V is set; otherwise V is not affected. Signed positive overflow occurs if the result crosses the max positive value (0x7FFF) in the positive direction. Signed negative overflow occurs if the result crosses the max negative value (0x8000) in the negative direction.

**Repeat**                This instruction is not repeatable. If this instruction follows the RPT instruction, it resets the repeat counter (RPTC) and executes only once.

**Example**              ; Subtract the contents of VarA from index register AR0:  
 MOV    AL,@VarA                            ; Load AL with contents of VarA  
 SUB    @AR0,AL                             ; AR0 = AR0 - AL  
 ; Subtract the contents of VarB from VarC:  
 MOV    AH,@VarB                            ; Load AH with contents of VarB  
 SUB    @VarC,AH                             ; VarC = VarC - AH



**SUBB ACC,#8bit**

*Subtract 8-bit Value*

SYNTAX OPTIONS	OPCODE	OBJMODE	RPT	CYC
SUBB ACC,#8bit	0001 1001 cccc cccc	X	-	1

**Operands**    **ACC**    Accumulator register  
                  **#8bit**    8-bit immediate constant value

**Description**                    Subtract the zero-extended, 8-bit constant from the ACC register:  
    ACC = ACC - 0:8bit;

**Flags and Modes**

- Z**            After the subtraction, the Z flag is set if ACC is zero, else Z is cleared.
- N**            After the subtraction, the N flag is set if bit 31 of the ACC is 1, N is cleared.
- C**            If the subtraction generates a borrow, C is cleared; otherwise C is set.
- V**            If an overflow occurs, V is set; otherwise, V is not affected.
- OVC**        If(OVM = 0, disabled) then if the operation generates a positive overflow, then the counter is incremented and if the operation generates a negative overflow, then the counter is decremented. If(OVM = 1, enabled) then the counter is not affected by the operation.
- OVM**        If overflow mode bit is set; then the ACC value will saturate maximum positive (0x7FFFFFFF) or maximum negative (0x80000000) if the operation overflowed.

**Repeat**                            This instruction is not repeatable. If this instruction follows the RPT instruction, it resets the repeat counter (RPTC) and executes only once.

**Example**                    ; Decrement contents of 32-bit location VarA:  
                  MOVL    ACC,@VarA                    ; Load ACC with contents of VarA  
                  SUBB    ACC,#1                        ; Subtract 1 from ACC  
                  MOVL    @VarA,ACC                   ; Store result back into VarA



**SUBB XARn,#7bit**

*Subtract 7-Bit From Auxiliary Register*

SYNTAX OPTIONS	OPCODE	OBJMODE	RPT	CYC
SUBB XARn, #7bit	1101 1nnn 1CCC CCCC	X	-	1

**Operands**    **XARn**    XAR0 to XAR7, 32-bit auxiliary registers  
                  **#7bit**    7-bit immediate constant value

**Description**                Subtract the 7-bit unsigned constant from XARn and store the result in XARn:

$$XARn = XARn - 0:7bit;$$

**Flags and Modes**                None

**Repeat**                        This instruction is not repeatable. If this instruction follows the RPT instruction, it resets the repeat counter (RPTC) and executes only once.

**Example**

```

MOVL XAR1, #VarA                        ; Initialize XAR1 pointer with address
                                          ; of VarA
MOVL XAR2, *XAR1                        ; Load XAR2 with contents of VarA
SUBB XAR2, #10h`                        ; XAR2 = VarA - 0x10
    
```

**SUBBL ACC, loc32***Subtract 32-bit Value Plus Inverse Borrow*

SYNTAX OPTIONS	OPCODE	OBJMODE	RPT	CYC
SUBBL ACC, loc32	0101 0110 0101 0100 0000 0000 LLLL LLLL	1	-	1

**Operands**    **loc32**    Addressing mode (see Chapter 5)

**ACC**    Accumulator register

**Description**                    Subtract from the ACC the 32-bit location pointed to by the “loc32” addressing mode and the logical inversion of the value in the carry flag bit:

$$ACC = ACC - [loc32] - \sim C;$$

**Flags and Modes**    **Z**            After the subtraction, the Z flag is set if the ACC value is zero, else Z is cleared.

**N**            After the subtraction, the N flag is set if bit 31 of the ACC is 1, else N is cleared.

**C**            The state of the carry bit before execution is included in the subtraction. If the subtraction generates a borrow, C is cleared; otherwise C is set.

**V**            If an overflow occurs, V is set; otherwise V is not affected.

**OVC**        If(OVM = 0, disabled) then if the operation generates a positive overflow, then the counter is incremented and if the operation generates a negative overflow, then the counter is decremented. If(OVM = 1, enabled) then the counter is not affected by the operation.

**OVM**        If overflow mode bit is set; then the ACC value will saturate maximum positive (0x7FFFFFFF) or maximum negative (0x80000000) if the operation overflowed.

**Repeat**                            This instruction is not repeatable. If this instruction follows the RPT instruction, it resets the repeat counter (RPTC) and executes only once.

**Example**     ; Subtract two 64-bit values (VarA and VarB) and store result  
              ; in VarC:  
MOVL   ACC,@VarA+0             ; Load ACC with contents of the low  
                                  ; 32-bits of VarA  
SUBUL   ACC,@VarB+0             ; Subtract from ACC the contents of  
                                  ; the low 32-bits of VarB  
MOVL   @VarC+0,ACC             ; Store low 32-bit result into VarC  
MOVL   ACC,@VarA+2             ; Load ACC with contents of the high  
                                  ; 32-bits of VarA  
SUBBL   ACC,@VarB+2             ; Subtract from ACC the contents of  
                                  ; the high 32-bits of VarB with borrow  
MOVL   @VarC+2,ACC             ; Store high 32-bit result into VarC

**SUBCU ACC,loc16***Subtract Conditional 16 Bits*

SYNTAX OPTIONS	OPCODE	OBJMODE	RPT	CYC
SUBCU ACC,loc16	0001 1111 LLLL LLLL	X	Y	N+1

**Operands**    **ACC**    Accumulator register  
                  **loc32**    Addressing mode (see Chapter 5)

**Description**            Perform 16-bit conditional subtraction, which can be used for unsigned modulus division:

```
temp(32:0) = ACC << 1 - [loc16] << 16
if( temp(32:0) >= 0 )
    ACC = temp(31:0) + 1
else
    ACC = ACC << 1
```

To perform 16-bit unsigned modulus division, the AH register is zeroed and the AL register is loaded with the "Numerator" value prior to executing the SUBCU instruction. The value pointed to be the "loc16" addressing mode contains the "Denominator" value. After executing the SUBCU instruction 16 times, the AH register will contain the "Remainder" and the AL register will contain the "Quotient" results. To perform signed modulus division, the "Numerator" and "Denominator" values must be converted to unsigned quantities, before executing the SUBCU instruction. The final "Quotient" result must be negated if the "Numerator" and "Denominator" values were of different sign else the quotient is left unchanged.

**Flags and Modes**    **Z**            At the end of the operation, the Z flag is set if the ACC value is zero, else Z is cleared. The calculation of temp(32:0) has no effect on the Z bit.  
                       **N**            At the end of the operation, the N flag is set if bit 31 of the ACC is 1, else N is cleared. The calculation of temp(32:0) has no effect on the N bit.  
                       **C**            If the calculation of temp(32:0) generates a borrow, C is cleared; otherwise C is set.

**Note:** The V and OVC flags are not affected by the operation.

**Repeat**                    If this operation is repeated, then the instruction will be executed N+1 times. The state of the Z, N, C flags will reflect the final result. The V flag will be set if an intermediate overflow occurs. The OVC flag will count intermediate overflows, if overflow mode is disabled.

**Example 1**            ; Calculate unsigned: Quot16 = Num16Den16, Rem16 = Num16%Den16  
                       MOVU    ACC,@Num16            ; AL = Num16, AH = 0  
                       RPT     #15             ; Repeat operation 16 times  
                       ||SUBCU   ACC,@Den16       ; Conditional subtract with Den16  
                       MOV     @Rem16,AH       ; Store remainder in Rem16  
                       MOV     @Quot16,AL       ; Store quotient in Quot16

**Example 2** ; Calculate signed: Quot16 = Num16/Den16, Rem16 = Num16%Den16

```

CLRC    TC                ; Clear TC flag, used as sign flag
MOV     ACC,@Den16 << 16 ; AH = Den16, AL = 0
ABSTC  ACC                ; Take abs value, TC = sign ^ TC
MOV     T,@AH             ; Temp save Den16 in T register
MOV     ACC,@Num16 << 16 ; AH = Num16, AL = 0
ABSTC  ACC                ; Take abs value, TC = sign ^ TC
MOVU   ACC,@AH           ; AH = 0, AL = Num16
RPT    #15               ; Repeat operation 16 times
|SUBCU  ACC,@T           ; Conditional subtract with Den16
MOV     @Rem16,AH        ; Store remainder in Rem16
MOV     ACC,@AL << 16    ; AH = Quot16, AL = 0
NEGTC  ACC               ; Negate if TC = 1
MOV     @Quot16,AH       ; Store quotient in Quot16

```

**Example 3** ; Calculate unsigned: Quot32 = Num32/Den16, Rem16 = Num32%Den16

```

MOVU   ACC,@Num32+1      ; AH = 0, AL = high 16-bits of Num32
RPT    #15               ; Repeat operation 16 times
|SUBCU  ACC,@Den16      ; Conditional subtract with Den16
MOV     @Quot32+1,AL     ; Store high 16-bit in Quot32
MOV     AL,@Num32+0      ; AL = low 16-bits of Num32
RPT    #15               ; Repeat operation 16 times
|SUBCU  ACC,@Den16      ; Conditional subtract with Den16
MOV     @Rem16,AH        ; Store remainder in Rem16
MOV     @Quot32+0,AL     ; Store low 16-bit in Quot32

```

**Example 4** ; Calculate signed: Quot32 = Num32/Den16, Rem16 = Num32%Den16

```

CLRC    TC                ; Clear TC flag, used as sign flag
MOV     ACC,@Den16 << 16 ; AH = Den16, AL = 0
ABSTC  ACC                ; Take abs value, TC = sign ^ TC
MOV     T,@AH             ; Temp save Den16 in T register
MOVL   ACC,@Num32        ; ACC = Num32
ABSTC  ACC                ; Take abs value, TC = sign ^ TC
MOV     P,@ACC           ; P = Num32
MOVU   ACC,@PH           ; AH = 0, AL = high 16-bits of Num32
RPT    #15               ; Repeat operation 16 times
|SUBCU  ACC,@T           ; Conditional subtract with Den16
MOV     @Quot32+1,AL     ; Store high 16-bit in Quot32
MOV     AL,@PL           ; AL = low 16-bits of Num32
RPT    #15               ; Repeat operation 16 times
|SUBCU  ACC,@T           ; Conditional subtract with Den16
MOV     @Rem16,AH        ; Store remainder in Rem16
MOV     ACC,@AL << 16    ; AH = low 16-bits of Quot32, AL = 0
NEGTC  ACC               ; Negate if TC = 1
MOV     @Quot32+0,AH     ; Store low 16-bit in Quot32

```

**SUBCUL ACC,loc32***Subtract Conditional 32 Bits*

SYNTAX OPTIONS	OPCODE	OBJMODE	RPT	CYC
SUBCUL ACC,loc32	0101 0110 0001 0111 0000 0000 LLLL LLLL	1	Y	N+1

**Operands**    **ACC**    Accumulator register  
                   **loc32**    Addressing mode (see Chapter 5)

**Description**                    Perform 32-bit conditional subtraction, which can be used for unsigned modulus division:

```
temp(32:0) = ACC << 1 + P(31) - [loc32];
if( temp(32:0) >= 0 )
    ACC = temp(31:0);
    P = (P << 1) + 1;
else
    ACC:P = ACC:P << 1;
```

To perform 32-bit unsigned modulus division, the ACC register is zeroed and the P register is loaded with the "Numerator" value prior to executing the SUBCUL instruction. The value pointed to be the "loc32" addressing mode contains the "Denominator" value. After executing the SUBCUL instruction 32 times, the ACC register will contain the "Remainder" and the P register will contain the "Quotient" results. To perform signed modulus division, the "Numerator" and "Denominator" values must be converted to unsigned quantities, before executing the SUBCUL instruction. The final "Quotient" result must be negated if the "Numerator" and "Denominator" values were of different sign else the quotient is left unchanged.

**Flags and Modes**    **Z**            At the end of the operation, the Z flag is set if the ACC value is zero, else Z is cleared. The calculation of temp(32:0) has no effect on the Z bit.

**N**            At the end of the operation, the N flag is set if bit 31 of the ACC is 1, else N is cleared. The calculation of temp(32:0) has no effect on the N bit.

**C**            If the calculation of temp(32:0) generates a borrow, C is cleared; otherwise C is set.

**Note:**    The V and OVC flags are not affected by the operation.

**Repeat**                            If this operation is repeated, then the instruction will be executed N+1 times. The state of the Z, N, C flags will reflect the final result. The V flag will be set if an intermediate overflow occurs. The OVC flag will count intermediate overflows, if overflow mode is disabled.



**Example 1** ; Calculate unsigned: Quot32 = Num32/Den32, Rem32 = Num32%Den32  
MOVB ACC,#0 ; Zero ACC  
MOVL P,@Num32 ; Load P register with Num32  
RPT #31 ; Repeat operation 32 times  
| |SUBCUL ACC,@Den32 ; Conditional subtract with Den32  
MOVL @Rem32,ACC ; Store remainder in Rem32  
MOVL @Quot32,P ; Store quotient in Quot32

**Example 2** ; Calculate signed: Quot32 = Num32/Den32, Rem32 = Num32%Den32  
CLRC TC ; Clear TC flag, used as sign flag  
MOVL ACC,@Den32 ; Load ACC with contents of Den32  
ABSTC ACC ; Take absolute value, TC = sign ^ TC  
MOVL XT,@ACC ; Temp save denominator in XT register  
MOVL ACC,@Num32 ; Load ACC register with Num32  
ABSTC ACC ; Take abs value, TC = sign ^ TC  
MOVL P,@ACC ; Load P register with numerator  
MOVB ACC,#0 ; Zero ACC  
RPT #31 ; Repeat operation 32 times  
| |SUBCUL ACC,@XT ; Conditional subtract with denominator  
MOVL @Rem32,ACC ; Store remainder in Rem32  
MOVL ACC,@P ; Load ACC with quotient  
NEGTC ACC ; Negate ACC if TC=1 (negative result)  
MOVL @Quot32,ACC ; Store quotient in Quot32

**Example 3** ; Calculate unsigned: Quot64 = Num64/Den32, Rem32 = Num64%Den32  
MOVB ACC,#0 ; Zero ACC  
MOVL P,@Num64+2 ; Load P with high 32-bits of Num64  
RPT #31 ; Repeat operation 32 times  
| |SUBCUL ACC,@Den32 ; Conditional subtract with Den32  
MOVL @Quot64+2,P ; Store high 32 bit quotient in Quot64  
MOVL P,@Num64+0 ; Load P with low 32-bits of Num64  
RPT #31 ; Repeat operation 32 times  
| |SUBCUL ACC,@Den32 ; Conditional subtract with Den32  
MOVL @Rem32,ACC ; Store remainder in Rem32  
MOVL @Quot64+0,P ; Store low 32 bit quotient in Quot64

```

Example 4 ; Calculate signed: Quot64 = Num364Den32, Rem32 = Num64%Den32
            MOVL    ACC,@Num64+2      ; Load ACC:P with 64-bit numerator
            MOVL    P,@Num64+0
            TBIT    @AH,#15           ; TC = sign of numerator
            SBF     $10,NTC           ; Take absolute value of numerator
            NEG64   ACC:P
$10:
            MOVL    @XAR3,P           ; Temp save numerator low in XAR3
            MOVL    P,@ACC            ; Load P register with numerator high
            MOVL    ACC,@Den32        ; Load ACC with contents of Den32
            ABSTC   ACC               ; Take absolute value, TC = sign ^ TC
            MOVL    XT,@ACC           ; Temp save denominator in XT register
            MOVB    ACC,#0            ; Zero ACC
            RPT     #31               ; Repeat operation 32 times
            ||SUBCUL ACC,@XT          ; Conditional subtract with denominator
            MOVL    @XAR4,P           ; Store high quotient in XAR4
            MOVL    P,@XAR3          ; Load P with low numerator
            RPT     #31               ; Repeat operation 32 times
            ||SUBCUL ACC,@XT          ; Conditional subtract with denominator
            MOVL    @Rem32,ACC        ; Store remainder in Rem32
            MOVL    ACC,@XAR4         ; Load ACC with high quotient from XAR4
            SBF     $20,NTC           ; Take absolute value of quotient
            NEG64   ACC:P
$20:
            MOVL    @Quot64+0,P       ; Store low quotient into Quot64
            MOVL    @Quot64+2,ACC     ; Store high quotient into Quot64

```

**SUBL ACC, loc32**

*Subtract 32-bit Value*

SYNTAX OPTIONS	OPCODE	OBJMODE	RPT	CYC
SUBL ACC, loc32	0000 0011 LLLL LLLL	1	-	1

**Operands**    **ACC**    Accumulator register  
                  **loc32**    Addressing mode (see Chapter 5)

**Description**                    Subtract the 32-bit location pointed to by the “loc32” addressing mode from the ACC register :

$$ACC = ACC - [loc32];$$

**Flags and Modes**

**Z**            After the subtraction, the Z flag is set if the ACC value is zero, else Z is cleared.

**N**            After the subtraction, the N flag is set if bit 31 of the ACC is 1, else N is cleared.

**C**            If the subtraction generates a borrow, C is cleared; otherwise C is set.

**V**            If an overflow occurs, V is set; otherwise V is not affected.

**OVC**        If OVM = 0 (disabled), then if the operation generates a positive overflow, then the counter is incremented and if the operation generates a negative overflow, then the counter is decremented.  
                  If OVM = 1 (enabled), then the counter is not affected by the operation.

**OVM**        If overflow mode bit is set; then the ACC value will saturate maximum positive (0x7FFFFFFF) or maximum negative (0x80000000) if the operation overflowed.

**Repeat**                            This instruction is not repeatable. If this instruction follows the RPT instruction, it resets the repeat counter (RPTC) and executes only once.

**Example**                    ; Calculate the 32-bit value: VarC = VarA-VarB  
                  MOVL    ACC,@VarA                    ; Load ACC with contents of VarA  
                  SUBL    ACC,@VarB                    ; Subtract from ACC the contents of VarB  
                  MOVL    @VarC,ACC                    ; Store result into VarC

**SUBL ACC,P << PM**

*Subtract 32-bit Value*

SYNTAX OPTIONS	OPCODE	OBJMODE	RPT	CYC
SUBL ACC,P << PM	0001 0001 1010 1100	X	Y	N+1

**Note:** This instruction is an alias for the "MOVS T,loc16" operation with "loc16 = @T" addressing mode.

**Operands**

**ACC** Accumulator register

**P** Product register

**<<PM** Product shift mode

**Description**

Subtract the content of the P register, shifted as specified by the product shift mode (PM), from the content of the ACC register:

$$ACC = ACC - P \ll PM;$$

**Flags and Modes**

**Z** After the subtraction, the Z flag is set if the ACC value is zero, else Z is cleared.

**N** After the subtraction, the N flag is set if bit 31 of the ACC is 1, else N is cleared.

**C** If the subtraction generates a borrow, C is cleared; otherwise C is set.

**V** If an overflow occurs, V is set; otherwise V is not affected.

**OVC** If OVM = 0 (disabled) and the operation generates a positive overflow, the counter is incremented; if the operation generates a negative overflow, the counter is decremented. If OVM = 1 (enabled), the counter is not affected by the operation.

**OVM** If overflow mode bit is set; then the ACC value will saturate maximum positive (0x7FFFFFFF) or maximum negative (0x80000000) if the operation overflowed.

**PM** The value in the PM bits sets the shift mode for the output operation from the product register. If the product shift value is positive (logical left shift operation), then the low bits are zero filled. If the product shift value is negative (arithmetic right shift operation), the upper bits are sign extended.

**Repeat**

If this operation is repeated, then the instruction will be executed N+1 times. The state of the Z, N, C flags will reflect the final result. The V flag will be set if an intermediate overflow occurs. The OVC flag will count intermediate overflows, if overflow mode is disabled.

**Example**     ; Calculate:  $Y = ((B \ll 11) - (M * X \gg 4)) \gg 10$   
              ; Y, M, X, B are Q15 values  
SPM     -4                             ; Set product shift to  $\gg 4$   
SETC   SXM                            ; Enable sign extension mode  
MOV     T,@M                          ; T = M  
MPY     P,T,@X                        ; P = M \* X  
MOV     ACC,@B << 11                 ; ACC = S:B << 11  
SUBL    ACC,P << PM                    ; ACC = (S:B << 11) - (M\*X >> 4)  
MOVH    @Y,ACC << 5                  ; Store Q15 result into Y

**SUBL loc32, ACC**

*Subtract 32-bit Value*

SYNTAX OPTIONS	OPCODE	OBJMODE	RPT	CYC
SUBL loc32, ACC	0101 0110 0100 0001 0000 0000 LLLL LLLL	1	-	1

**Operands**    **loc32**    Addressing mode (see Chapter 5)  
                   **ACC**        Accumulator register

**Description**                Subtract the content of the ACC register from the location pointed to by the “loc32” addressing mode:  
                                        $[loc32] = [loc32] - ACC;$

**Flags and Modes**

- Z**            After the subtraction, the Z flag is set if the ACC value is zero, else Z is cleared.
- N**            After the subtraction, the N flag is set if bit 31 of the [loc32] is 1, else N is cleared.
- C**            If the subtraction generates a borrow, C is cleared; otherwise C is set.
- V**            If an overflow occurs, V is set; otherwise V is not affected.
- OVC**        If OVM = 0 (disabled) and the operation generates a positive overflow, the counter is incremented and if the operation generates a negative overflow, the counter is decremented.  
                   If OVM = 1 (enabled) the counter is not affected by the operation.
- OVM**        If overflow mode bit is set; then the ACC value will saturate maximum positive (0x7FFFFFFF) or maximum negative (0x80000000) if the operation overflowed.

**Repeat**                        This instruction is not repeatable. If this instruction follows the RPT instruction, it resets the repeat counter (RPTC) and executes only once.

**Example**                        ; Decrement the 32-bit value VarA:  
                   MOVB    ACC,#1                                ; Load ACC with 0x00000001  
                   SUBL    @VarA,ACC                            ; VarA = VarA - ACC

**SUBR loc16,AX***Reverse-Subtract Specified Location From AX*

SYNTAX OPTIONS	OPCODE	OBJMODE	RPT	CYC
SUBR loc16,AX	1110 101A LLLL LLLL	1	-	1

**Operands**

**loc16** Addressing mode (see Chapter 5)

**AX** Accumulator high (AH) or accumulator low (AL) register

**Description**

Subtract the 16-bit content of the location pointed to by the "loc16" addressing mode from the specified AX register (AH or AL), and store the result in location pointed to by "loc16":

$$[\text{loc16}] = \text{AX} - [\text{loc16}]$$

This instruction performs a read-modify-write operation.

**Flags and Modes**

**N** After the subtraction, [loc16] is tested for a negative condition. If bit 15 of [loc16] is 1, then the negative flag bit is set; otherwise it is cleared.

**Z** After the subtraction, [loc16] is tested for a zero condition. The zero flag bit is set if the operation generates [loc16] = 0, otherwise it is cleared

**C** If the subtraction generates a borrow, C is cleared; otherwise C is set.

**V** If an overflow occurs, V is set; otherwise V is not affected. Signed positive overflow occurs if the result crosses the max positive value (0x7FFF) in the positive direction. Signed negative overflow occurs if the result crosses the max negative value (0x8000) in the negative direction.

**Repeat**

This instruction is not repeatable. If this instruction follows the RPT instruction, it resets the repeat counter (RPTC) and executes only once.

**Example**

```

; Subtract index register AR0 from VarA and store in AR0:
MOV    AL,@VarA ; Enable          ; Load AL with contents of VarA
sign extensio  ;
with a left shift of 3
SUBR   @AR0,AL   ; AR0 = AL - AR0
; Subtract the contents of VarC from VarB and store in VarC:
MOV    AH,@VarB ; Load AH with contents of VarB
SUBR   @VarC,AH ; VarC = AH - VarC

```

**SUBRL loc32, ACC***Reverse-Subtract Specified Location From ACC*

SYNTAX OPTIONS	OPCODE	OBJMODE	RPT	CYC
SUBRL loc32, ACC	0101 0110 0100 1001 0000 0000 LLLL LLLL	1	-	1

**Operands**    **loc32**    Addressing mode (see Chapter 5)

**ACC**        Accumulator register

**Description**                    Subtract from the ACC register the 32-bit location pointed to by the “loc32” addressing mode and store the result in the location pointed to by “loc32”:

[loc32] = ACC - [loc32];

**Flags and Modes**    **Z**            After the subtraction, the Z flag is set if the ACC value is zero, else Z is cleared.

**N**            After the subtraction, the N flag is set if bit 31 of the ACC is 1, else N is cleared.

**C**            If the subtraction generates a borrow, C is cleared; otherwise C is set.

**V**            If an overflow occurs, V is set; otherwise V is not affected.

**OVC**        If(OVM = 0, disabled) then if the operation generates a positive overflow, then the counter is incremented and if the operation generates a negative overflow, then the counter is decremented. If(OVM = 1, enabled) then the counter is not affected by the operation.

**OVM**        If overflow mode bit is set; then the ACC value will saturate maximum positive (0x7FFFFFFF) or maximum negative (0x80000000) if the operation overflowed.

**Repeat**                            This instruction is not repeatable. If this instruction follows the RPT instruction, it resets the repeat counter (RPTC) and executes only once.

**Example**                    ; Calculate the 32-bit value: VarA = VarB - VarA  
 MOVL    ACC,@VarB                    ; Load ACC with contents of VarB  
 SUBRL   @VarA,ACC                    ; VarA = ACC - VarA



**SUBU ACC, loc16***Subtract Unsigned 16-bit Value*

SYNTAX OPTIONS	OPCODE	OBJMODE	RPT	CYC
SUBU ACC, loc16	0000 0001 LLLL LLLL	X	Y	N+1

**Operands**    **ACC**    Accumulator register  
                  **loc16**    Addressing mode (see Chapter 5)

**Description**            Subtract the 16-bit contents of the location pointed to by the “loc16” addressing mode from the ACC register. The addressed location is zero extended before the add:

$ACC = ACC - 0:[loc16];$

**Flags and Modes**

**Z**            After the subtraction, the Z flag is set if ACC is zero, else Z is cleared.

**N**            After the subtraction, the N flag is set if bit 31 of the ACC is 1, else N is cleared.

**C**            If the subtraction generates a borrow, C is cleared; otherwise C is set.

**V**            If an overflow occurs, V is set; otherwise V is not affected.

**OVC**        If OVM = 0 (disabled) and the operation generates a positive overflow, the counter is incremented and if the operation generates a negative overflow, the counter is decremented.  
                  If OVM = 1 (enabled), the counter is not affected by the operation.

**OVM**        If overflow mode bit is set; then the ACC value will saturate maximum positive (0x7FFFFFFF) or maximum negative (0x80000000) if the operation overflowed.

**Repeat**                If this operation is repeated, then the instruction will be executed N+1 times. The state of the Z, N, C flags will reflect the final result. The V flag will be set if an intermediate overflow occurs. The OVC flag will count intermediate overflows, if overflow mode is disabled.

**Example**                ; Subtract three 32-bit unsigned variables by 16-bit parts:

```

MOVU  ACC,@VarALow           ; AH = 0, AL = VarALow
ADD   ACC,@VarAhigh << 16   ; AH = VarAhigh, AL = VarALow
SUBU  ACC,@VarBlo293w        ; ACC = ACC - 0:VarBlow
SUB   ACC,@VarBhigh << 16   ; ACC = ACC - VarBhigh << 16
SBBU  ACC,@VarClow           ; ACC = ACC - VarClow - ~Carry
SUB   ACC,@VarChigh << 16   ; ACC = ACC - VarChigh << 16

```

**SUBUL ACC, loc32***Subtract Unsigned 32-bit Value*

SYNTAX OPTIONS	OPCODE	OBJMODE	RPT	CYC
SUBUL ACC, loc32	0101 0110 0101 0101 0000 0000 LLLL LLLL	1	-	1

**Operands**    **loc32**    Addressing mode (see Chapter 5)  
                   **ACC**        Accumulator register

**Description**            Subtract from the ACC register the 32-bit the location pointed to by the “loc32” addressing mode. The subtraction is treated as an unsigned SUBL operation:

```
ACC = ACC - [loc32];    // unsigned subtraction
```

**Note:** The difference between a signed and unsigned 32-bit subtract is in the treatment of the overflow counter (OVC). For a signed SUBL, the OVC counter monitors positive/negative overflow. For an unsigned SUBL, the OVC unsigned (OVCU) counter monitors the borrow.

**Flags and Modes**

**Z**            After the subtraction, the Z flag is set if the ACC value is zero, else Z is cleared.

**N**            After the subtraction, the N flag is set if bit 31 of the ACC is 1, else N is cleared.

**C**            If the subtraction generates a borrow, C is cleared; otherwise C is set.

**V**            If an overflow occurs, V is set; otherwise V is not affected.

**OVCU**        The overflow counter is decremented whenever a subtraction operation generates an unsigned borrow. The OVM mode does not affect the OVCU counter.

**Repeat**                This instruction is not repeatable. If this instruction follows the RPT instruction, it resets the repeat counter (RPTC) and executes only once.

**Example**

```
; Subtract two 64-bit values (VarA and VarB) and store result
; in VarC:
MOVL  ACC,@VarA+0            ; Load ACC with contents of the low
                                 ; 32-bits of VarA
SUBUL  ACC,@VarB+0            ; Subtract from ACC the contents of
                                 ; the low 32-bits of VarB
MOVL  @VarC+0,ACC            ; Store low 32-bit result into VarC
MOVL  ACC,@VarA+2            ; Load ACC with contents of the high
                                 ; 32-bits of VarA
SUBBL  ACC,@VarB+2            ; Subtract from ACC the contents of
                                 ; the high 32-bits of VarB with borrow
MOVL  @VarC+2,ACC            ; Store high 32-bit result into VarC
```

**SUBUL P,loc32***Subtract Unsigned 32-bit Value*

SYNTAX OPTIONS	OPCODE	OBJMODE	RPT	CYC
SUBUL P,loc32	0101 0110 0101 1101 0000 0000 LLLL LLLL	1	-	1

**Operands**    **P**        Product register  
                   **loc32**    Addressing mode (see Chapter 5)

**Description**        Subtract from the P register the 32-bit content of the location pointed to by the "loc32" addressing mode. The addition is treated as an unsigned SUB operation:

$P = P - [\text{loc32}]; \quad // \text{ unsigned subtract}$

**Note:** The difference between a signed and unsigned 32-bit subtract is in the treatment of the overflow counter (OVC). For a signed SUBL, the OVC counter monitors positive/negative overflow. For an unsigned SUBL, the OVC unsigned (OVCU) counter monitors the borrow.

**Flags and Modes**

**Z**        After the subtraction, the Z flag is set if the P value is zero, else Z is cleared.

**N**        After the subtraction, the N flag is set if bit 31 of P is 1, else N is cleared.

**C**        If the subtraction generates a borrow, C is cleared; otherwise C is set.

**V**        If a signed overflow occurs, V is set; otherwise V is not affected.

**OVCU**    The overflow counter is decremented whenever a subtraction operation generates an unsigned borrow. The OVM mode does not affect the OVCU counter.

**Repeat**                This instruction is not repeatable. If this instruction follows the RPT instruction, it resets the repeat counter (RPTC) and executes only once.

**Example**

```

; Subtract 64-bit VarA - VarB and store result in VarC:
MOVL  P,@VarA+0           ; Load P with low 32-bits of VarA
MOVL  ACC,@VarA+2        ; Load ACC with high 32-bits of VarA
SUBUL  P,@VarB+0         ; Sub from P unsigned low 32-bits of
                          ; VarB
SUBBL  ACC,@VarB+2       ; Sub from ACC with borrow high 32-bits
                          ; of VarB
MOVL  @VarC+0,P          ; Store low 32-bit result into VarC
MOVL  @VarC+2,ACC        ; Store high 32-bit result into VarC

```

**TBIT loc16,#bit***Test Specified Bit*

SYNTAX OPTIONS	OPCODE	OBJMODE	RPT	CYC
TBIT loc16,#16bit	0100 BBBB LLLL LLLL	X	-	1

**Operands**    **loc16**        **Addressing mode (see Chapter 5)**  
                   **#bit**            **Immediate constant bit index from 0 to 15**

**Description**                    Test the specified bit of the data value in the location pointed to by the “loc16” addressing mode:

```
TC = [loc16(bit)];
```

The value specified for the #bit immediate operand directly corresponds to the bit number. For example, if #bit = 0, you will access bit 0 (least significant bit) of the addressed location; if #bit = 15, you will access bit 15 (most significant bit).

**Flags and Modes**    **TC**            **If the bit tested is 1, TC is set; if the bit tested is 0, TC is cleared.**

**Repeat**                        This instruction is not repeatable. If this instruction follows the RPT instruction, it resets the repeat counter (RPTC) and executes only once.

**Example**

```

; if( VarA.Bit4 = 1 )
;   VarB.Bit6 = 1;
; else
;   VarB.Bit6 = 0;
TBIT  @VarA,#4           ; Test bit 4 of VarA contents
SB    $10,NTC           ; Branch if TC = 0
TSET  @VarB,#6         ; Set bit 6 of VarB contents
SB    $20,UNC          ; Branch unconditionally
$10:
TCLR  @VarB,#6         ; Clear bit 6 of VarB contents
$20:
;
```

**TBIT loc16,T**

*Test Bit Specified by Register*

SYNTAX OPTIONS	OPCODE	OBJMODE	RPT	CYC
TBIT loc16,T	0101 0110 0010 0101 0000 0000 LLLL LLLL	1	-	1

**Operands**    **loc16 T**    **Addressing mode (see Chapter 5)**

**Upper 16 bits of the multiplicand register (XT)**

**Description**                      Test the bit specified by the four least significant bits of the T register, T(3:0) = 0...15 of the data value in the location pointed to by the "loc16" addressing mode. Upper bits of the T register are ignored:

```
bit = 15 - T(3:0);
TC = [loc16(bit)];
```

A value of 15 in the T register corresponds to bit 0 (least significant bit). A value of 0 in the T register corresponds to bit 15 (most significant bit). The upper 12 bits of the T register are ignored.

**Flags and Modes**    **TC**    **If the bit tested is 1, TC is set; if the bit tested is 0, TC is cleared.**

**Repeat**                              This instruction is not repeatable. If this instruction follows the RPT instruction, it resets the repeat counter (RPTC) and executes only once.

```
Example                      ; if( VarA.VarB = 1 )
                             ;     VarC.Bit6 = 1;
                             ; else
                             ;     VarC.Bit6 = 0;
                             MOV     T,@VarB                      ; Load T with bit value in VarB
                             XOR     @T,#15                     ; Reverse order of bit testing
                             TBIT    @VarA,T                    ; Test bit of VarA selected by VarB
                             SB     $10,NTC                    ; Branch if TC = 0
                             TSET   @VarB,#6                   ; Set bit 6 of VarB contents
                             SB     $20,UNC                    ; Branch unconditionally
$10:                           ;
                             TCLR   @VarB,#6                   ; Clear bit 6 of VarB contents
$20:                           ;
```

**TCLR loc16,#bit***Test and Clear Specified Bit*

SYNTAX OPTIONS	OPCODE	OBJMODE	RPT	CYC
TCLR loc16,#bit	0101 0110 0000 1001 0000 BBBB LLLL LLLL	1	-	1

**Operands**    **loc16, #bit**    **Addressing mode (see Chapter 5)**

**Immediate constant bit index from 0 to 15**

**Description**                      Test the specified bit of the data value in the location pointed to by the "loc16" addressing mode and then clear that same bit to 0:

```
TC = [loc16(bit)];
[loc16(bit)] = 0;
```

The value specified for the #bit immediate operand directly corresponds to the bit number. For example, if #bit = 0, you will access bit 0 (least significant bit) of the addressed location; if #bit = 15, you will access bit 15 (most significant bit).

TCLR performs a read-modify-write operation.

**Flags and Modes**

**N**                      **If (loc16 = @AX) and bit 15 (MSB) of @AX is 1, then N flag is set..**

**Z**                      **If (loc16 = @AX) and @AX gets zeroed out, then Z flag is set.**

**TC**                     **If the bit tested is 1, TC is set; if the bit tested is 0, TC is cleared.**

**Repeat**                      This instruction is not repeatable. If this instruction follows the RPT instruction, it resets the repeat counter (RPTC) and executes only once.

**Example**

```
; if( VarA.Bit4 = 1 )
;   VarB.Bit6 = 1;
; else
;   VarB.Bit6 = 0;
   TBIT   @VarA,#4           ; Test bit 4 of VarA contents
   SB     $10,NTC           ; Branch if TC = 0
   TSET   @VarB,#6         ; Set bit 6 of VarB contents
   SB     $20,UNC          ; Branch unconditionally
$10:
   TCLR   @VarB,#6         ; Clear bit 6 of VarB contents
$20:
```

**TEST ACC***Test for Accumulator Equal to Zero*

SYNTAX OPTIONS	OPCODE	OBJMODE	RPT	CYC
TEST ACC	1111 1111 0101 1000	X	-	1

**Operands**    **ACC**    Accumulator register

**Description**                    Compare the ACC register to zero and set the status flag bits accordingly:  
    Modify flags on (ACC - 0x00000000);

**Flags and Modes**    **N**            If bit 31 of the ACC is 1, N is set; else N is cleared.

**Z**            If ACC is zero, Z is set; else Z is cleared.

**Repeat**                            This instruction is not repeatable. If this instruction follows the RPT instruction, it resets the repeat counter (RPTC) and executes only once.

**Example**                    ; Test contents of ACC and branch if zero:  
                                  TEST    ACC                            ; Modify flags on (ACC - 0x00000000)  
                                  SB        Zero,EQ                        ; Branch if zero

TRAP #VectorNumber

Software Trap

SYNTAX OPTIONS	OPCODE	OBJMODE	RPT	CYC
TRAP #VectorNumber	0000 0000 001C CCCC	X	–	8

**Operands**      **Vector**      **CPU interrupt vector 0 to 31**  
                          **Number**

**Description**

The TRAP instruction transfers program control to the interrupt service routine that corresponds to the vector specified in the instruction. It does not affect the interrupt flag register (IFR) or the interrupt enable register (IER), regardless of whether the chosen interrupt has corresponding bits in these registers. The TRAP instruction is not affected by the interrupt global mask bit (INTM) in status register ST1. It also is not affected by the enable bits in the IER or the debug interrupt enable register (DBGIER). Once the TRAP instruction reaches the decode phase of the pipeline, hardware interrupts cannot be serviced until the TRAP instruction is done executing (until the interrupt service routine begins).

The following table indicates which interrupt vector is associated with a chosen value for the VectorNumber operand:

Vector Number	Interrupt Vector	Vector Number	Interrupt Vector
0	RESET	16	RTOSINT
1	INT1	17	Reserved
2	INT2	18	NMI
3	INT3	19	ILLEGAL
4	INT4	20	USER1
5	INT5	21	USER2
6	INT6	22	USER3
7	INT7	23	USER4
8	INT8	24	USER5
9	INT9	25	USER6
10	INT10	26	USER7
11	INT11	27	USER8
12	INT12	28	USER9
13	INT13	29	USER10
14	INT14	30	USER11
15	DLOGINT	31	USER12



Part of the operation involves saving pairs of 16-bit core registers onto the stack pointed to by the SP register. Each pair of registers is saved in a single 32-bit operation. The register forming the low word of the pair is saved first (to an even address); the register forming the high word of the pair is saved next (to the following odd address). For example, the first value saved is the concatenation of the T register and the status register ST0 (T:ST0). ST0 is saved first, then T.

This instruction should not be used with vectors 1–12 when the peripheral interrupt expansion (PIE) is enabled.

**Note:** The TRAP #0 instruction does not initiate a full reset. It only forces execution of the interrupt service routine that corresponds to the RESET interrupt vector.

```
Flush the pipeline;
temp = PC + 1;
Fetch specified vector;
SP = SP + 1;
[SP] = T:ST0;
SP = SP + 2;
[SP] = AH:AL;
SP = SP + 2;
[SP] = PH:PL;
SP = SP + 2;
[SP] = AR1:AR0;
SP = SP + 2;
[SP] = DP:ST1;
SP = SP + 2;
[SP] = DBGSTAT:IER;
SP = SP + 2;
[SP] = temp;
SP = SP + 2;
INTM = 0;           // disable INT1-INT14, DLOGINT, RTOSINT
DBGM = 1;           // disable debug events
EALLOW = 0;        // disable access to emulation registers
LOOP = 0;           // clear loop flag
IDLESTAT = 0;      // clear idle flag
PC = fetched vector;
```

<b>Flags and Modes</b>	<b>DBGM</b>	Debug events are disabled by setting the DBGM bit.
	<b>INTM</b>	Setting the INTM bit disables maskable interrupts.
	<b>EALLOW</b>	EALLOW is cleared to disable access to protected registers.
	<b>LOOP</b>	The loop flag is cleared.
	<b>IDLESTAT</b>	The idle flag is cleared.

**Repeat** This instruction is not repeatable. If this instruction follows the RPT instruction, it resets the repeat counter (RPTC) and executes only once.

**TSET loc16,#16bit***Test and Set Specified Bit*

SYNTAX OPTIONS	OPCODE	OBJMODE	RPT	CYC
TSET loc16,#16bit	0101 0110 0000 1101 0000 BBBB LLLL LLLL	1	-	1

**Operands**    **loc16**    Addressing mode (see Chapter 5)  
                  **#bit**

Immediate constant bit index from 0 to 15

**Description**            Test the specified bit of the data value in the location pointed to by the "loc16" addressing mode and then set the same bit to 1:

```
TC = [loc16(bit)];
[loc16(bit)] = 1;
```

The value specified for the #bit immediate operand directly corresponds to the bit number. For example, if #bit = 0, you will access bit 0 (least significant bit) of the addressed location; if #bit = 15, you will access bit 15 (most significant bit).

TSET performs a read-modify-write operation.

**Flags and Modes**    **N**            If (loc16 == @AX) and bit 15 (MSB) of @AX is 1, then N flag is set..

**Modes**

**Z**            If (loc16 == @AX) and @AX gets zeroed out, then Z flag is set.

**TC**          If the bit tested is 1, TC is set; if the bit tested is 0, TC is cleared.

**Repeat**            This instruction is not repeatable. If this instruction follows the RPT instruction, it resets the repeat counter (RPTC) and executes only once.

**Example**

```
; if( VarA.Bit4 = 1 )
;   VarB.Bit6 = 1;
; else
;   VarB.Bit6 = 0;
   TBIT   @VarA,#4           ; Test bit 4 of VarA contents
   SB     $10,NTC           ; Branch if TC = 0
   TSET   @VarB,#6         ; Set bit 6 of VarB contents
   SB     $20,UNC          ; Branch unconditionally
$10:
   TCLR   @VarB,#6         ; Clear bit 6 of VarB contents
$20:
```

**UOUT \*(PA),loc16**

*Unprotected Output Data to I/O Port*

SYNTAX OPTIONS	OPCODE	OBJMODE	RPT	CYC
UOUT *(PA),loc16	1011 0000 LLLL LLLL CCCC CCCC CCCC CCCC	1	Y	N+2

**Operands**    \*(PA)    Immediate I/O space memory address  
                   loc16

Addressing mode (see Chapter 5)

**Description**                    Store the 16-bit value from the location pointed to by the "loc16" addressing mode into the I/O space location pointed to by \*(PA):

`IOspace[0x000:PA] = loc16;`

I/O Space is limited to 64K range (0x0000 to 0xFFFF). On the external interface (XINTF), if available on a particular device, the I/O strobe signal (XISn) is toggled during the operation. The I/O address appears on the lower 16 address lines (XA(15:0)) and the upper address lines are zeroed. The data appears on the lower 16 data lines (XD(15:0)).

**Note:** The UOUT operation is not pipeline protected. Therefore, if an IN instruction immediately follows a UOUT instruction, the IN will occur before the UOUT. To be certain of the sequence of operation, use the OUT instruction, which is pipeline protected.  
 I/O space may not be implemented on all C28x devices. See the data sheet for your particular device for details.

**Flags and Modes**                    None

**Repeat**                            This instruction is repeatable. If the operation follows a RPT instruction, then it will be executed N+1 times. When repeated, the \*(PA) I/O space address is post-incremented by 1 during each repetition.

**Example**

```
; IOREgA address = 0x0300;
; IOREgB address = 0x0301;
; IOREgC address = 0x0302;
; IOREgA = 0x0000;
; IOREgB = 0x0400;
; IOREgC = VarA;
; if( IOREgC = 0x2000 )
; IOREgC = 0x0000;
IORegA .set 0x0300 ; Define IOREgA address
IORegB .set 0x0301 ; Define IOREgB address
IORegC .set 0x0302 ; Define IOREgC address
MOV @AL,#0 ; AL = 0
UOUT *(IORegA),@AL ; IOspace[IORegA] = AL
MOV @AL,#0x0400 ; AL = 0x0400
UOUT *(IORegB),@AL ; IOspace[IORegB] = AL
OUT *(IORegC),@VarA ; IOspace[IORegC] = VarA
IN @AL,*(IORegC) ; AL = IOspace[IORegC]
CMP @AL,#0x2000 ; Set flags on (AL - 0x2000)
SB $10,NEQ ; Branch if not equal
MOV @AL,#0 ; AL = 0
UOUT *(IORegC),@AL ; IOspace[IORegC] = AL
$10:
```

SYNTAX OPTIONS	OPCODE	OBJMODE	RPT	CYC
XB *AL	0101 0110 0001 0100	1	-	7

**Operands** \*AL Indirect program-memory addressing using register AL, can only access high 64K of program space range (0x3F0000 to 0x3FFFFFF)

**Description** Unconditional indirect branch by loading the low 16 bits of PC with the contents of register AL and forcing the upper 6 bits of the PC to 0x3F:

PC = 0x3F:AL;

**Note:** This branch instruction can only branch to a location located in the upper 64K range of program space (0x3F0000 to 0x3FFFFFF).

**Flags and Modes** None

**Repeat** This instruction is not repeatable. If this instruction follows the RPT instruction, it resets the repeat counter (RPTC) and executes only once.

**Example** ; Branch to subroutines in SwitchTable selected by Switch value.  
; This example only works for code located in upper 64K of  
; program space:

```
SwitchTable:                ; Switch address table:
    .word    Switch0        ; Switch0 address
    .word    Switch1        ; Switch1 address
    .
    .
    MOVL    XAR2,#SwitchTable ; XAR2 = pointer to SwitchTable
    MOVZ    AR0,@Switch      ; AR0 = Switch index
    MOV     AL,*+XAR2[AR0]    ; AL = SwitchTable[Switch]
    XB     *AL                ; Indirect branch using AL
SwitchReturn:
    .

Switch0:                    ; Subroutine 0:
    .
    .
    XB     SwitchReturn,UNC   ; Return: branch

Switch1:                    ; Subroutine 1:
    .
    .
    XB     SwitchReturn,UNC   ; Return: branch
```

**XB pma,\*,ARPN***C2xLP Source-Compatible Branch with ARP Modification*

SYNTAX OPTIONS	OPCODE	OBJMODE	RPT	CYC
XB pma,*,ARPN	0011 1110 0111 0nnn CCCC CCCC CCCC CCCC	1	-	4

**Operands**    **pma**    16-bit immediate program -memory address,  
can only access high 64K of program space range (0x3F0000 to 0x3FFFFFF)

**ARPN**    3-bit auxiliary register pointer (ARP0 to ARP7)

**Description**            Unconditional branch with ARP modification by loading the low 16 bits of PC with the 16-bit immediate value "pma" and forcing the upper 6 bits of the PC to 0x3F. Also, change the auxiliary register pointer as specified by the "ARPN" operand:

PC = 0x3F:pma;  
ARP = n;

**Note:** This branch instruction can only branch to a location located in the upper 64K range of program space (0x3F0000 to 0x3FFFFFF).

**Flags and Modes**            None

**Repeat**                    This instruction is not repeatable. If this instruction follows the RPT instruction, it resets the repeat counter (RPTC) and executes only once.

**Example**                    ; Branch to SubA and set ARP. Load ACC with pointer pointed to  
; by ARP and return to. This example only works for code  
; located in upper 64K of program space:

```
XB        SubA,*,ARP1        ; Branch to SubA with ARP pointing
                                 ; to XAR1
```

SubReturn:

```
SubA:                            ; Subroutine A:
MOVL    ACC,*                 ; Load ACC with contents
                                 ; pointed to by XAR(ARP)
XB        SubReturn,UNC       ; Return unconditionally
```

## XB pma,COND

## C2 xLP Source-Compatible Branch

SYNTAX OPTIONS	OPCODE	OBJMODE	RPT	CYC
XB pma,COND	0101 0110 1101 COND CCCC CCCC CCCC CCCC	1	-	7/4

**Operands**    **pma**    16-bit immediate program-memory address, can only access high 64K of program space range (0x3F0000 to 0x3FFFFFF)

**COND**    Conditional codes:

COND	Syntax	Description	Flags Tested
0000	NEQ	Not Equal To	Z = 0
0001	EQ	Equal To	Z = 1
0010	GT	Greater Than	Z = 0 AND N = 0
0011	GEQ	Greater Than Or Equal To	N = 0
0100	LT	Less Than	N = 1
0101	LEQ	Less Than Or Equal To	Z = 1 OR N = 1
0110	HI	Higher	C = 1 AND Z = 0
0111	HIS, C	Higher Or Same, Carry Set	C = 1
1000	LO, NC	Lower, Carry Clear	C = 0
1001	LOS	Lower Or Same	C = 0 OR Z = 1
1010	NOV	No Overflow	V = 0
1011	OV	Overflow	V = 1
1100	NTC	Test Bit Not Set	TC = 0
1101	TC	Test Bit Set	TC = 1
1110	NBIO	BIO Input Equal To Zero	BIO = 0
1111	UNC	Unconditional	-

**Description**    Conditional branch. If the specified condition is true, then branch by loading the low 16 bits of PC with the 16-bit immediate value "pma" and forcing the upper 6 bits of the PC to 0x3F.; otherwise continue execution without branching:

```
If (COND = true)  PC(15:0) = pma;
If (COND = false) PC(15:0) = PC(15:0) + 2;
PC(21:16) = 0x3F;
```

**Note:** If (COND = true) then the instruction takes 7 cycles.  
If (COND = false) then the instruction takes 4 cycles.

**Flags and Modes**    **V**    If the V flag is tested by the condition, then V is cleared.

**Repeat**    This instruction is not repeatable. If this instruction follows the RPT instruction, it resets the repeat counter (RPTC) and executes only once.

```

Example      ; Branch to subroutines in SwitchTable selected by Switch value.
                ; This example only works for code located in upper 64K of
                ; program space:
SwitchTable:   ; Switch address table:
                .word  Switch0      ; Switch0 address
                .word  Switch1      ; Switch1 address
                .
                .

                MOVL  XAR2,#Switch- ; XAR2 = pointer to SwitchTable
Table          Table
                MOVZ  AR0,@Switch   ; AR0 = Switch index
                MOV   AL,*+XAR2[AR0] ; AL = SwitchTable[Switch]
                XB    *AL           ; Indirect branch using AL
SwitchReturn:
                .

Switch0:       ; Subroutine 0:
                .
                .
                XB    SwitchRe-     ; Return: branch
return,UNC

Switch1:       ; Subroutine 1:
                .
                .
                XB    SwitchRe-     ; Return: branch
return,UNC

```



**XBANZ pma,\*ind{,ARPN}** *C2 x LP Source-Compatible Branch If ARn Is Not Zero*

SYNTAX OPTIONS	OPCODE	OBJMODE	RPT	CYC
XBANZ pma,*	0101 0110 0000 1100 CCCC CCCC CCCC CCCC	1	-	4/2
XBANZ pma,*++	0101 0110 0000 1010 CCCC CCCC CCCC CCCC	1	-	4/2
XBANZ pma,*--	0101 0110 0000 1011 CCCC CCCC CCCC CCCC	1	-	4/2
XBANZ pma,*0++	0101 0110 0000 1110 CCCC CCCC CCCC CCCC	1	-	4/2
XBANZ pma,*0--	0101 0110 0000 1111 CCCC CCCC CCCC CCCC	1	-	4/2
XBANZ pma*,ARPN	0011 1110 0011 0nnn CCCC CCCC CCCC CCCC	1	-	4/2
XBANZ pma,*++,ARPN	0011 1110 0011 1nnn CCCC CCCC CCCC CCCC	1	-	4/2
XBANZ pma,*--,ARPN	0011 1110 0100 0nnn CCCC CCCC CCCC CCCC	1	-	4/2
XBANZ pma,*0++,ARPN	0011 1110 0100 1nnn CCCC CCCC CCCC CCCC	1	-	4/2
XBANZ pma,*0--,ARPN	0011 1110 0101 0nnn CCCC CCCC CCCC CCCC	1	-	4/2

**Operands**    **pma**    16-bit immediate program-memory address, can only access high 64K of program space range (0x3F0000 to 0x3FFFFFF)

**ARPN**    3-bit auxiliary register pointer (ARP0 to ARP7)

**Description**                    If the lower 16 bits of the auxiliary register pointed to by the current auxiliary register pointer (ARP) is not equal to 0, then a branch is taken by loading the lower 16 bits of the PC with the 16-bit immediate “pma” value and forcing the upper 6 bits of the PC to 0x3F. Then, the current auxiliary register, pointed to by the ARP, is modified as specified by the indirect mode. Then,, if indicated, the ARP pointer value is changed to point a new auxiliary register:

```

if ( AR[ARP] != 0 )
    PC = 0x3F:pma
if(*++ indirect mode) XAR[ARP] = XAR[ARP] + 1;
if(*-- indirect mode) XAR[ARP] = XAR[ARP] - 1;
if(*0++ indirect mode) XAR[ARP] = XAR[ARP] + AR0;
if(*0-- indirect mode) XAR[ARP] = XAR[ARP] - AR0;
if(ARPN specified) ARPN = n;

```

**Note:** This instruction can only transfer program control to a location located in the upper 64K range of program space (0x3F0000 to 0x3FFFFFF). The cycle times for this operation are:  
 If branch is taken, then the instruction takes 4 cycles  
 If branch is not taken, then the instruction takes 2 cycles

<b>Flags and Modes</b>	None
<b>Repeat</b>	This instruction is not repeatable. If this instruction follows the RPT instruction, it resets the repeat counter (RPTC) and executes only once.
<b>Example</b>	<pre> ; Copy the contents of Array1 to Array2: ; int32 Array1[N]; ; int32 Array2[N]; ; for(i=0; i &lt; N; i++) ;   Array2[i] = Array1[i]; ; This example only works for code located in upper 64K of ; program space: MOVL   XAR2,#Array1      ; XAR2 = pointer to Array1 MOVL   XAR3,#Array2      ; XAR3 = pointer to Array2 MOV    @AR0,#(N-1)       ; Repeat loop N times NOP    *,ARP2             ; Point to XAR2 SETC   AMODE             ; Full C2XLP address mode compatible Loop: MOVL   ACC,*+,ARP3       ; ACC = Array1[i], point to XAR3 MOVL   *+,ACC,ARP0       ; Array2[i] = ACC, point to XAR0 BANZ   Loop,*--,ARP2     ; Loop if AR[ARP] != 0, AR[ARP]--, ; point to XAR2 </pre>

**XCALL \*AL**

*C2 x LP Source-Compatible Function Call*

SYNTAX OPTIONS	OPCODE	OBJMODE	RPT	CYC
XCALL *AL	0101 0110 0011 0100	1	-	7

**Operands** \*AL Indirect program-memory addressing using register AL, can only access high 64K of program space range (0x3F0000 to 0x3FFFFFF)

**Description** Indirect call with destination address in AL. The lower 16 bits of the current PC address are saved onto the software stack. Then, the low 16 bits of PC is loaded with the contents of register AL and the upper 6 bits of the PC are loaded with 0x3F:

```
temp(21:0) = PC + 1;
[SP] = temp(15:0);
SP = SP + 1;
C = 0x3F:AL;
```

**Note:** This instruction can only transfer program control to a location located in the upper 64K range of program space (0x3F0000 to 0x3FFFFFF). To return from a call made by XCALL, the XRETC instruction must be used.

**Flags and Modes** None

**Repeat** This instruction is not repeatable. If this instruction follows the RPT instruction, it resets the repeat counter (RPTC) and executes only once.

```
Example ; Call function in FuncTable selected by FuncIndex value.
; This example only works for code located in upper 64K of
; program space:
FuncTable: ; Function address table:
    .word   FuncA ; FuncA address
    .word   FuncB ; FuncB address
    .
    .
    MOVL   XAR2,#FuncTable ; XAR2 = pointer to FuncTable
    MOVZ   AR0,@FuncIndex ; AR0 = FuncTable index
    MOV    AL,*+XAR2[AR0] ; AL = Table[FuncIndex]
    XCALL  *AL ; Indirect call using AL
    .
    .
FuncA: ; Function A:
    .
    .
    XRETC  UNC ; Return unconditionally

FuncB: ; Function B:
    .
    .
    XRETC  UNC ; Return unconditionally
```



**XCALL pma,COND**

*C2xLP Source-Compatible Function Call*

SYNTAX OPTIONS	OPCODE	OBJMODE	RPT	CYC
XCALL pma,COND	0101 0110 1110 COND CCCC CCCC CCCC CCCC	1	-	7/4

**Operands**    **pma**    16-bit immediate program-memory address, can only access high 64K of program space range (0x3F0000 to 0x3FFFFFF)

**COND**    Conditional codes:

COND	Syntax	Description	Flags Tested
0000	NEQ	Not Equal To	Z = 0
0001	EQ	Equal To	Z = 1
0010	GT	Greater Than	Z = 0 AND N = 0
0011	GEQ	Greater Than Or Equal To	N = 0
0100	LT	Less Than	N = 1
0101	LEQ	Less Than Or Equal To	Z = 1 OR N = 1
0110	HI	Higher	C = 1 AND Z = 0
0111	HIS, C	Higher Or Same, Carry Set	C = 1
1000	LO, NC	Lower, Carry Clear	C = 0
1001	LOS	Lower Or Same	C = 0 OR Z = 1
1010	NOV	No Overflow	V = 0
1011	OV	Overflow	V = 1
1100	NTC	Test Bit Not Set	TC = 0
1101	TC	Test Bit Set	TC = 1
1110	NBIO	BIO Input Equal To Zero	BIO = 0
1111	UNC	Unconditional	-

**Description**

Conditional call. If the specified condition is true, then the low 16 bits of the return address is pushed onto the software stack and the low 16 bits of the PC are loaded with the 16-bit immediate "pma" value and the upper 6 bits of the PC are forced to 0x3F; otherwise continue execution with instruction following the XCALL operation:

```

if(COND = true)
{
temp(21:0) = PC + 2;
[SP] = temp(15:0);
SP = SP + 1;
PC = 0x3F:pma;
}
else
PC = PC + 2;
    
```

**Note:** This instruction can only transfer program control to a location located in the upper 64K range of program space (0x3F0000 to 0x3FFFFFF). To return from a call made by XCALL, the XRETC instruction must be used. The cycle times for this operation are:

- If (COND = true) then the instruction takes 7 cycles.
- If (COND = false) then the instruction takes 4 cycles.

**Flags and Modes**     V     If the V flag is tested by the condition, then V is cleared.

**Repeat**                     This instruction is not repeatable. If this instruction follows the RPT instruction, it resets the repeat counter (RPTC) and executes only once.

**Example**     ; Call FuncA if VarA does not equal zero. This example only  
; works for code located in upper 64K of program space:  
      MOV    AL,@VarA             ; Load AL with VarA  
      XCALL FuncA,NEQ            ; Call FuncA if not equal to zero  
      .  
      .  
  
FuncA:                             ; Function A:  
      .  
      .  
      XRET    UNC                 ; Return unconditionally

**XMAC P,loc16,\*(pma)**

*C2xLP Source-compatible Multiply and Accumulate*

SYNTAX OPTIONS	OPCODE	OBJMODE	RPT	CYC
XMAC P,loc16,*(pma)	1000 0100 LLLL LLLL CCCC CCCC CCCC CCCC	1	Y	N+2

**Operands**

**P** Product register

**loc16** Addressing mode (see Chapter 5)

**\*(pma)** Immediate program memory address, access high 64K range of program space only (0x3F0000 to 0x3FFFFFF)

**Description**

Add the previous product (stored in the P register), shifted as specified by the product shift mode (PM), to the ACC register. Next, load the T register with the content of the location pointed to by the "loc16" addressing mode. Last, multiply the signed 16-bit content of the T register by the signed 16-bit content of the addressed program memory location and store the 32-bit result in the P register:

```
ACC = ACC + P << PM;
T = [loc16];
P = signed T * signed Prog[0x3F:pma];
```

The C28x forces the upper 6 bits of the program memory address, specified by the "(pma)" addressing mode, to 0x3F when using this form of the MAC instruction. This limits the program memory address to the high 64K of program address space (0x3F0000 to 0x3FFFFFF). On the C28x devices, memory blocks are mapped to both program and data space (unified memory), hence the "(pma)" addressing mode can be used to access data space variables that fall within its address range.

**Flags and Modes**

**Z** After the addition, the Z flag is set if the ACC value is zero, else Z is cleared.

**N** After the addition, the N flag is set if bit 31 of the ACC is 1, else N is cleared.

**C** If the addition generates a carry, C is set; otherwise C is cleared.

**V** If an overflow occurs, V is set; otherwise V is not affected.

**OVC** If overflow mode is disabled; and if the operation generates a positive overflow, then the counter is incremented. If overflow mode is disabled; and if the operation generates a negative overflow, then the counter is decremented.

**OVM** If overflow mode bit is set; then the ACC value will saturate maximum positive (0x7FFFFFFF) or maximum negative (0x80000000) if the operation overflowed.

**PM** The value in the PM bits sets the shift mode for the output operation from the product register. If the product shift value is positive (logical left shift operation), then the low bits are zero filled. If the product shift value is negative (arithmetic right shift operation), the upper bits are sign extended.

**Repeat** This instruction is repeatable. If the operation follows a RPT instruction, then it will be executed N+1 times. The state of the Z, N, C and OVC flags will reflect the final result. The V flag will be set if an intermediate overflow occurs. When repeated, the program-memory address is incremented by 1 during each repetition.

**Example**

```

; Calculate sum of product using 16-bit multiply:
; int16 X[N]      ; Data information
; int16 C[N]      ; Coefficient information, located in high 64K
; sum = 0;
; for(i=0; i < N; i++)
;   sum = sum + (X[i] * C[i]) >> 5;
MOVL  XAR2,#X          ; XAR2 = pointer to X
SPM   -5              ; Set product shift to ">> 5"
ZAPA                      ; Zero ACC, P, OVC
RPT   #N-1            ; Repeat next instruction N times
| |XMAC P,*XAR2++,*(C) ; ACC = ACC + P >> 5,
; P = *XAR2++ * *C++
ADDL  ACC,P << PM     ; Perform final accumulate
MOVL  @sum,ACC        ; Store final result into sum

```



**XMACD P,loc16,\*(pma)** C2xLP Source-Compatible Multiply and Accumulate With Data Move

SYNTAX OPTIONS	OPCODE	OBJMODE	RPT	CYC
XMACD P,loc16,*(pma)	1010 0100 LLLL LLLL CCCC CCCC CCCC CCCC	1	Y	N+2

- Operands**
- P** Product register
  - loc16** Addressing mode (see Chapter 5)
    - Note:** For this operation, register-addressing modes cannot be used. The modes are: @ARn, @AH, @AL, @PH, @PL, @SP, @T. An illegal instruction trap will be generated.
  - \*(pma)** Immediate program memory address, access high 64K range of program space only (0x3F0000 to 0x3FFFFFF)

**Description**

The XMACD instruction functions in the same manner as the XMAC, with the addition of a data move. Add the previous product (stored in the P register), shifted as specified by the product shift mode (PM), to the ACC register. Next, load the T register with the content of the location pointed to by the "loc16" addressing mode. Then, multiply the signed 16-bit content of the T register by the signed 16-bit content of the addressed program memory location and store the 32-bit result in the P register. Last, store the content in the T register onto the next highest memory address pointed to by "loc16" addressing mode:

```
ACC = ACC + P << PM;
T = [loc16];
P = signed T * signed Prog[0x3F:pma];
[loc16 + 1] = T;
```

The C28x forces the upper 6 bits of the program memory address, specified by the "(pma)" addressing mode, to 0x3F when using this form of the MAC instruction. This limits the program memory address to the high 64K of program address space (0x3F0000 to 0x3FFFFFF). On the C28x devices, memory blocks are mapped to both program and data space (unified memory), therefore, the "(pma)" addressing mode can be used to access data-space variables that fall within its address range.

- Flags and Modes**
- Z** After the addition, the Z flag is set if the ACC value is zero, else Z is cleared.
  - N** After the addition, the N flag is set if bit 31 of the ACC is 1, else N is cleared.
  - C** If the addition generates a carry, C is set; otherwise C is cleared.
  - V** If an overflow occurs, V is set; otherwise V is not affected.

- OVC** If overflow mode is disabled and if the operation generates a positive overflow, the counter is incremented. If overflow mode is disabled and if the operation generates a negative overflow, the counter is decremented.
- OVM** If overflow mode bit is set, the ACC value will saturate maximum positive (0x7FFFFFFF) or maximum negative (0x80000000) if the operation overflowed.
- PM** The value in the PM bits sets the shift mode for the output operation from the product register. If the product shift value is positive (logical left shift operation), then the low bits are zero filled. If the product shift value is negative (arithmetic right shift operation), the upper bits are sign extended.

**Repeat** This instruction is repeatable. If the operation follows a RPT instruction, then it will be executed N+1 times. The state of the Z, N, C and OVC flags will reflect the final result. The V flag will be set if an intermediate overflow occurs. When repeated, the program-memory address is incremented by 1 during each repetition.

**Example**

```

; Calculate FIR filter using 16-bit multiply:
; int16 X[N]      ; Data information
; int16 C[N]      ; Coefficient information, located in high 64K
sum = X[N-1] * C[0];
; for(i=1; i < N; i++)
;   {
;     sum = sum + (X[N-1-i] * C[i]) >> 5;
;     X[N-i] = X[N-1-i];
;   }
; X[1] = X[0];
MOVL  XAR2,#X+N      ; XAR2 = point to end of X array
SPM   -5             ; Set product shift to ">> 5"
ZAPA  ; Zero ACC, P, OVC
XMAC  P,*--XAR2,* (C) ; ACC = 0, P = X[N-1] * C[0]
RPT   #N-2          ; Repeat next instruction N-1 times
| |XMACD P,*--XAR2,* (C+1) ; ACC = ACC + P >> 5,
; P = X[N-1-i] * C[i],
; i++
MOV   *+XAR2[2],T   ; X[1] = X[0]
ADDL  ACC,P << PM   ; Perform final accumulate
MOVL  @sum,ACC      ; Store final result into sum

```

**XOR ACC,loc16***Bitwise Exclusive OR*

SYNTAX OPTIONS	OPCODE	OBJMODE	RPT	CYC
XOR ACC,loc16	1011 0111 LLLL LLLL	1	Y	N+1

**Operands**    **ACC**    Accumulator register

**loc16**    Addressing mode (see Chapter 5)

**Description**            Perform a bitwise XOR operation on the ACC register with the zero-extended content of the location pointed to by the “loc16” address mode. The result is stored in the ACC register:

ACC = ACC XOR 0:[loc16];

**Flags and Modes**    **N**            The load to ACC is tested for a negative condition. If bit 31 of ACC is 1, then the negative flag bit is set; otherwise it is cleared.

**Z**            The load to ACC is tested for a zero condition. The zero flag bit is set if the operation generates ACC = 0; otherwise it is cleared

**Repeat**                    This operation is repeatable. If the operation follows a RPT instruction, then the XOR instruction will be executed N+1 times. The state of the Z and N flags will reflect the final result.

**Example**                ; Calculate the 32-bit value: VarA = VarA XOR 0:VarB  
 MOVL    ACC,@VarA                    ; Load ACC with contents of VarA  
 XOR     ACC,@VarB                    ; XOR ACC with contents of 0:VarB  
 MOVL    @VarA,ACC                    ; Store result in VarA

**XOR ACC,#16bit << #0..16***Bitwise Exclusive OR*

SYNTAX OPTIONS	OPCODE	OBJMODE	RPT	CYC
XOR ACC,#16bit << #0..15	0011 1110 0010 SHFT CCCC CCCC CCCC CCCC	1	-	1
XOR ACC,#16bit << #16	0101 0110 0100 1110 CCCC CCCC CCCC CCCC	1	-	1

**Operands**

**ACC** Accumulator register

**#16bit** 16-bit immediate constant value

**#0..16** Shift value (default is "<< #0" if no value specified)

**Description** Perform a bitwise XOR operation on the ACC register with the given 16-bit unsigned constant value left shifted as specified. The value is zero extended and lower order bits are zero filled before the XOR operation. The result is stored in the ACC register:

```
ACC = ACC XOR (0:16bit << shift value);
```

**Flags and Modes**

**N** The load to ACC is tested for a negative condition. If bit 31 of ACC is 1, then the negative flag bit is set; otherwise it is cleared.

**B** The load to ACC is tested for a zero condition. The zero flag bit is set if the operation generates ACC = 0; otherwise it is cleared

**Repeat** This instruction is not repeatable. If this instruction follows the RPT instruction, it resets the repeat counter (RPTC) and executes only once.

**Example**

```
; Calculate the 32-bit value: VarA = VarA XOR 0x08000000
MOVL  ACC,@VarA           ; Load ACC with contents of VarA
XOR   ACC,#0x8000 << 12  ; XOR ACC with 0x08000000
MOVL  @VarA,ACC           ; Store result in VarA
```

**XOR AX,loc16***Bitwise Exclusive OR*

SYNTAX OPTIONS	OPCODE	OBJMODE	RPT	CYC
XOR AX, loc16	0111 000A LLLL LLLL	X	-	1

**Operands**    **AX**     Accumulator high (AH) or accumulator low (AL) register  
                   **loc16**    Addressing mode (see Chapter 5)

**Description**            Perform a bitwise exclusive OR operation on the specified AX register (AH or AL) and the contents of the location pointed to by the "loc16" addressing mode. The result is stored in the specified AX register:

`AX = AX XOR [loc16];`

**Flags and Modes**    **N**            The load to AX is tested for a negative condition. If bit 15 of AX is 1, then the negative flag bit is set; otherwise it is cleared.

**Z**            The load to AX is tested for a zero condition. The zero flag bit is set if the operation generates AX = 0, otherwise it is cleared.

**Repeat**                This instruction is not repeatable. If this instruction follows the RPT instruction, it resets the repeat counter (RPTC) and executes only once.

**Example**              ; XOR the contents of VarA and VarB and store in VarC:  
 MOV    AL,@VarA                    ; Load AL with contents of VarA  
 XOR    AL,@VarB                    ; XOR AL with contents of VarB  
 MOV    @VarC,AL                    ; Store result in VarC

**XOR loc16, AX***Bitwise Exclusive OR*

SYNTAX OPTIONS	OPCODE	OBJMODE	RPT	CYC
XOR loc16, AX	1111 001A LLLL LLLL	X	-	1

**Operands**    **loc16**    Addressing mode (see Chapter 5)

**AX**        Accumulator high (AH) or accumulator low (AL) register

**Description**            Perform a bitwise exclusive OR operation on the 16-bit contents of location pointed to by the “loc16” addressing mode and the specified AX register (AH or AL). The result is stored in the location pointed to by “loc16”:

[loc16] = [loc16] XOR AX;

This instruction performs a read-modify-write operation.

**Flags and Modes**        **N**        The load to [loc16] is tested for a negative condition. If bit 15 of [loc16] is 1, then the negative flag bit is set; otherwise it is cleared.

**Z**        The load to [loc16] is tested for a zero condition. The zero flag bit is set if the operation generates [loc16] = 0, otherwise it is cleared.

**Repeat**                    This instruction is not repeatable. If this instruction follows the RPT instruction, it resets the repeat counter (RPTC) and executes only once.

**Example**                ; XOR the contents of VarA with VarB and store in VarB:  
MOV    AL,@VarA                    ; Load AL with contents of VarA  
XOR    @VarB,AL                    ; VarB = VarB XOR AL

**XOR loc16,#16bit***Bitwise Exclusive OR*

SYNTAX OPTIONS	OPCODE	OBJMODE	RPT	CYC
XOR loc16,#16bit	0001 1100 LLLL LLLL CCCC CCCC CCCC CCCC	X	-	1

**Operands**    **loc16**    Addressing mode (see Chapter 5)  
                   **#16bit**    16-bit immediate constant value

**Description**            Perform a bitwise XOR operation on the content of the location pointed to by the "loc16" addressing mode and the 16-bit immediate constant value. The result is stored in the location pointed to by "loc16":

```
[loc16] = [loc16] XOR 16bit;
```

Smart Encoding:

If loc16 = AH or AL and #16bit is an 8-bit number, then the assembler will encode this instruction as XO"RB AX,#8bt. To override this encoding, use the XORW AX,#16bit instruction alias.

**Flags and Modes**    **N**            After the operation if bit 15 of [loc16] 1, set N; otherwise, clear N.  
                           **Z**            After the operation if [loc16] is zero, set Z; otherwise, clear Z.

**Repeat**                This instruction is not repeatable. If this instruction follows the RPT instruction, it resets the repeat counter (RPTC) and executes only once.

**Example**                ; Toggle Bits 2 and 14 of VarA:  
                           ; VarA = VarA XOR #(1 << 2 | 1 << 14)  
 XOR    @VarA,#(1 << 2 | 1 << 14)            ; Toggle bits 2 and 11 of VarA

**XORB AX, #8bit***Bitwise Exclusive OR 8-bit Value*

SYNTAX OPTIONS	OPCODE	OBJMODE	RPT	CYC
XORB AX, #8bit	1111 000A CCCC CCCC	X	-	1

**Operands**    **AX**        Accumulator high (AH) or accumulator low (AL) register  
                   **#8bit**        8-bit immediate constant value

**Description**                    Perform a bitwise exclusive OR operation on the specified AX register and the 8-bit unsigned immediate constant zero extended. The result is stored in the AX register:

$AX = AX \text{ XOR } 0x00:8bit;$

**Flags and Modes**    **N**            The load to AX is tested for a negative condition. If bit 15 of AX is 1, then the negative flag bit is set; otherwise it is cleared.  
                                   **Z**            The load to AX is tested for a zero condition. The zero flag bit is set if the operation generates  $[loc16] = 0$ , otherwise it is cleared.

**Repeat**                            This instruction is not repeatable. If this instruction follows the RPT instruction, it resets the repeat counter (RPTC) and executes only once.

**Example**                    ; Toggle bit 7 of VarA and store result in VarB:  
                   MOV    AL,@VarA                    ; Load AL with contents of VarA  
                   XORB   AL,#0x80                    ; XOR contents of AL with 0x0080  
                   MOV    @VarB,AL                    ; Store result in VarB



**XPREAD loc16, \*(pma)**

*C2xLP Source-Compatible Program Read*

SYNTAX OPTIONS	OPCODE	OBJMODE	RPT	CYC
XPREAD loc16,*(pma)	1010 1100 MMMM MMMM LLLL LLLL LLLL LLLL	1	Y	N+2

**Operands**    **loc16**    Addressing mode (see Chapter 5)

**\*(pma)**    Immediate program-memory address, can only access high 64K of program space range (0x3F0000 to 0x3FFFFFF)

**Description**                    Load the 16-bit data-memory location pointed to by the “loc16” addressing mode with the 16-bit content of the program-memory location pointed to by “\*(pma)” addressing mode:

```
[loc16] = Prog[0x3F:pma];
```

The C28x forces the upper 6 bits of the program memory address, specified by the “\*(pma)” addressing mode, to 0x3F when using this form of the XPREAD instruction. This limits the program memory address to the high 64K of program address space (0x3F0000 to 0x3FFFFFF). On the C28x devices, memory blocks are mapped to both program and data space (unified memory), hence the “\*(pma)” addressing mode can be used to access data space variables that fall within its address range.

**Flags and Modes**    **N**            If (loc16 = @AX) and bit 15 of AX is 1, then N is set; otherwise N is cleared.

**Z**            If (loc16 = @AX) and the value of AX is zero, then Z is set; otherwise Z is cleared.

**Repeat**                            This instruction is repeatable. If the operation follows a RPT instruction, then it will be executed N+1 times. When repeated, the “\*(pma)” program-memory address is copied to an internal shadow register and the address is post-incremented by 1 during each repetition.

**Example**

```
; Copy the contents of Array1 to Array2:
; int16 Array1[N]; // Located in high 64K of program space
; int16 Array2[N]; // Located in data space
; for(i=0; i < N; i++)
;   Array2[i] = Array1[i];
   MOVL   XAR2,#Array2           ; XAR2 = pointer to Array2
   RPT    #(N-1)                 ; Repeat next instruction N times
| XPREAD *XAR2++,*(Array1)      ; Array2[i] = Array1[i],
                                ; i++
```

**XPREAD loc16, \*AL***C2xLP Source-Compatible Program Read*

SYNTAX OPTIONS	OPCODE	OBJMODE	RPT	CYC
XPREAD loc16,*AL	0101 0110 0011 1100 0000 0000 LLLL LLLL	1	Y	N+4

**Operands**    **loc16**    Addressing mode (see Chapter 5)

**\*AL**        Indirect program-memory addressing using register AL,  
                                 can only access high 64K of program space range (0x3F0000 to 0x3FFFFFF)

**Description**                    Load the 16-bit data-memory location pointed to by the “loc16” addressing mode with the 16-bit content of the program-memory location pointed to by “\*AL” addressing mode:

```
[loc16] = Prog[0x3F:AL];
```

The C28x forces the upper 6 bits of the program memory address, specified by the “\*AL” addressing mode, to 0x3F when using this form of the XPREAD instruction. This limits the program memory address to the high 64K of program address space (0x3F0000 to 0x3FFFFFF). On the C28x devices, memory blocks are mapped to both program and data space (unified memory), hence the “\*AL” addressing mode can be used to access data space variables that fall within its address range.

**Flags and Modes**    **N**        If (loc16 = @AX) and bit 15 of AX is 1, then N is set; otherwise N is cleared.

**Z**        If (loc16 = @AX) and the value of AX is zero, then Z is set; otherwise Z is cleared.

**Repeat**                            This instruction is repeatable. If the operation follows a RPT instruction, then it will be executed N+1 times. When repeated, the “\*AL” program-memory address is copied to an internal shadow register and the address is post-incremented by 1 during each repetition.

**Example**

```
; Copy the contents of Array1 to Array2:
; int16 Array1[N]; // Located in high 64K of program space
; int16 Array2[N]; // Located in data space
; for(i=0; i < N; i++)
;   Array2[i] = Array1[i];
MOV    @AL,#Array1      ; AL = pointer to Array1
MOVL   XAR2,#Array2    ; XAR2 = pointer to Array2
RPT    #(N-1)          ; Repeat next instruction N times
| |XPREAD *XAR2++,*AL  ; Array2[i] = Array1[i],
; i++
```

**XPWRITE \*A,loc16***C2xLP Source-Compatible Program Write*

SYNTAX OPTIONS	OPCODE	OBJMODE	RPT	CYC
XPWRITE *AL,loc16	0101 0110 0011 1101 0000 0000 LLLL LLLL	1	Y	N+4

**Operands**    **\*AL**    Indirect program-memory addressing using register AL, can only access high 64K of program space range (0x3F0000 to 0x3FFFFFF)

**loc16**    Addressing mode (see Chapter 5)

**Description**            Load the 16-bit program-memory location pointed to by **\*\*AL** addressing mode with the 16-bit content of the location pointed to by the **loc16** addressing mode:

```
Prog[0x3F:AL] = [loc16];
```

The C28x forces the upper 6 bits of the program memory address, specified by the **\*\*AL** addressing mode, to 0x3F when using this form of the XPWRITE instruction. This limits the program memory address to the high 64K of program address space (0x3F0000 to 0x3FFFFFF). On the C28x devices, memory blocks are mapped to both program and data space (unified memory), hence the **\*\*AL** addressing mode can be used to access data space variables that fall within its address range.

**Flags and Modes**            None

**Repeat**                    This instruction is repeatable. If the operation follows a RPT instruction, then it will be executed N+1 times. When repeated, the **\*\*AL** program-memory address is copied to an internal shadow register and the address is post-incremented by 1 during each repetition.

**Example**

```
; Copy the contents of Array1 to Array2:
; int16 Array1[N]; // Located in data space
; int16 Array2[N]; // Located in high 64K of program space
; for(i=0; i < N; i++)
;   Array2[i] = Array1[i];
MOVL   XAR2,#Array1      ; XAR2 = pointer to Array1
MOV    @AL,#Array2       ; AL = pointer to Array2
RPT    #(N-1)            ; Repeat next instruction N times
| |XPWRITE *AL,*XAR2++   ; Array2[i] = Array1[i],
                        ; i++
```

**XRET***C2xLP Source-Compatible Return*

SYNTAX OPTIONS	OPCODE	OBJMODE	RPT	CYC
XRET	0101 0110 1111 1111	1	-	7

**Note:** XRET is an alias for RETC unconditional.

**Operands**            None

**Description**            Return conditionally. If the specified condition is true, a 16-bit value is popped from the stack and stored into the low 16 bits of the PC while the upper 6 bits of the PC are forced to 0x3F; Otherwise, execution continues with the instruction following the XRETC operation:

```
if(COND = true)
    SP = SP - 1;
    PC = 0x3F:[SP];
```

**Note:** This instruction can transfer program control only to a location located in the upper 64K range of program space (0x3F0000 to 0x3FFFFFF). To return from a call made by XCALL, the XRET instruction must be used.

**Flags and Modes**    **V**            If the V flag is tested by the condition, then V is cleared.

**Repeat**                    This instruction is not repeatable. If this instruction follows the RPT instruction, it resets the repeat counter (RPTC) and executes only once.

**Example**                    ; Return from FuncA if VarA does not equal zero, else set VarB  
; to zero and return. This example only works for code located  
; in upper 64K of program space:

```
    XCALL  FuncA           ; Call FuncA
    .
FuncA:                               ; Function A:
    .
    .
    .
    MOV   AL,@VarA        ; Load AL with contents of VarA
    XRET  NEQ             ; Return if VarA does not equal 0
    MOV   @VarA,#0        ; Store 0 into VarB
    XRETC  UNC            ; Return unconditionally
```

**XRETC COND***C2xLP Source-Compatible Conditional Return*

SYNTAX OPTIONS	OPCODE	OBJMODE	RPT	CYC
XRETC COND	0101 0110 1111 COND	1	-	4/7

**Operands****COND**

Conditional codes:

COND	Syntax	Description	Flags Tested
0000	NEQ	Not Equal To	Z = 0
0001	EQ	Equal To	Z = 1
0010	GT	Greater Than	Z = 0 AND N = 0
0011	GEQ	Greater Than Or Equal To	N = 0
0100	LT	Less Than	N = 1
0101	LEQ	Less Than Or Equal To	Z = 1 OR N = 1
0110	HI	Higher	C = 1 AND Z = 0
0111	HIS, C	Higher Or Same, Carry Set	C = 1
1000	LO, NC	Lower, Carry Clear	C = 0
1001	LOS	Lower Or Same	C = 0 OR Z = 1
1010	NOV	No Overflow	V = 0
1011	OV	Overflow	V = 1
1100	NTC	Test Bit Not Set	TC = 0
1101	TC	Test Bit Set	TC = 1
1110	NBIO	BIO Input Equal To Zero	BIO = 0
1111	UNC	Unconditional	-

**Description**

Return conditionally. If the specified condition is true, a 16-bit value is popped from the stack and stored into the low 16 bits of the PC while the upper 6 bits of the PC are forced to 0x3F; Otherwise, execution continues with the instruction following the XRETC operation:

```

if(COND = true)
{
    SP = SP - 1;
    PC = 0x3F:[SP];
}
else
    PC = PC + 1;

```

**Note:** This instruction can only transfer program control to a location located in the upper 64K range of program space (0x3F0000 to 0x3FFFFFF). To return from a call made by XCALL, the XRETC instruction must be used. The cycle times for this operation are:

If (COND = true) then the instruction takes 7 cycles.

If (COND = false) then the instruction takes 4 cycles.

**Flags and Modes****V**

If the V flag is tested by the condition, then V is cleared.

**Repeat** This instruction is not repeatable. If this instruction follows the RPT instruction, it resets the repeat counter (RPTC) and executes only once.

**Example** ; Return from FuncA if VarA does not equal zero, else set VarB  
; to zero and return. This example only works for code located  
; in upper 64K of program space:  
XCALL FuncA ; Call FuncA  
. .  
FuncA: ; Function A:  
. .  
. .  
MOV AL,@VarA ; Load AL with contents of VarA  
XRET NEQ ; Return if VarA does not equal 0  
MOV @VarA,#0 ; Store 0 into VarB  
XRET UNC ; Return unconditionally

**ZALR ACC,loc16***Zero AL and Load AH With Rounding*

SYNTAX OPTIONS	OPCODE	OBJMODE	RPT	CYC
ZALR ACC,loc16	0101 0110 0001 0011 0000 0000 LLLL LLLL	1	-	1

**Operands**    **ACC**    Accumulator register  
                   **loc16**    Addressing mode (see Chapter 5)

**Description**            Load low accumulator (AL) with the value 0x8000 and load high accumulator (AH) with the 16-bit contents pointed to by the "loc16" addressing mode.

AH = [loc16];  
 AL = 0x8000;

**Flags and Modes**    **N**            The load to ACC is tested for a negative condition. If bit 31 of ACC is 1, then the negative flag bit is set; otherwise it is cleared.  
                           **Z**            The load to ACC is tested for a zero condition. The zero flag bit is set if the operation generates ACC = 0; otherwise it is cleared

**Repeat**                    This instruction is not repeatable. If this instruction follows the RPT instruction, it resets the repeat counter (RPTC) and executes only once.

**Example**                ; Calculate: Y = round(M\*X << 1 + B << 16)  
                           ; Y, M, X, B are all Q15 numbers  
 SPM    +1                                ; Set product shift mode to << 1  
 MOV    T,@M                            ; T = M                                (Q15)  
 MPY    P,T,@X                          ; P = M \* X                            (Q30)  
 ZALR   ACC,@B                          ; ACC = B << 16 + 0x8000            (Q31)  
 ADDL   ACC,P << PM                    ; Add P to ACC with shift            (Q31)  
 MOV    @Y,AH                            ; Store AH into Y                    (Q15)

**ZAP OVC***Clear Overflow Counter*

SYNTAX OPTIONS	OPCODE	OBJMODE	RPT	CYC
ZAP OVC	0101 0110 0101 1100	1	-	1

**Operands**    **OVC**    overflow counter bits in Status Register 0 (ST0)

**Description**                    Clear the overflow counter (OVC) bits in Status Register 0 (ST0).

**Flags and Modes**    **OVC**    The 6-bit overflow counter bits (OVC) are cleared.

**Repeat**                            This instruction is not repeatable. If this instruction follows the RPT instruction, it resets the repeat counter (RPTC) and executes only once.

**Example**                    ; Calculate: VarD = sat (VarA + VarB + VarC)  
ZAP    OVC                            ; Zero overflow counter  
MOVL   ACC,@VarA                    ; ACC = VarA  
ADDL   ACC,@VarB                    ; ACC = ACC + VarB  
ADDL   ACC,@VarC                    ; ACC = ACC + VarC  
SAT    ACC                            ; Saturate if OVC != 0  
MOVL   @VarD,ACC                    ; Store saturated result into VarD



**ZAPA***Zero Accumulator and P Register*

SYNTAX OPTIONS	OPCODE	OBJMODE	RPT	CYC
ZAPA	0101 0110 0011 0011	1	-	1

**Operands**           None

**Description**           Zero the ACC and P registers as well as the overflow counter (OVC):

```
ACC = 0;
P = 0;
OVC = 0;
```

**Flags and Modes**   **N**    The N bit is set.

**Z**    The Z bit is cleared.

**Repeat**               This instruction is not repeatable. If this instruction follows the RPT instruction, it resets the repeat counter (RPTC) and executes only once.

**Example**

```
; Calculate sum of product using 32-bit multiply and retain
;   high result:
; int32 X[N]; // Data information
; int32 C[N]; // Coefficient information (located in low 4M)
; int32 sum = 0;
; for(i=0; i < N; i++)
;   sum = sum + ((X[i] * C[i]) >> 32) >> 5;
MOVL  XAR2,#X           ; XAR2 = pointer to X
MOVL  XAR7,#C           ; XAR7 = pointer to C
SPM   -5                ; Set product shift to ">> 5"
ZAPA                      ; Zero ACC, P, OVC
RPT   #(N-1)            ; Repeat next instruction N times
| |QMACL P,*XAR2++,*XAR7++ ; ACC = ACC + P >> 5,
; P = (X[i] * C[i]) >> 32
; i++
ADDL  ACC,P << PM       ; Perform final accumulate
MOVL  @sum,ACC          ; Store final result into sum
```

# Emulation Features

---

---

---

---

The CPU in the C28x contains hardware extensions for advanced emulation features that can assist you in the development of your application system (software and hardware). This chapter describes the emulation features that are available on all C28x devices using only the JTAG port (with TI extensions).

For more information about instructions shown in examples in this chapter, see Chapter 6, *Assembly Language Instructions*.

<b>Topic</b>	<b>Page</b>
7.1 Overview of Emulation Features .....	7-2
7.2 Debug Interface .....	7-3
7.3 Debug Terminology .....	7-6
7.4 Execution Control Modes .....	7-7
7.5 Aborting Interrupts With the ABORTI Instruction .....	7-15
7.6 DT-DMA Mechanism .....	7-16
7.7 Analysis Breakpoints, Watchpoints, and Counter(s) .....	7-19
7.8 Data Logging .....	7-23
7.9 Sharing Analysis Resources .....	7-30
7.10 Diagnostics and Recovery .....	7-31

## 7.1 Overview of Emulation Features

The CPU's hardware extensions for advanced emulation features provide simple, inexpensive, and speed-independent access to the CPU for sophisticated debugging and economical system development, without requiring the costly cabling and access to processor pins required by traditional emulator systems. It provides this access without intruding on system resources.

The on-chip development interface provides:

- Minimally intrusive access to internal and external memory
- Minimally intrusive access to CPU and peripheral registers
- Control of the execution of background code while continuing to service time-critical interrupts
  - Break on a software breakpoint instruction (instruction replacement)
  - Break on a specified program or data access without requiring instruction replacement (accomplished using bus comparators)
  - Break on external attention request from debug host or additional hardware
  - Break after the execution of a single instruction (single-stepping)
  - Control over the execution of code from device power up
- Nonintrusive determination of device status
  - Detection of a system reset, emulation/test-logic reset, or power-down occurrence
  - Detection of the absence of a system clock or memory-ready signal
  - Determination of whether global interrupts are enabled
  - Determination of why debug accesses might be blocked
- Rapid transfer of memory contents between the device and a host (data logging)
- A cycle counter for performance benchmarking. With a 100-MHz cycle clock, the counter can benchmark actions up to 3 hours in duration.

## 7.2 Debug Interface

The target-level TI debug interface uses the five standard IEEE 1149.1 (JTAG) signals ( $\overline{\text{TRST}}$ , TCK, TMS, TDI, and TDO) and the two TI extensions (EMU0 and EMU1). Figure 7–1 shows the 14-pin JTAG header that is used to interface the target to a scan controller, and Table 7–1 (page 7-4) defines the pins.

As shown in the figure, the header requires more than the five JTAG signals and the TI extensions. It also requires a test clock return signal (TCK\_RET), the target supply ( $V_{\text{CC}}$ ) and ground (GND). TCK\_RET is a test clock out of the scan controller and into the target system. The target system uses TCK\_RET if it does not supply its own test clock (in which case TCK would simply not be used). In many target systems, TCK\_RET is simply connected to TCK and used as the test clock.

Figure 7–1. JTAG Header to Interface a Target to the Scan Controller

TMS	1	2	$\overline{\text{TRST}}$
TDI	3	4	GND
PD ( $V_{\text{CC}}$ )	5	6	No pin (key)
TDO	7	8	GND
TCK_RET	9	10	GND
TCK	11	12	GND
EMU0	13	14	EMU1

**Header dimensions:**  
 Pin-to-pin spacing: 0.100 in. (X,Y)  
 Pin width: 0.025-in. square post  
 Pin length: 0.235-in. nominal

Table 7–1. 14-Pin Header Signal Descriptions

Signal	Description	Emulator State <sup>†</sup>	Target State <sup>†</sup>
EMU0	Emulation pin 0	I	I/O
EMU1	Emulation pin 1	I	I/O
GND	Ground		
PD (V <sub>CC</sub> )	Presence detect. Indicates that the emulation cable is connected and that the target is powered up. PD should be tied to V <sub>CC</sub> in the target system.	I	O
TCK	Test clock. TCK is a clock source from the emulation cable pod. This signal can be used to drive the system test clock.	O	I
TCK_RET	Test clock return. Test clock input to the emulator. Can be a buffered or unbuffered version of TCK.	I	O
TDI	Test data input	O	I
TDO	Test data output	I	O
TMS	Test mode select	O	I
$\overline{\text{TRST}}^{\ddagger}$	Test reset	O	I

<sup>†</sup> I = input; O = output

<sup>‡</sup> Do not use pullup resistors on  $\overline{\text{TRST}}$ : it has an internal pulldown device. In a low-noise environment,  $\overline{\text{TRST}}$  can be left floating. In a high-noise environment, an additional pulldown resistor may be needed. (The size of this resistor should be based on electrical current considerations.)

The state of the  $\overline{\text{TRST}}$ , EMU0, and EMU1 signals at device power up determine the operating mode of the device. The operating mode takes effect as soon as the device has sufficient power to operate. Should the  $\overline{\text{TRST}}$  signal rise, the EMU0 and EMU1 signals are sampled on its rising edge and the operating mode is latched. Some of these modes are reserved for test purposes, but those that can be of use in a target system are detailed in Table 7–2. A target system is not required to support any mode other than normal mode.

Table 7–2. Selecting Device Operating Modes By Using  $\overline{\text{TRST}}$ , EMU0, and EMU1

$\overline{\text{TRST}}$	EMU1	EMU0	Device Operating Mode	JTAG Cable Active?
Low	Low	Low	<i>Slave mode.</i> Disables the CPU and memory portions of the C28x. Another processor treats the C28x as a peripheral.	No
Low	Low	High	Reserved for testing	No
Low	High	Low	<i>Wait-in-reset mode.</i> Prolongs the device's reset until released by external means. This allows a C28x to power up in reset, provided external hardware holds EMU0 low only while power-up reset is active.	Yes
Low	High	High	<i>Normal mode with emulation disabled.</i> This is the setting that should be used on target systems when a scan controller (such as the XDS510) is not attached. $\overline{\text{TRST}}$ will be pulled down and EMU1 and EMU0 pulled up within the C28x; this is the default mode.	No
High	Low or High	Low or High	<i>Normal mode with emulation enabled.</i> This is the setting to use on target systems when a scan controller is attached (the scan controller will control $\overline{\text{TRST}}$ ). $\overline{\text{TRST}}$ should not be high during device power-up.	Yes

### 7.3 Debug Terminology

The following definitions will help you to understand the information in the rest of this chapter:

- Background code.** The body of code that can be halted during debugging because it is not time-critical.
- Foreground code.** The code of time-critical interrupt service routines, which are executed even when background code is halted.
- Debug-halt state.** The state in which the device does not execute background code.
- Time-critical interrupt.** An interrupt that must be serviced even when background code is halted. For example, a time-critical interrupt might service a motor controller or a high-speed timer.
- Debug event.** An action, such as the decoding of a software breakpoint instruction, the occurrence of an analysis breakpoint/watchpoint, or a request from a host processor that can result in special debug behavior, such as halting the device or pulsing one of the signals EMU0 or EMU1.
- Break event.** A debug event that causes the device to enter the debug-halt state.

## 7.4 Execution Control Modes

The C28x supports two debug execution control modes:

- Stop mode
- Real-time mode

Stop mode provides complete control of program execution, allowing for the disabling of all interrupts. Real-time mode allows time-critical interrupt service routines to be performed while execution of other code is halted. Both execution modes can suspend program execution at break events, such as occurrences of software breakpoint instructions or specified program-space or data-space accesses.

### 7.4.1 Stop Mode

Stop mode causes break events, such as software breakpoints and analysis watchpoints, to suspend program execution at the next interrupt boundary (which is usually identical to the next instruction boundary). When execution is suspended, all interrupts (including  $\overline{\text{NMI}}$  and  $\overline{\text{RS}}$ ) are ignored until the CPU receives a directive to run code again. In stop mode, the CPU can operate in the following execution states:

- Debug-halt state.** This state is entered through a break event, such as the decoding of a software breakpoint instruction or the occurrence of an analysis breakpoint/watchpoint. This state can also be entered by a request from the host processor. In the stop mode debug-halt state, the CPU is halted. You can place the device into one of the other two states by giving the appropriate command to the debugger.

The CPU cannot service any interrupts, including  $\overline{\text{NMI}}$  and  $\overline{\text{RS}}$  (reset). When multiple instances of the same interrupt occurs without the first instance being serviced, the later instances are lost.

- Single-instruction state.** This state is entered when you tell the debugger to execute a single instruction by using a RUN 1 command or a STEP 1 command. The CPU executes the single instruction pointed to by the PC and then returns to the debug-halt state (it executes from one interrupt boundary to the next). The CPU is only in the single-instruction state until that single instruction is done.

If an interrupt occurs in this state, the command used to enter this state determines whether that interrupt can be serviced. If a RUN 1 command was used, the CPU can service the interrupt. If a STEP 1 command was used, the CPU cannot, even if the interrupt is  $\overline{\text{NMI}}$  or  $\overline{\text{RS}}$ .

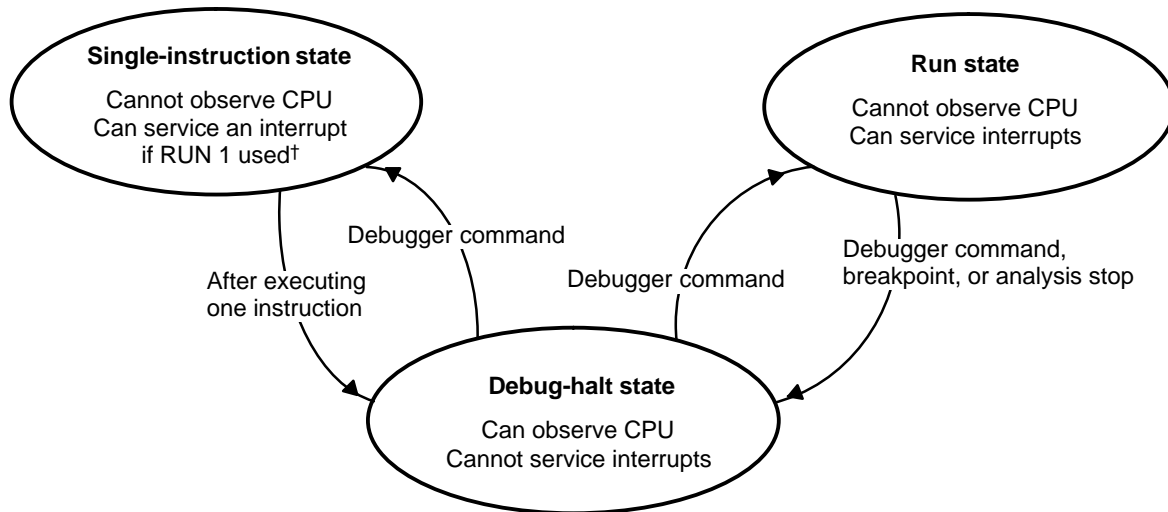
- Run state.** This state is entered when you use a run command from the debugger interface. The CPU executes instructions until a debugger command or a debug event returns the CPU to the debug-halt state.



The CPU can service all interrupts in this state. When an interrupt occurs simultaneously with a debug event, the debug event has priority; however, if interrupt processing began before the debug event occurred, the debug event cannot be processed until the interrupt service routine begins.

Figure 7–2 illustrates the relationship among the three states. Notice that the C28x cannot pass directly between the single-instruction and run states. Notice also that the CPU can be observed only in the debug-halt state. In practical terms, this means the contents of CPU registers and memory are not updated in the debugger display in the single-instruction state or the run state. Maskable interrupts occurring in any state are latched in the interrupt flag register (IFR).

Figure 7–2. Stop Mode Execution States



<sup>†</sup> If you use a RUN 1 command to execute a single instruction, an interrupt can be serviced in the single-instruction state. If you use a STEP 1 command for the same purpose, an interrupt cannot be serviced.

## 7.4.2 Real-Time Mode

Real-time mode provides for the debugging of code that interacts with interrupts that must not be disabled. Real-time mode allows you to suspend background code at break events while continuing to execute time-critical interrupt service routines (also referred to as foreground code). In real-time mode, the CPU can operate in the following execution states:

- Debug-halt state.** This state is entered through a break event such as the decoding of a software breakpoint instruction or the occurrence of an analysis breakpoint/watchpoint. This state can also be entered by a request from the host processor. You can place the device into one of the other two states by giving the appropriate command to the debugger.

In this state, only time-critical interrupts can be serviced. No other code can be executed. Maskable interrupts are considered time-critical if they are enabled in the debug interrupt enable register (DBGIER). If they are also enabled in the interrupt enable register (IER), they are serviced. The interrupt global mask bit (INTM) is ignored.  $\overline{\text{NMI}}$  and  $\overline{\text{RS}}$  are also considered time-critical, and are always serviced once requested. It is possible for multiple interrupts to occur and be serviced while the device is in the debug-halt state.

Suspending execution adds only one cycle to interrupt latency. When the C28x returns from a time-critical ISR, it reenters the debug-halt state.

If a CPU reset occurs (initiated by  $\overline{\text{RS}}$ ), the device runs the corresponding interrupt service routine until that routine clears the debug enable mask bit (DBGM) in status register ST1. When a reset occurs, DBGM is set, disabling debug events. To reenables debug events, the interrupt service routine must clear DBGM. Only then will the outstanding emulation-suspend condition be recognized.

---

**Note:**

Should a time-critical interrupt occur in real-time mode at the precise moment that the debugger receives a RUN command, the time-critical interrupt will be taken and serviced in its entirety before the CPU changes states.

---

- Single-instruction state.** This state is entered when you tell the debugger to execute a single instruction by using a RUN 1 command or a STEP 1 command. The CPU executes the single instruction pointed to by the PC and then returns to the debug-halt state (it executes from one interrupt boundary to the next).

If an interrupt occurs in this state, the command used to enter this state determines whether that interrupt can be serviced. If a RUN 1 command was

used, the CPU can service the interrupt. If a STEP 1 command was used, the CPU cannot, even if the interrupt is  $\overline{\text{NMI}}$  or  $\overline{\text{RS}}$ . In real-time mode, if the DBGM bit is 1 (debug events are disabled), a RUN 1 or STEP 1 command forces continuous execution of instructions until DBGM is cleared.

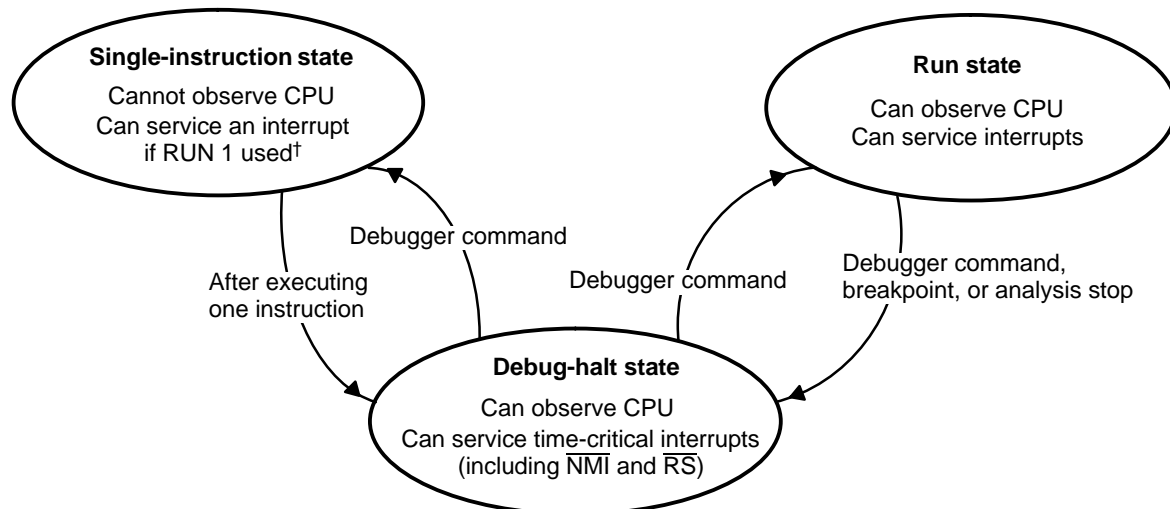
**Note:** If you single-step an instruction in real-time emulation mode and that instruction sets DBGM, the CPU continues to execute instructions until DBGM is cleared. If you want to single-step through a non-time-critical interrupt service routine (ISR), you must initiate a CLRC DBGM instruction at the beginning of the ISR. Once you clear DBGM, you can single-step or place breakpoints.

□ **Run state.** This state is entered when you use a run command from the debugger interface. The CPU executes instructions until a debugger command or a debug event returns the CPU to the debug-halt state.

The CPU can service all interrupts in this state. When an interrupt occurs simultaneously with a debug event, the debug event has priority; however, if interrupt processing began before the debug event occurred, the debug event cannot be processed until the interrupt service routine begins.

Figure 7–3 illustrates the relationship among the three states. Notice that the C28x cannot pass directly between the single-instruction and run states. Notice also that the CPU can be observed in the debug-halt state and in the run state. In the single-instruction state, the contents of CPU registers and memory are not updated in the debugger display. In the debug-halt and run states, register and memory values are updated unless  $\text{DBGM} = 1$ . Maskable interrupts occurring in any state are latched in the interrupt flag register (IFR).

Figure 7–3. Real-time Mode Execution States



† If you use a RUN 1 command to execute a single instruction, an interrupt can be serviced in the single-instruction state. If you use a STEP 1 command for the same purpose, an interrupt cannot be serviced.

***Caution about breakpoints within time-critical interrupt service routines***

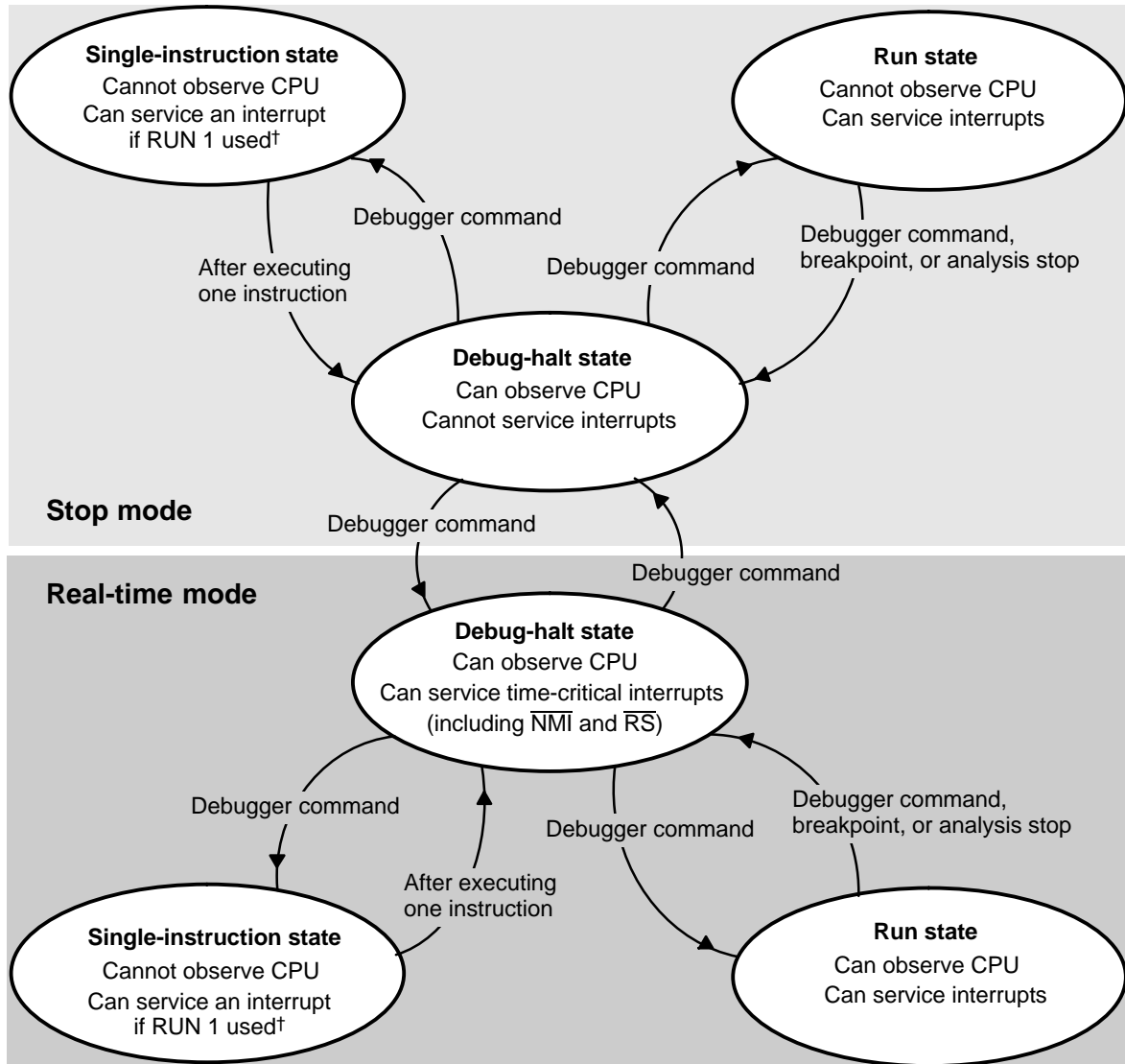
Do not use breakpoints within time-critical interrupt service routines. They will cause the device to enter the debug-halt state, just as if the breakpoint were located in normal code. Once in the debug-halt state, the CPU services requests for  $\overline{RS}$ ,  $\overline{NMI}$ , and those interrupts enabled in the DBGIER and the IER.

After approving a maskable interrupt, the CPU disables the interrupt in the IER. This prevents subsequent occurrences of the interrupt from being serviced until the IER is restored by a return from interrupt (IRET) instruction or until the interrupt is deliberately re-enabled in the interrupt service routine (ISR). Do not reenable that interrupt's IER bit while using breakpoints within the ISR. If you do so and the interrupt is triggered again, the CPU performs a new context save and restarts the interrupt service routine.

**7.4.3 Summary of Stop Mode and Real-Time Mode**

Figure 7-4 (page 7-12) is a graphical summary of the differences between the execution states of stop mode and real-time mode. Table 7-3 (page 7-13) is a summary of how interrupts are handled in each of the states of stop mode and real-time mode.

Figure 7-4. Stop Mode Versus Real-Time Mode



<sup>†</sup> If you use a RUN 1 debugger command to execute a single instruction, an interrupt can be serviced in the single-instruction state. If you use a STEP 1 debugger command for the same purpose, an interrupt cannot be serviced.

Table 7–3. Interrupt Handling Information By Mode and State

Mode	State	If This Interrupt Occurs ...	The Interrupt Is ...
Stop	Debug-halt	$\overline{RS}$	Not serviced
		$\overline{NMI}$	Not serviced
		Maskable interrupt	Latched in IFR but not serviced
	Single-instruction	$\overline{RS}$	If running: Serviced If stepping: Not serviced
		$\overline{NMI}$	If running: Serviced If stepping: Not serviced
		Maskable interrupt	If running: Serviced If stepping: Latched in IFR but not serviced
Run	$\overline{RS}$	Serviced	
	$\overline{NMI}$	Serviced	
	Maskable interrupt	Serviced	
Real-time	Debug-halt	$\overline{RS}$	Serviced
		$\overline{NMI}$	Serviced
		Maskable interrupt	If time-critical: Serviced. If not time-critical: Latched in IFR but not serviced
	Single-instruction	$\overline{RS}$	If running: Serviced If stepping: Not serviced
		$\overline{NMI}$	If running: Serviced If stepping: Not serviced
		Maskable interrupt	If running: Serviced If stepping: Latched in IFR but not serviced
Run	$\overline{RS}$	Serviced	
	$\overline{NMI}$	Serviced	
	Maskable interrupt	Serviced	

**Note:**

Unless you are using a real-time operating system, do not enable the real-time operating system interrupt (RTOSINT). RTOSINT is completely disabled when bit 15 in the IER is 0 and bit 15 in the DBGIER is 0.

## 7.5 Aborting Interrupts With the ABORTI Instruction

Generally, a program uses the IRET instruction to return from an interrupt. The IRET instruction restores all the values that were saved to the stack during the automatic context save. In restoring status register ST1 and the debug status register (DBGSTAT), IRET restores the debug context that was present before the interrupt.

In some target applications, you might have interrupts that must not be returned from by the IRET instruction. Not using IRET can cause a problem for the emulation logic, because the emulation logic assumes the original debug context will be restored. The abort interrupt (ABORTI) instruction is provided as a means to indicate that the debug context will not be restored and the debug logic needs to be reset to its default state. As part of its operation, the ABORTI instruction:

- Sets the DBGGM bit in ST1. This disables debug events.
- Modifies select bits in DBGSTAT. The effect is a resetting of the debug context. If the CPU was in the debug-halt state before the interrupt occurred, the CPU does not halt when the interrupt is aborted. The CPU automatically switches to the run state. If you want to abort an interrupt, but keep the CPU halted, insert a breakpoint after the ABORTI instruction.

The ABORTI instruction does not modify the DBGIER, the IER, the INTM bit, or any analysis registers (for example, registers used for breakpoints, watchpoints, and data logging).



## 7.6 DT-DMA Mechanism

The debug-and-test direct memory access (DT-DMA) mechanism provides access to memory, CPU registers, and memory-mapped registers (such as emulation registers and peripheral registers) without direct CPU intervention. DT-DMAs intrude on CPU time; however, you can block them by setting the debug enable mask bit (DBGM) in ST1.

Because the DT-DMA mechanism uses the same memory-access mechanism as the CPU, any read or write access that the CPU can perform in a single operation can be done by a DT-DMA. The DT-DMA mechanism presents an address (and data, in the case of a write) to the CPU, which performs the operation during an unused bus cycle (referred to as a *hole*). Once the CPU has obtained the desired data, it is presented back to the DT-DMA mechanism. The DT-DMA mechanism can operate in the following modes:

- Nonpreemptive mode.** The DT-DMA mechanism waits for a hole on the desired memory buses. During the hole, the DT-DMA mechanism uses them to perform its read or write operation. These holes occur naturally while the CPU is waiting for newly fetched instructions, such as during a branch.
- Preemptive mode.** In preemptive mode, the DT-DMA mechanism forces the creation of a hole and performs the access.

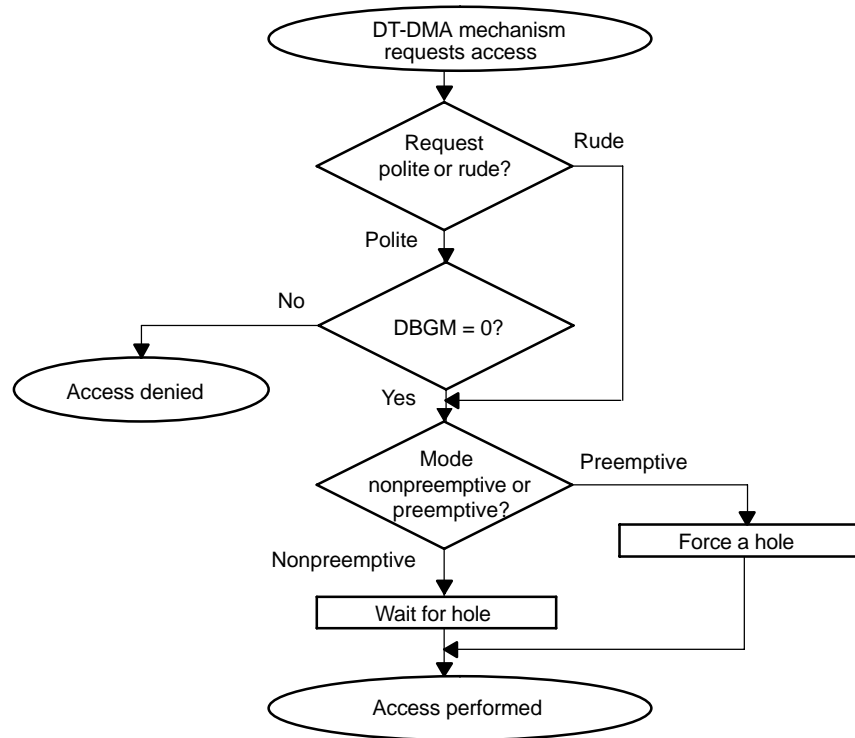
Nonpreemptive accesses to zero-wait-state memory take no cycles away from the CPU. If wait-stated memory is accessed, the pipeline stalls during each wait state, just as a normal memory access would cause a stall. In real-time mode, DT-DMAs to program memory cannot occur when application code is being run from memory with more than one wait state.

DT-DMAs can be polite or rude.

- Polite accesses.** Polite DT-DMAs require that DBGM = 0.
- Rude accesses.** Rude DT-DMAs ignore DBGM.

Figure 7–5 summarizes the process for handling a request from the DT-DMA mechanism.

Figure 7-5. Process for Handling a DT-DMA Request



Some key concepts of the DT-DMA mechanism are:

- Even if `DBGM = 0`, when the mechanism is in nonpreemptive mode, it must wait for a hole. This minimizes the intrusiveness of the debug access on a system.
- Real-time-mode accesses are typically polite (although there may be reasons, such as error recovery, to perform rude accesses in real-time mode). If the `DBGM` bit is permanently set to 1 due to a coding bug but you need to regain debug control, use rude accesses, which ignore the state of `DBGM`.
- In stop mode, `DBGM` is ignored, and the DT-DMA mode is set to preemptive. This ensures that you can gain visibility to and control of your system if an otherwise unrecoverable error occurs (for example, if `ST1` is changed to an undesired value due to stack corruption).

- ❑ The DT-DMA mechanism does not cause a program-flow discontinuity. No interrupt-like save/restore is performed. When a preemptive DT-DMA forces a hole, no program address counters increment during that cycle.
- ❑ A DT-DMA request awakens the device from the idle state (initiated by the IDLE instruction). However, unlike returning from an interrupt, the CPU returns to the idle state upon completion of the DT-DMA.

**Note:**

The information shown on the debugger screen is gathered at different times from the target; therefore, it does not represent a snapshot of the target state, but rather a composite. It also takes the host time to process and display the data. The data does not correspond to the current target state, but rather, the target state as of a few milliseconds ago.

## 7.7 Analysis Breakpoints, Watchpoints, and Counter(s)

All C28x devices include two analysis units AU1 and AU2. Analysis Unit 1 (AU1) counts events or monitors address buses. Analysis Unit 2 (AU2) monitors address and data buses. You can configure these two analysis units as analysis breakpoints or watchpoints. In addition, AU1 can be configured as a benchmark counter or event counter.

This section describes three types of analysis features: analysis breakpoints, watchpoints, and counters. Typical analysis unit configurations are presented in section 7.7.4. Data logging is described in section 7.8.

### 7.7.1 Analysis Breakpoints

An analysis breakpoint is sometimes called a hardware breakpoint, because it acts like a software breakpoint instruction (in this case, the ESTOP0 instruction) but does not require a modification to the application software. An analysis breakpoint triggers a debug event when an instruction at a breakpoint address would have entered the decode 2 phase of the pipeline; this halts the CPU before the instruction is executed. A bus comparator watches the program address bus, comparing its contents against a reference address and a bit mask value.

Consider the following example. If a hardware breakpoint is set at T0, the CPU stops after returning from the T1 subroutine, with the instruction counter (IC) pointing to T0.

```

      NOP
      CALL  T1
T0: MOVB  AL, #0x00
      SB   TIMINGS, UNC
T1: NOP
      RET
T2: NOP

```

Hardware breakpoints allow masking of address bits. For example, a hardware breakpoint could be placed on the address range 00 0200<sub>16</sub>–00 02FF<sub>16</sub> by specifying the following mask address, where the eight LSBs are don't cares:

```
00 0000 0000 0010 XXXX XXXX2
```

### 7.7.2 Watchpoints

A hardware watchpoint triggers a debug event when either an address or an address and data match a compare value. The address portion is compared against a reference address and bit mask, and the data portion is compared against a reference data value and a bit mask.

When comparing two addresses, you can set two watchpoints. When comparing an address and a data value, you can set only one watchpoint. When performing a read watchpoint, the address is available a few cycles earlier than the data; the watchpoint logic accounts for this.

The point where execution stops depends on whether the watchpoint was a read or write watchpoint, and whether it was an address or an address/data read watchpoint. In the following example, a read address watchpoint occurs when the address X is accessed, and the CPU stops with the instruction counter (IC) pointing three instructions after that point:

```
MOV    AR4, #X
MOV    AL, *+AR4[0] ; Data read
nop
nop
nop                ; The IC will point here
```

For a read watchpoint that requires both an address and data match, the CPU stops with the IC pointing six instructions after that point:

```
MOV    AR4, #X
MOV    AL, *+AR4[0] ; Data read
nop
nop
nop
nop
nop                ; The IC will point here
```

In the following example, a write address watchpoint occurs when the address Y is accessed, and the CPU stops with the IC pointing six instructions after that point:

```
MOV    AR4, #Y
MOV    *+AR4[0], AL ; Data write
nop
nop
nop
nop
nop                ; The IC will point here
```

### 7.7.3 Benchmark Counter/Event Counter(s)

The 40-bit performance counter on the C28x can be used as a benchmark counter to increment every CPU clock cycle (it can be configured not to count when the CPU is in the debug-halt state). Wait states affect the counter. Wait states in the read 1 and write pipeline phases of an executing instruction affect the counter, regardless of whether an instruction is being single-stepped or run. However, wait states in the fetch 1 pipeline phase do not affect the counter during single-stepping, because the cycle counting does not begin until the de-

code 2 pipeline phase. The counter counts wait states caused by instructions that are fetched but not executed. In most cases, these effects cancel each other out. Benchmarking is best used for larger portions of code. Do not rely heavily on the precision of the benchmarking. (For more information about the pipeline, see Chapter 4.)

Alternatively, you can configure the 40-bit performance counter as two 16-bit or one 32-bit event counter if you want to generate a debug event when the counter equals a match value. The comparison between the counter value and the match value is done before the count value is incremented. For example, suppose you initialize a counter to 0. A match value of 0 causes an immediate debug event (when the action to be counted occurs), and the counter holds 1 afterward.

You can also clear the counter when a hardware breakpoint or address watchpoint occurs. With this feature, you can implement a mechanism similar to a watchdog timer: if a certain address is not seen on the address bus within a certain number of CPU clock cycles, a debug event occurs.

#### 7.7.4 Typical Analysis Unit Configurations

Each analysis unit can be configured to perform one analysis job at a time. Typical configurations for these two analysis units can be any one of the following:

- Two analysis breakpoints (i.e., hardware breakpoints)  
Detect when an instruction is executed from a specified address or range of addresses. Each hardware breakpoint only requires one analysis unit.
- Two hardware address watch points  
Detect when any value is either read from or written to a specified address or a range of addresses. In this case, the data written or read is not specified. Only the address of the location is specified and whether to watch for reads or writes to that address. Each watchpoint only requires one analysis unit.
- One address with data watchpoint  
Detect when a specified data value is either read from or written to a specified address. In this configuration you can either watch for a read or a write but not both reads and writes. This type of watchpoint requires both analysis units.
- A set of two chained breakpoints  
Detect when a given instruction is executed after another specified instruction.

- A benchmark counter/event counter

The benchmark counter is only available with analysis unit 1. This counter can be used as a benchmark counter to count cycles or instructions. It can also be used to count AU2 events.

Configuration of the analysis resources is supported in Code Composer Studio. For more information on configuring these, use the Code Composer online help.

## 7.8 Data Logging

Data logging enables the C28x to send selected memory values to a host processor using the standard JTAG port and an XDS510 or other compatible scan controller. You control data logging activity with your application code.

To perform data logging, you must create a linear buffer of 32-bit words to hold a packet of information. Your application code controls the size, format, and location of this buffer and also determines when to send a buffer's contents to the host. You can control the size of a data logging buffer in two ways:

- Specify a count value in the upper eight bits of ADDRH (when the number of 32-bit words you want to log is between 1 and 256)
- Specify an end address

---

**Note:**

When the debugger is not active, the data logging transfers are considered complete as soon as they are enabled to prevent the application software from getting stuck when there is nothing to receive the data.

---

### 7.8.1 Creating a Data Logging Transfer Buffer

To create a data logging transfer buffer, follow these steps in your application code:

- 1) Execute the EALLOW instruction to enable access to emulation registers.
- 2) Specify the start address of the buffer in ADDR1 and the six LSBs of ADDR2 (see Figure 7-6 and Figure 7-7). The address in ADDR1 and ADDR2 is called the transfer address.
- 3) Use either of the following methods to specify when data logging is to end:
  - a) If the number of words you want to log is between 1 and 256, specify a count value in the upper eight bits of ADDR2 (see Figure 7-7). The form of the count value is  $256-n$ , where  $n$  is the number of 32-bit words you want to log. As each word is transferred, both the transfer address and the count value are decremented.
  - b) If the number of words you want to log is greater than 256, specify a data logging end address in REFL and the six LSBs of REFH (see Figure 7-8 and Figure 7-9). Load the ten MSBs of REFH with 0s. When using this method, be sure to set the data logging end address control register (EVT\_CNTRL) first, and then the DMA control register



(DMA\_CNTRL). EVT\_CNTRL is described in Table 7-5 (page 7-26), and DMA\_CNTRL is described in Table 7-4 (page 7-25).

**Note:**

The application must *not* read from the end address of the buffer during the data logging operation. When the end address appears on the address bus, the C28x ends the transfer.

- 4) Execute the EDIS instruction to disable access to emulation registers.

See Table 7-4 and Table 7-5 on the following pages for descriptions of the registers associated with data logging.

Figure 7-6. ADDR\_L (at Data-Space Address 00 0838<sub>16</sub>)

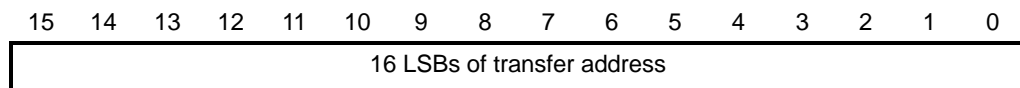


Figure 7-7. ADDR\_H (at Data-Space Address 00 0839<sub>16</sub>)

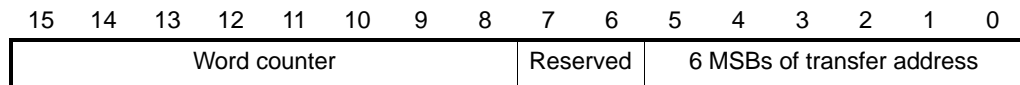


Figure 7-8. REFL (at Data-Space Address 00 084A<sub>16</sub>)

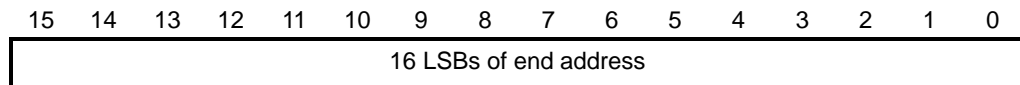


Figure 7-9. REFH (at Data-Space Address 00 084B<sub>16</sub>)

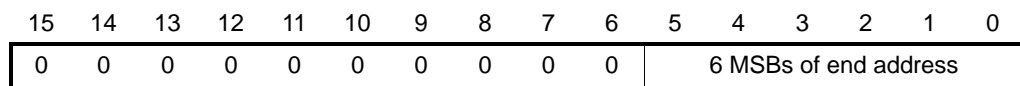


Table 7–4. Start Address and DMA Registers

Address	Name	Access	Description
00 0838 <sub>16</sub>	ADDRL	R/W	<b>Start address register (lower 16 bits)</b> 15:0 Lower 16 bits of start address
00 0839 <sub>16</sub>	ADDRH	R/W	<b>Word counter/start address register (upper 6 bits)</b> 15:8 Word counter. When using this to stop the data logging transfer, set the counter to $256 - n$ , where $n$ is the number of 32-bit words to transfer. Otherwise set the counter to 0. 7:6 Reserved. Set to 0. 5:0 Upper 6 bits of start address
00 083E <sub>16</sub>	DMA_CNTRL	R/W	<b>DMA control register</b> 15:14 Set to 0 13 Set to 1 12 Set to 1 11 Give higher priority to: 0: CPU (nonpreemptive mode) 1: Data logging (preemptive mode) 10 Allow data logging during time-critical ISR? 0: No 1: Yes 9 Allow data logging while DBGCM = 1? 0: No (polite accesses) 1: Yes (rude accesses) 8:6 Set to 1 5:4 0: EMU0/EMU1 using TCK 1: EMU0/EMU1 using FCK/2 2: JTAG signals 3: Reserved 3:2 Method for ending data logging session: 0: Use the count register to stop data logging 1: Use an end address to stop data logging 1:0 Data logging control/status: 0: Release resource from data logging operation 1: Claim resource for data logging operation 2: Enable resource for data logging operation 3: Data logging operation is complete. Bits 14:10 are corrupted when this occurs.
00 083F <sub>16</sub>	DMA_ID	R	<b>DMA ID register</b> 15:14 Resource control: 0: Resource is free 1: Application owns resource 2: Debugger owns resource 13:12 Set to 3. 11:0 Set to 1.

Table 7–5. End-Address Registers

Address	Name	Access	Description
00 0848 <sub>16</sub>	MASKL	R/W	Set to 0
00 0849 <sub>16</sub>	MASKH	R/W	Set to 0
00 084A <sub>16</sub>	REFL	R/W	<b>Data logging end reference address (lower 16 bits)</b> 15:0 Lower 16 bits of start address
00 084B <sub>16</sub>	REFH	R/W	<b>Data logging end reference address (upper 6 bits)</b> 15:6 Set to 0 5:0 Upper 6 bits of start address
00 084E <sub>16</sub>	EVT_CNTRL	R/W	<b>Data logging end address control register</b> 15:14 Set to 0 13 Set to 1 12 Set to 1 11:5 Set to 0 4:2 Set to 1 1:0 End-address resource control/status: 0: Release end-address resource. 1: Claim end-address resource. 2: Enable end-address resource. 3: Data logging operation has ended. Bits 14:10 are corrupted when this occurs.
00 084F <sub>16</sub>	EVT_ID	R	<b>Data logging end address ID register</b> 15:14 Resource control: 0: Resource is free 1: Application owns resource 2: Debugger owns resource 13:12 Set to 1 11:0 Set to 2

### 7.8.2 Accessing the Emulation Registers Properly

Make sure your application code follows the following protocol when accessing the emulation registers that have been provided for data logging. Each resource has a control register and an ID register.

- 1) Enable writes to memory-mapped registers by using the EALLOW instruction.
- 2) Write to the appropriate control register to claim the resource you want to use. The resource for data logging transfers uses DMA\_CNTRL (see Table 7–4 on page 7-25). The resource for detecting the data logging end address uses EVT\_CNTRL (see Table 7–5).

- 3) Wait at least three cycles so that the write to the control register (done in the write phase of the pipeline) occurs before the read from the ID register in step 4. You can fill in the extra cycles with NOP (no operation) instructions or with other instructions that do not involve accessing the emulation registers.
- 4) Read the appropriate ID register and verify that the application is the owner. The resource for data logging transfers uses DMA\_ID (see Table 7-4 on page 7-25). The resource for detecting the data logging end address uses EVT\_ID (see Table 7-5 on page 7-26). If the application is not the owner, then go back to step 2 until this succeeds (you may want a time-out function to prevent an endless loop). This step is optional. The application would fail to become the owner only if the debugger already owns the resource.
- 5) If the application is the owner, the remaining registers for that function can be programmed, and the control register written to again, to enable the function. However, if the application is not the owner, then all of its writes are ignored.
- 6) Disable writes to memory-mapped emulation registers by executing the EDIS instruction.

If an interrupt occurs between the EALLOW instruction in step 1 and the EDIS instruction in step 6, access to emulation registers are automatically disabled by the CPU before the interrupt service routine begins and automatically reenabled when the CPU returns from the interrupt. This means that there is no need to disable interrupts between the EALLOW instruction and the EDIS instruction.

The debugger can, at your request, seize ownership of a register from the application; however, that is not the normal mode of operation.

### 7.8.3 Data Log Interrupt (DLOGINT)

The completion of a data logging transfer (determined either by the word counter or by the end address) triggers a DLOGINT request. DLOGINT is serviced only if it is properly enabled. If the CPU is halted in real-time mode, DLOGINT must be enabled in both the DBGIER and the IER. Otherwise, DLOGINT must be enabled in the IER and by the INTM bit in status register ST1.

This interrupt capability is most useful when there are multiple buffers of data to be transferred through data logging and the completion of one transfer should begin the next.

### 7.8.4 Examples of Data Logging

Example 7–1 shows how to log 20 32-bit words, starting at address 00 0100<sub>16</sub> in data memory. The accesses are preemptive (they have higher priority than the CPU) and rude (they ignore the state of the DBGGM bit). In addition, data logging can occur during time-critical interrupt service routines. The application can determine whether the data logging operation is complete by polling the LSB of the DMA control register (DMA\_CNTRL) at 00 083E<sub>16</sub>. When the operation is complete, that bit is set to 1.

#### Example 7–1. Initialization Code for Data Logging With Word Counter

```

; Base addresses
ADMA      .set  0838h

; Offsets
DMA_ADDR_L .set  0
DMA_ADDR_H .set  1
DMA_CNTRL  .set  6
DMA_ID     .set  7

EALLOW
MOV  AR4, #ADMA          ; AR4 pointing to register base addr
MOV  *+AR4[#DMA_CNTRL],#1 ; Attempt to claim resource
NOP
NOP
NOP
CMP  *+AR4[#DMA_ID],#7001h ; Value expected in ID register
B    FAIL, NEQ           ; If we don't see the correct ID, then we
                          ; failed (the resource is already in use)

MOV  *+AR4[#DMA_ADDR_L],#0100h ; Set starting address of buffer,
                               ; and then the count
MOV  *+AR4[DMA_ADDR_H],#((256 - 20) << 8)

MOV  *+AR4[DMA_CNTRL],#3E62h
EDIS

```

Example 7–2 shows how to log from address 00 0100<sub>16</sub> to address 00 02FF<sub>16</sub> in data memory. The accesses are nonpreemptive (they have lower priority than the CPU), and are polite (they are not performed when the DBGGM bit is 0). The data logging cannot occur when a time-critical interrupt is being serviced. An end address of 00 02FF<sub>16</sub> is used to end the transfer. The application must not read from 00 02FF<sub>16</sub> during the data logging; a read from that address stops the data logging. As in Example 7–1, the application can poll the LSB of DMA\_CNTRL for a 1 to determine whether the data logging operation is complete.

*Example 7-2. Initialization Code for Data Logging With End Address*

```

; Base addresses
ADMA      .set  0838h
DEVT      .set  0848h

; Offsets
DMA_ADDRL .set  0
DMA_ADDRH .set  1
DMA_CNTRL .set  6
DMA_ID    .set  7
MASKL     .set  0
MASKH     .set  1
REFL      .set  2
REFH      .set  3
EVT_CNTRL .set  6
EVT_ID    .set  7

EALLOW
MOV  AR5, #DEVT           ; AR5 pointing to End Address registers
MOV  AR4, #ADMA           ; AR4 pointing to Start/Control base
MOV  *+AR5[#EVT_CNTRL],#1 ; Attempt to claim End Address
MOV  *+AR4[#DMA_CNTRL],#1 ; Attempt to claim Start/Control
NOP
NOP
NOP
CMP  *+AR5[#EVT_ID],#5002h ; Value expected in ID register
B    FAIL, NEQ            ; If we don't see the correct ID, FAIL

CMP  *+AR4[#DMA_ID],#7001h ; Value expected in ID register
B    FAIL, NEQ            ; If we don't see the correct ID, FAIL

MOV  *+AR5[#MASKL],#0     ; Attempt to claim End Address
MOV  *+AR5[#MASKH],#0     ; Attempt to claim End Address
MOV  *+AR5[#REFL],#02FFh  ; Stop data logging at address 0x02FF
MOV  *+AR5[#REFH],#0      ; Attempt to claim End Addr
MOV  *+AR5[#EVT_CNTRL],# ( 2 | (1<<2) | (1<<12) | (1<<13) )

MOV  *+AR4[#DMA_ADDRL],#0100h ; Set buffer start address and then the count
MOV  *+AR4[#DMA_ADDRH],#0

MOV  *+AR4[#DMA_CNTRL],#3066h
EDIS

```

## 7.9 Sharing Analysis Resources

You can use analysis breakpoints, watchpoints, and a benchmark/event counter through the debugger, and you can use data logging through application code. Table 7–6 lists the analysis resources, and Figure 7–10 shows which resources are available to be used at the same time.

When the application owns analysis resources, they will be cleared (made un-owned and set to the completed state) by a reset. When the debugger owns the resources, they are not cleared by reset but by the JTAG test-logic reset. This ensures that when you are using the debugger, the resources can be used even while the target system undergoes a reset.

Table 7–6. Analysis Resources

Resource	Purpose
BA0	Break on contents of program address or memory address bus
BA1	Break on contents of program address or memory address bus
BD	Break on contents of program data, memory read data, or memory write data in addition to an address bus
Data log	Perform data logging using counter
Benchmark	Count CPU cycles

Figure 7–10. Valid Combinations of Analysis Resources

	BA0	BA1	BD	Data log	Benchmark
BA0	Yes	Yes	No	Yes <sup>†</sup>	Yes
BA1	Yes	Yes	No	No	No
BD	No	No	Yes	No	No
Data log	Yes <sup>†</sup>	No	No	Yes	No
Benchmark	Yes	No	No	No	Yes

<sup>†</sup> The data logging mode that uses the word counter allows this combination, but not the data logging mode that uses the end address (see section 7.8, *Data Logging*).

## 7.10 Diagnostics and Recovery

Debug registers within the CPU keep track of the state of several key signals. This allows diagnosis of such problems as a floating READY signal,  $\overline{\text{NMI}}$  signal, or  $\overline{\text{RS}}$  (reset) signal. Should the debug software attempt an operation that does not complete after a certain time-out period (as determined by the debug software), it attempts to determine the probable cause and display the situation to you. You can then abort, correct the situation or allow it to correct itself, or chose to override it.

Such situations include:

- $\overline{\text{RS}}$  being asserted
- A ready signal not being asserted for a memory access
- $\overline{\text{NMI}}$  being asserted
- The absence of a functional clock
- The occurrence of a JTAG test-logic-reset



*This page intentionally left blank*

---

This page intentionally left blank

# Register Quick Reference

---

---

---

For the status and control registers of the '28x, this appendix summarizes:

- Their reset values
- The instructions available for accessing them
- The functions of their bits

<b>Topic</b>	<b>Page</b>
<b>A.1 Reset Values of and Instructions for Accessing the Registers . . . .</b>	<b>A-2</b>
<b>A.2 Register Figures .....</b>	<b>A-3</b>

## A.1 Reset Values of and Instructions for Accessing the Registers

Table A–1 lists the CPU status and control registers, their reset values, and the instructions that are available for accessing the registers.

*Table A–1. Reset Values of the Status and Control Registers*

Register	Description	Reset Value	Instructions
ST0	Status register 0	0000 0000 0000 0000 <sub>2</sub>	PUSH, POP, SETC, CLRC
ST1	Status register 1	0000 M000 0000 V011 <sub>2</sub>	PUSH, POP, SETC, CLRC
IFR	Interrupt flag register	0000 0000 0000 0000 <sub>2</sub>	PUSH, POP, AND, OR
IER	Interrupt enable register	0000 0000 0000 0000 <sub>2</sub>	MOV, AND, OR
DBGIER	Debug interrupt enable register	0000 0000 0000 0000 <sub>2</sub>	PUSH, POP

**Note:** V: Bit 3 of ST1 (the VMAP bit) depends on the level of the VMAP input signal at reset. If the VMAP signal is low, the VMAP bit is 0 after reset; if the VMAP signal is high, the VMAP bit is 1 after reset. For C28x devices that do not pin out VMAP, the signal is tied high internal to the device.

M: Bit 11 of ST1 (the M0M1MAP bit) depends on the level of the M0M1MAP input signal at reset. If the M0M1MAP signal is low, the bit is 0, high bit is 1. For C28x devices that do not pinout M0M1MAP, the signal is tied high internal to the device.

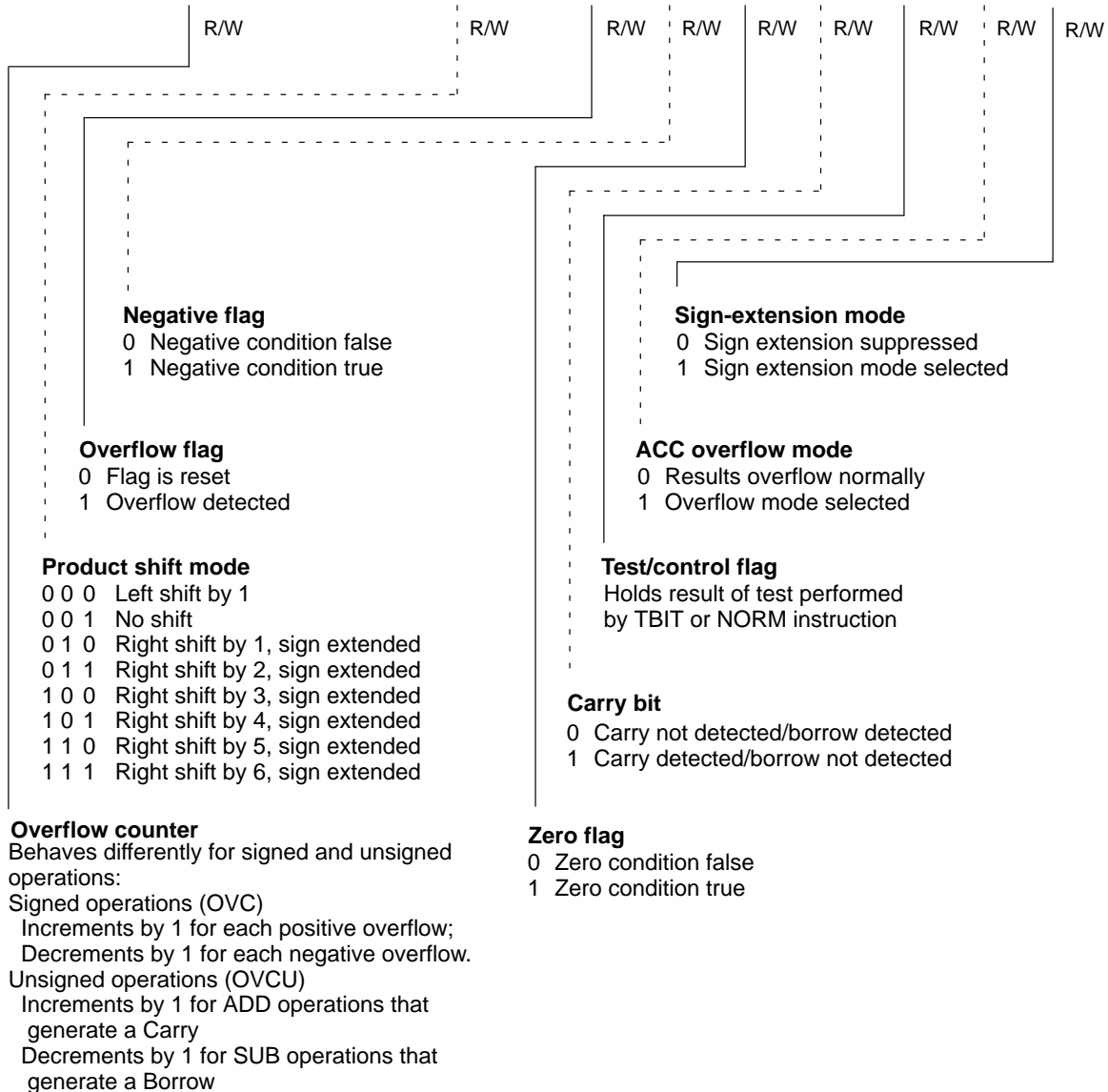
## A.2 Register Figures

The following figures summarize the content of the '28x status and control registers. Each figure in this section provides information in this way:

- The value shown in the register is the value after reset.
- Each unreserved bit field or set of bits has a callout that very briefly describes its effect on the processor.
- Each nonreserved bit field or set of bits is labeled with one of the following symbols:
  - R indicates that your software can read the bit field but cannot write to it.
  - R/W indicates that your software can read the bit field and write to it.
- Where needed, footnotes provide additional information for a particular figure.

Figure A-1. Status register ST0

15	14	13	12	11	10	9	8	7	6	5	4	3	2	1	0
0	0	0	0	0	0	0	0	0	0	0	0	0	0	0	0
OVC/OVCU						PM		V	N	Z	C	TC	OVM	SXM	



**Note:** For more details about ST0, see section 2.3 on page 2-16.

Figure A-2. Status register ST1, Bits 15-8

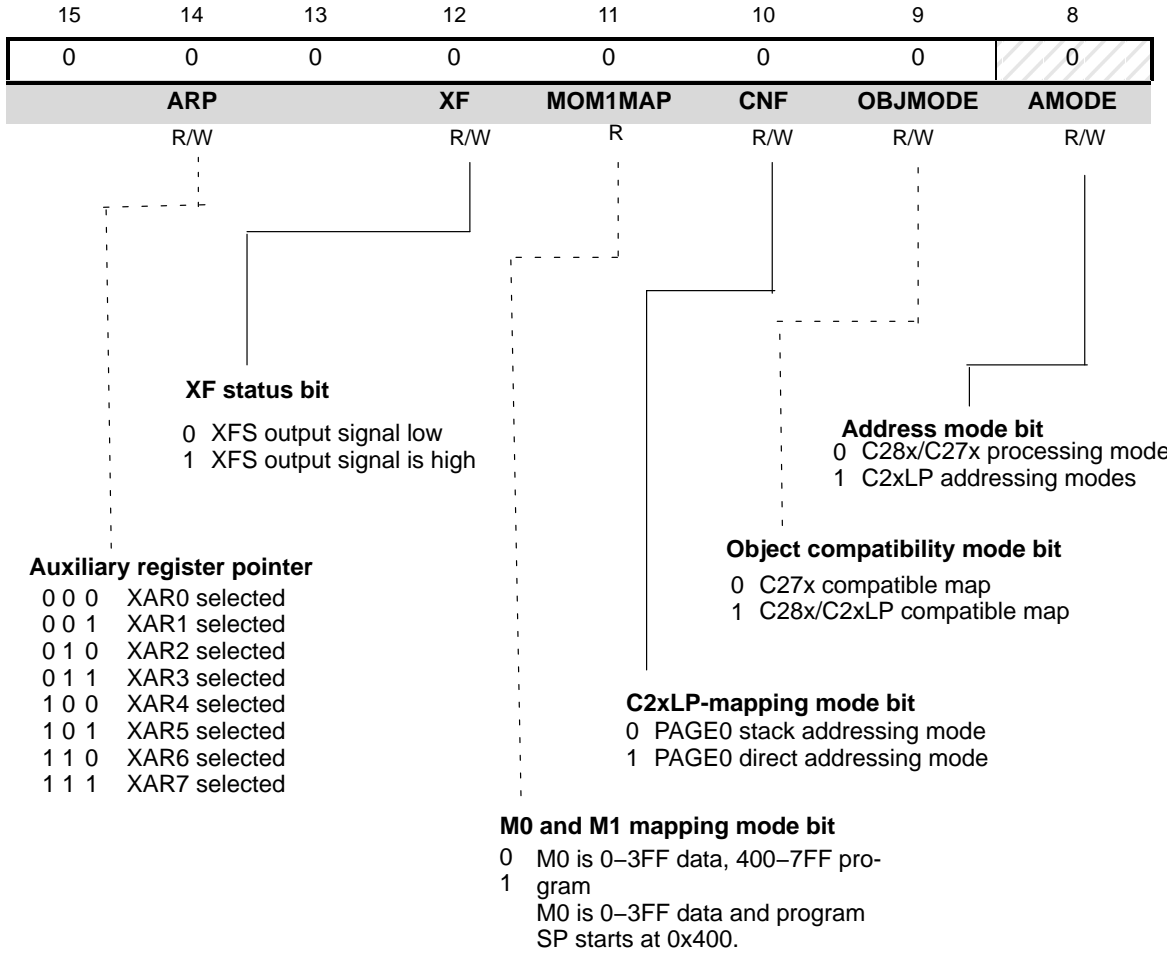
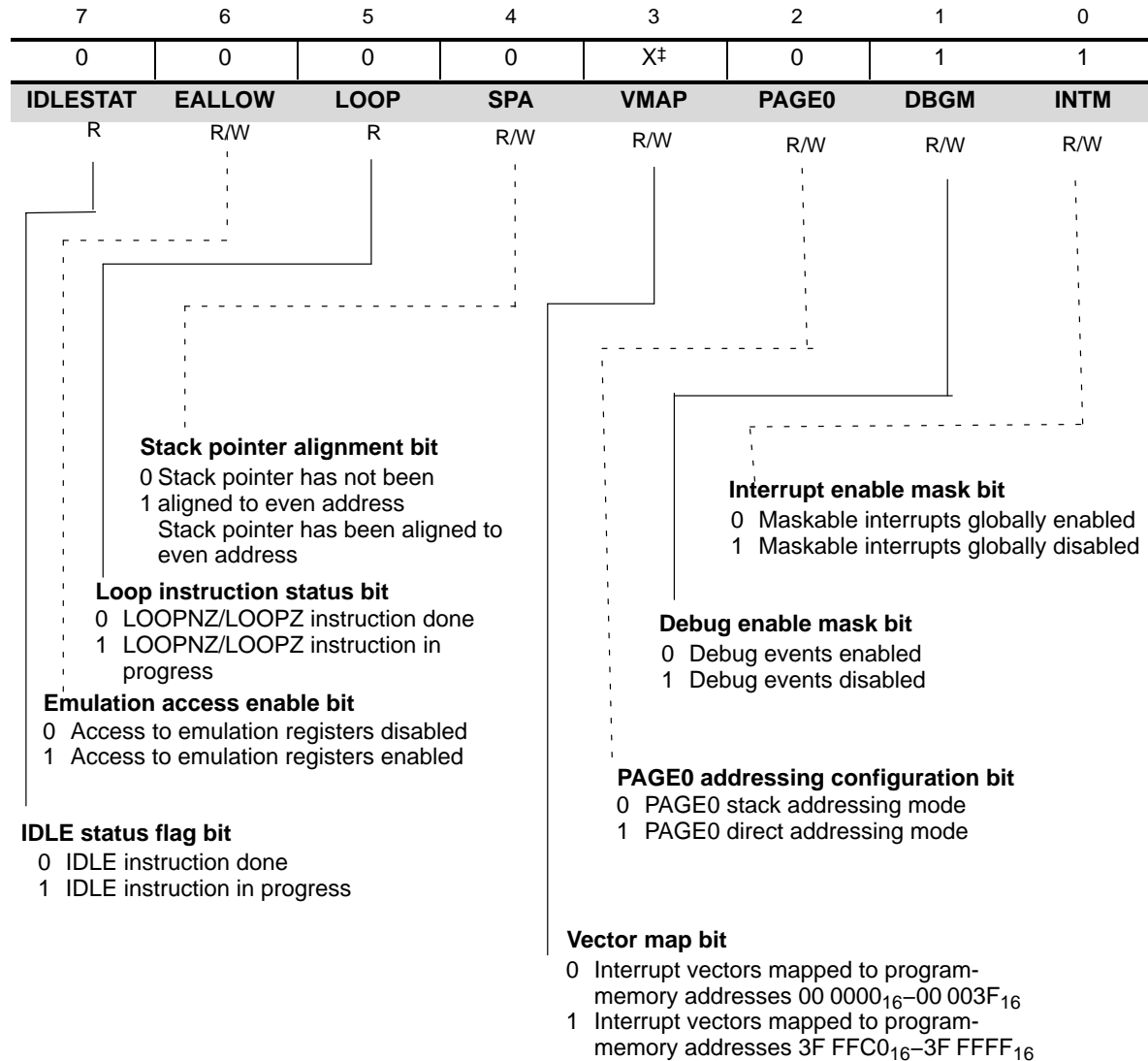


Figure A-3. Status Register ST1, Bits 7-0

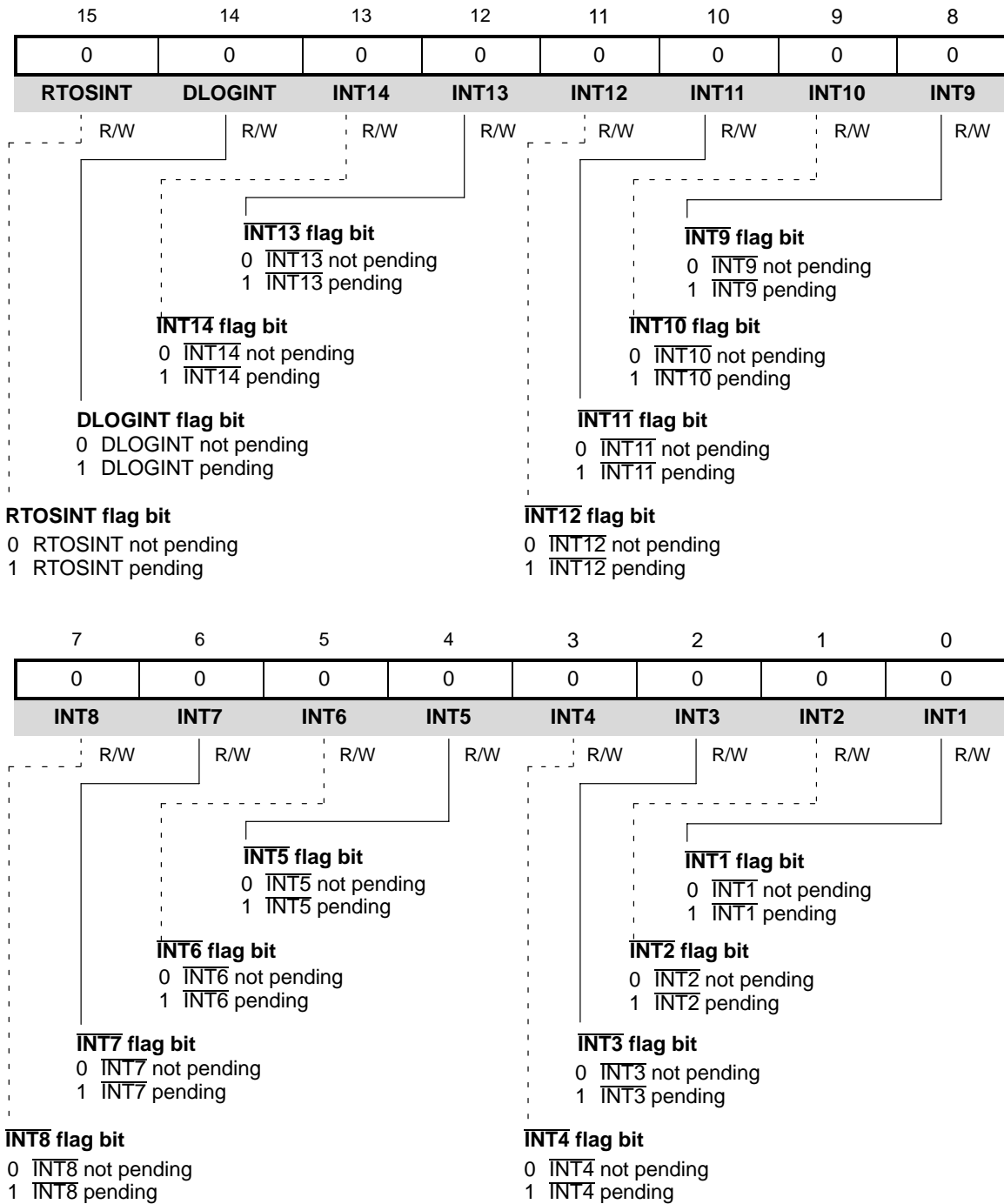


<sup>†</sup> These reserved bits are always 0s and are not affected by writes.

<sup>‡</sup> The VMAP bit depends on the level of the VMAP input signal at reset. If the VMAP signal is low, the VMAP bit is 0 after reset; if the VMAP signal is high, the VMAP bit is 1 after reset. For C28x devices that do not pin out the VMAP signal, the signal is tied high internal to the device.

**Note:** For more details about ST1, see section 2.4 on page 2-34.

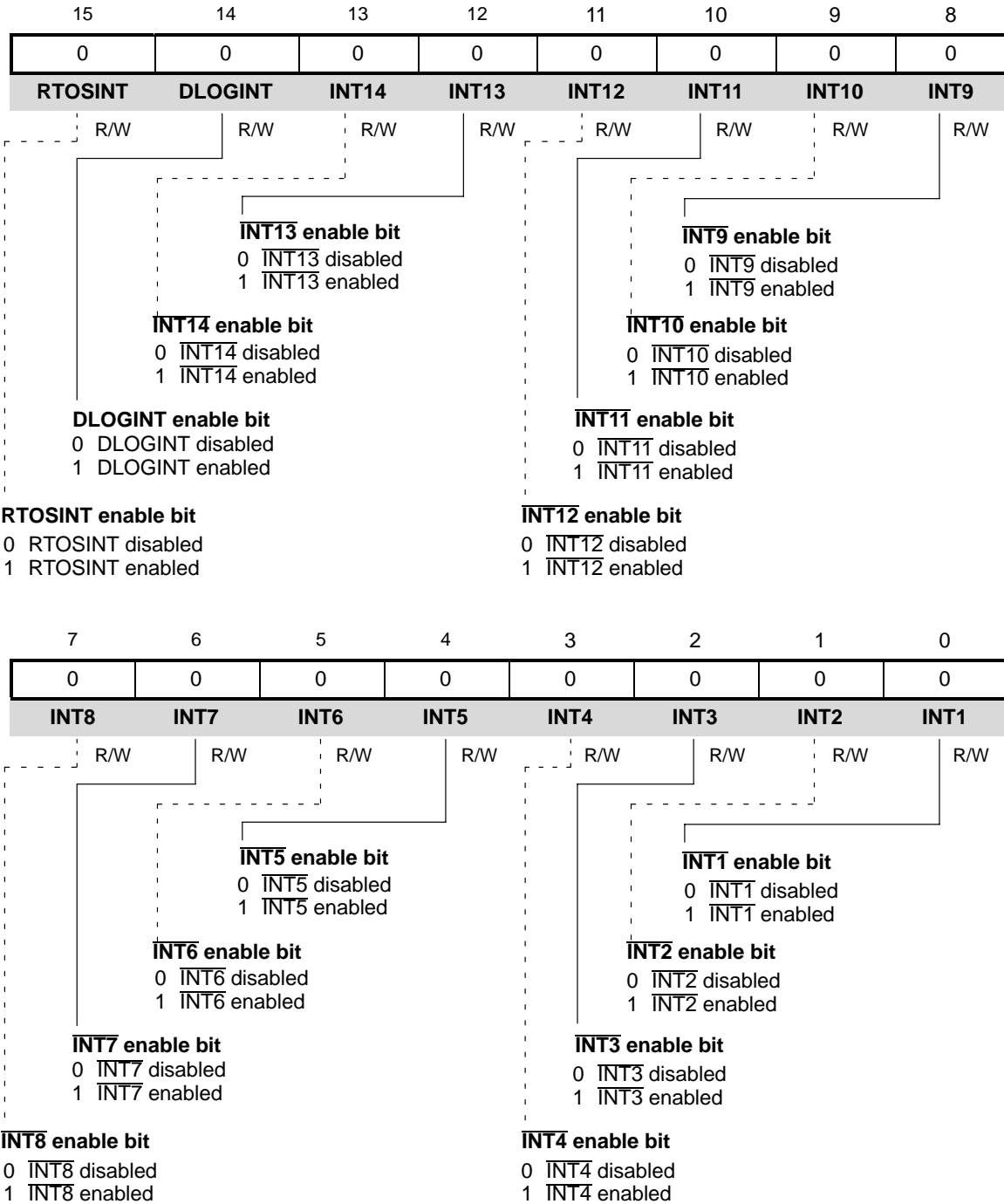
Figure A-4. Interrupt flag register (IFR)



**Note:** For more details about the IFR, see section 3.3.1 on page 3-7.

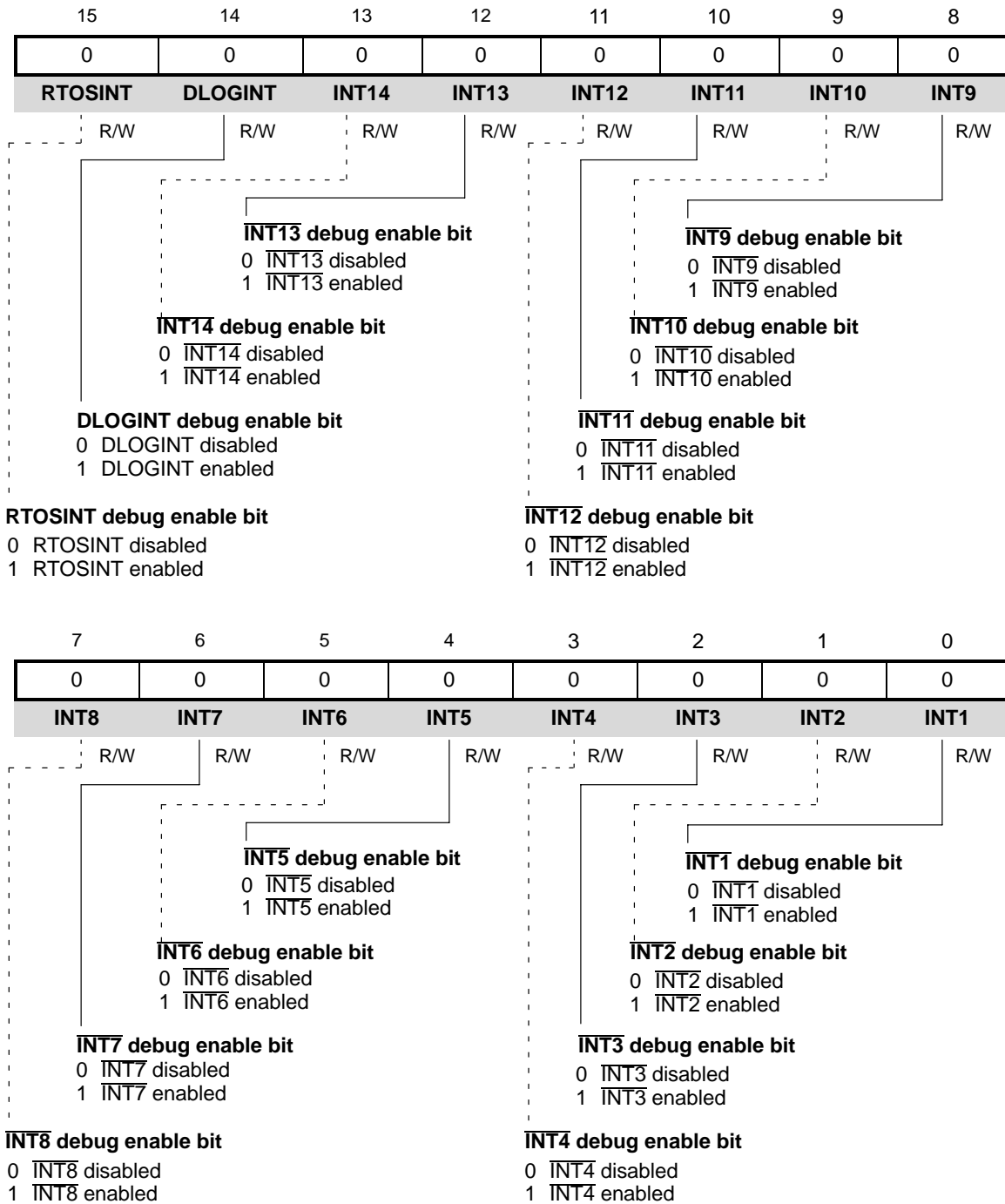


Figure A-5. Interrupt enable register (IER)



**Note:** For more details about the IER, see section 3.3.2 on page 3-8.

Figure A-6. Debug interrupt enable register (DBGIER)



**Note:** For more details about the DBGIER, see section 3.3.2 on page 3-8.

---

# **C2xLP and C28x Architectural Differences**

---

---

---

This appendix highlights some of the architecture differences between the C2xLP and the C28x. Not all of the changes are listed here. An emphasis is placed on those changes of which you need to be aware while migrating from a C2xLP-based design to a C28x design. In particular changes in CPU registers and memory map are addressed.

<b>Topic</b>	<b>Page</b>
<b>B.1 Summary of Architecture Differences Between C2xLP and C28x ..</b>	<b>B-2</b>
<b>B.2 Registers .....</b>	<b>B-3</b>
<b>B.3 Memory Map .....</b>	<b>B-12</b>

## B.1 Summary of Architecture Differences Between C2xLP and C28x

The C28x CPU features many improvements over the C2xLP CPU. A summary of the enhancements is given here.

Table B–1. General Features

Feature	C2xLP	C28x
Program memory space	64K (16 address signals)	4M (22 address signals)
Data memory space	64K (16 address signals)	4G (32 address signals)
Number of internal buses	3 (prog, data-read, data-write)	3 (prog, data-read, data-write)
Addressable word size	16	16/32
Multiplier	16 bits	16/32 bits
Maskable CPU interrupts	6	14

### B.1.1 Enhancements of the C28x over the C2xLP:

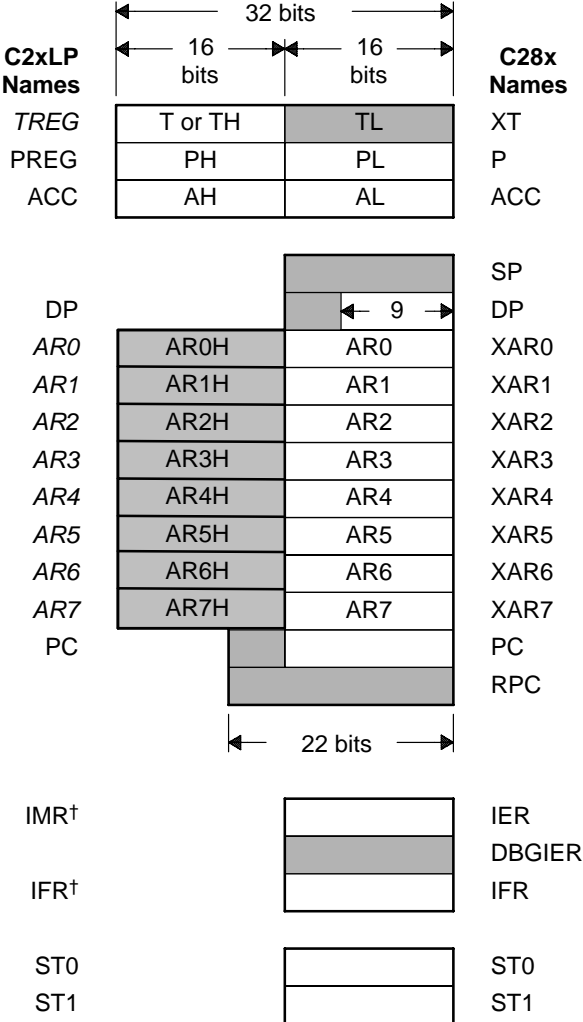
- Much higher MHz operation
- 32 x 32 MAC
- 16 x16 Dual MAC
- 32-bit register file
- 32-bit single-cycle operations
- 4M linear program-address reach
- 4G linear data-address reach
- Dedicated software stack pointer
- Monitorless real-time emulation
- 40–50% better C code efficiency than C2xLP
- 20–30% better assembly code efficiency than C2xLP
- Atomic operation eliminates need to disable/re-enable interrupts
- Extended debugging features (Analysis block, data logging, etc.)
- Faster interrupt context save/restore
- More efficient addressing modes
- Unified memory map
- Byte packing and unpacking operations

When you first recompile your C2xLP code set for C28x, you will not be able to take advantage of every enhancement since you are limited by the original source code. Once you begin migrating your code, however, you will quickly begin to take advantage of the full capabilities the C28x offers. See Appendix D for help with migration to C28x.

### B.2 Registers

The register modifications to the C2xLP are shown in Figure B-1. Registers that are shaded show the changes or enhancements on the C28x. The italicized names on the left are the original C2xLP names for the registers. The names on the right are the C28x names for the registers.

Figure B-1. Register Changes From C2xLP to C28x



<sup>†</sup>On the C2xLP, IMR and IFR were memory mapped. On the C28x, they are registers.

## B.2.1 CPU Register Changes

A brief description of the register modifications is given below. For a complete description of each register, see descriptions in the C2xLP and C28x Reference Guides.

<b>XT</b>	<b>Multiplicand register.</b> The 32-bit multiplicand register is called XT on the C28x. The C2xLP TREG is represented by the upper 16 bits (T). The lower 16 bit area is known as TL. The assembler will also accept TH in place of T for the upper 16 bits of the XT register.
<b>P</b>	<b>Product register.</b> This register is the same as the C2xLP PREG. You can separately access the high half (PH) or the low half (PL) on the C28x
<b>ACC</b>	<b>Accumulator.</b> The size of ACC is the same on the C28x. Access to the register has been enhanced. On C28x, you can access it as two 16-bit registers (AL and AH).
<b>SP</b>	<b>Stack Pointer.</b> The SP is new on the C28x. It points directly to the C28x software stack
<b>XAR0 – XAR7</b>	<b>Auxiliary registers.</b> All of the auxiliary registers (XARn) are increased to 32 bits on the C28x. This enables a full 32-bit address reach in data space. Some instructions separately access the low half of the registers (ARn).
<b>PC</b>	<b>Program counter.</b> The PC is 22 bits on C28x. On the C2xLP, the PC is 16 bits
<b>RPC</b>	<b>Return program counter.</b> The RPC register is new on the C28x. When a call operation is performed, the return address is saved in the RPC register and the old value in the RPC is saved on the stack. When a return operation is performed, the return address is read from the RPC register and the value on the stack is written into the RPC register. The net result is that return operations are faster (4 instead of 8 cycles). This register is only used when certain call and return instructions are used. Normal call and return instructions bypass this register.
<b>IER</b>	<b>Interrupt enable register.</b> The IER is analogous to the Interrupt Mask Register (IMR) on the C2xLP. It performs the same function, however, the name has changed to more appropriately describe the function of the register. Each bit in the register enables one of the maskable interrupts. On the C2xLP, there are six maskable CPU interrupts. On the C28x CPU, there are 16 CPU interrupts. On the C2xLP, the IMR was memory mapped.
<b>DBGIER</b>	<b>Debug interrupt-enable register.</b> The DBGIER is new on the C28x. It enables interrupts during debug events and allows the processor and debugger to perform real-time emulation.
<b>IFR</b>	<b>Interrupt flag register.</b> The IFR functions the same as on the C2xLP. There are more valid bits in this register to accommodate the additional interrupts on the C28x. On the C2xLP, the IFR was memory mapped.

<b>ST0/ST1</b>	<b>Status Registers.</b> The C28x status register bit positions are different compared to the C2xLP. Figure B-3 shows the differences.
<b>DP</b>	<b>Data Page Pointer.</b> On the C2xLP the DP is part of status register ST0. The DP on the C28x is a separate register and is increased from 9 to 16 bits.

## B.2.2 Data Page (DP) Pointer Changes

### B.2.2.1 C2xLP DP

The direct addressing mode on the C2xLP can access any data memory location in the 64K address range of the device using a 9-bit data page pointer and a 7-bit offset, supplied by the instruction, which is concatenated with the data page pointer value to form the 16-bit data address location. An example C2xLP operation is as follows:

```
LDP #VarA      ; Load DP with page location for VarA
LACL VarA      ; Load ACC low with contents of VarA
```

The first instruction initializes the DP register value with the "page" location for the specified variable. Each page is 128 words in size. The assembler/linker automatically resolve the page value by dividing the absolute address of the specified location by 128. For example:

```
If "VarA" address = 0x3456, then the DP value is:
DP(8:0) = 0x3456/128 = 0x69
```

The next instruction will then calculate the 7-bit offset of the specified variable within the 128-word page. This offset value is then embedded in the address field for that instruction. The assembler/linker automatically resolves the offset value by taking the first 7 bits of the absolute address of the specified location. For example:

```
If "VarA" address = 0x3456, then the 7bit offset value is:
7-bit offset = 0x3456 & 0x007F = 0x56
```

### B.2.2.2 C28x DP

The C28x also supports the direct addressing mode using the DP register; however, the following changes and enhancements have been made:

- Supports 22-bit address reach
- DP increased from 9 to 16 bits
- DP is a separate 16-bit register
- When AMODE == 0, page size is 64 words and DP(15:0) is used
- When AMODE == 1, page size is 128 words and DP(15:1) is used, bit 0 of DP is ignored

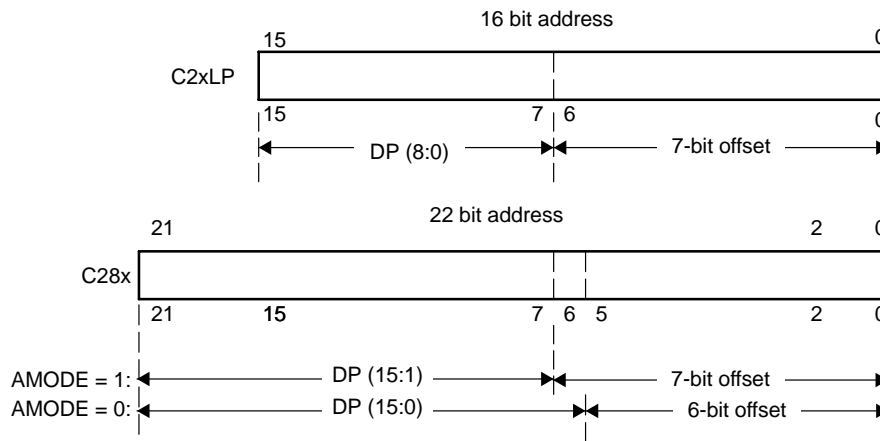
When AMODE == 1, the DP and the direct addressing mode behaves identically to the C2xLP but are enhanced to 22-bit address reach from 16. When



AMODE == 0, the page size is reduced by half. This was done to accommodate other useful addressing modes.

The mapping of the direct addressing modes between the C2xLP and the C28x is as shown in Figure B-2.

Figure B-2. Direct Addressing Mode Mapping



Using the previous example, the assembler/linker will initialize the DP and offset values as follows on the C28x:

**C2xLP Original Source Mode ("v28 -m20" mode, AMODE == 1)**

```
LDP #VarA      ; DP(15:0)      = 0x3456/128 << 1 = 0x00D1
LACL  VarA     ; 7-bit offset = 0x3456 & 0x007F = 0x56
```

**Equivalent C28x Mnemonics (after C2xLP source is reassembled with the C28x assembler)**

```
MOVZ  DP, #VarA ; DP(15:0)      = 0x3456/128 << 1 = 0x00D1
MOVU  ACC, @@VarA ; 7-bit offset = 0x3456 & 0x007F = 0x56
```

**C28x Addressing Mode ("v28" mode, AMODE == 0)**

```
MOVZ  DP, #VarA ; DP(15:0)      = 0x3456/64      = 0x00D1
MOVU  ACC, @VarA ; 6-bit offset = 0x3456 & 0x003F = 0x16
```

Note: When using C28x syntax, the 128 word data page is indicated by using the double "@@" symbol. The 64 word data page is indicated by the single "@" symbol. This helps the user and assembler to track which mode is being used.

## B.2.3 Status Register Changes

Figure B-3. Status Register Comparison Between C2xLP and C28x

### C2xLP Status Register ST0

15	14	13	12	11	10	9	8	7	6	5	4	3	2	1	0
ARP		OV		OVM		1	INTM		DP						
R/W-X		R/W-0		R/W-X		R/W-1		R/W-X							

**Note:** R = Read access; W = Write access; value following dash (-) is value after reset.

### C28x Status Register ST0

15	14	13	12	11	10	9	8	7	6	5	4	3	2	1	0
OVC/OVCU					PM			V	N	Z	C	TC	OVM	SXM	
R/W-000000					R/W-000			R/W-0	R/W-0	R/W-0	R/W-0	R/W-0	R/W-0	R/W-0	R/W-0

**Note:** R = Read access; W = Write access; value following dash (-) is value after reset.

### C2xLP Status Register ST1

15	14	13	12	11	10	9	8	7	6	5	4	3	2	1	0
ARB		CNF		TC	SXM	C	1	1	1	1	XF	1	1	PM	
R/W-X		R/W-0		R/W-X	R/W-1	R/W-1	R/W-1				R/W-00				

**Note:** R = Read access; W = Write access; value following dash (-) is value after reset.

### C28x Status Register ST1

7	6	5	4	3	2	1	0
IDLESTAT	EALLOW	LOOP	SPA	VMAP	PAGE0	DBGM	INTM
R-0	R/W-0	R-0	R/W-0	R/W-1	R/W-0	R/W-1	R/W-1

15-13	12	11	10	9	8
ARP	XF	MOM1MAP	Reserved	OBJMODE	AMODE
R/W-000	R/W-0	R-1	R/W-0	R/W-0	R/W-0

**Notes:** 1) R = Read access; W = Write access; value following dash (-) is value after reset; reserved bits are always 0s and are not affected by writes.

- Z**      **Zero flag.** Z is new on the C28x. It is involved in determining if the results of certain operations are 0. It is also used for conditional operations.
- N**      **Negative flag.** N is new on the C28x. It is involved in determining if the results of certain operations are negative. It is also used for conditional operations.
- V**      **Overflow flag.** V has changed names from OV on the C2xLP. It flags overflow conditions in the accumulator.
- PM**     **Product shift mode.** The PM has increased to a 3-bit register with additional capabilities. Below is a comparison of the PM register in the C2xLP and the C28x. Note that the register behaves differently depending on the operational mode of the C28x device. The XSPM instructions correspond to equivalent C2xLP instructions conversion. On the C2xLP, the PM bits corresponded to no shift at reset. On C28x, however, the PM corresponds to a left shift of 1 at reset.

Table B–2. C2xLP Product Mode Shifter

Bits	Shift Value	Instruction
00	no shift	SPM 0
01	shift left 1	SPM 1
10	shift left 4	SPM 2
11	shift right 6	SPM 3

Table B–3. C28x Product Mode Shifter

Bits	C2xLP Source-Compatible Mode AMODE == 1 OBJMODE = 1 PAGE0 == 0		C28x Mode AMODE == 0 OBJMODE = 1 PAGE0 == 0	
	Shift Value	Instruction	Shift Value	Instruction
000	shift left 1	SPM +1 (or SPM 1)	shift left 1	SPM +1
001	no shift	SPM 0 (or SPM 0)	no shift	SPM 0
010	shift right 1	SPM –1	shift right 1	SPM –1
011	shift right 2	SPM –2	shift right 2	SPM –2
100	shift right 3	SPM –3	shift right 3	SPM –3
101	shift left 4	SPM +4 (or SPM 2)	shift right 4	SPM –4
110	shift right 5	SPM –5	shift right 5	SPM –5
111	shift right 6	SPM –6 (or SPM 3)	shift right 6	SPM –6

---

<b>OVC:</b>	<b>Overflow counter.</b> OVC is new on the C28x. It can be viewed as an extension of the accumulator. For signed operations, the OVC counter is an extension of the overflow mode. For unsigned operations, the OVC counter (OVCU) is an extension of the carry mode.
<b>DBGM:</b>	<b>Debug enable mask bit.</b> DBGM is new on the C28x. It is analogous to the INTM bit and works in cooperation with the DBGIER register to globally enable interrupts in real-time emulation.
<b>PAGE0</b>	<b>PAGE0 addressing mode configuration bit.</b> The PAGE0 bit is new on the C28x. It is used for compatibility to the C27x and should be left as 0 for users moving from the C2xLP to C28x.
<b>VMAP</b>	<b>Vector map bit.</b> The VMAP bit is new on the C28x. It determines from where in memory interrupt vectors will be fetched.
<b>SPA</b>	<b>Stack pointer alignment bit.</b> The SPA bit is new on the C28x. It is a flag used to determine if aligning the stack pointer caused an adjustment in the stack pointer address.
<b>LOOP</b>	<b>Loop instruction status bit.</b> The LOOP bit is new on the C28x. It is used in conjunction with the LOOPZ/LOOPNZ instructions.
<b>EALLOW</b>	<b>Emulation access enable bit.</b> The EALLOW bit is new on the C28x. It allows access to the emulation register on the C28x.
<b>IDLESTAT</b>	<b>IDLE status bit.</b> The IDLESTAT bit is new on the C28x. It flags an IDLE condition on the C28x, and is mainly used when returning from an interrupt.
<b>AMODE</b>	<b>Address mode bit.</b> The AMODE bit is new on the C28x. This mode bit is used to select between C28x addressing mode (AMODE == 0) and C2xLP addressing mode (AMODE == 1).
<b>OBJMODE</b>	<b>Object mode bit.</b> The OBJMODE bit is new on the C28x. It is used to select between C27x object mode (OBJMODE == 0) and C28x object mode (OBJMODE == 1). For users moving from C2xLP to C28x, this bit should always be set to 1.  <b>Note:</b> Upon reset of the C28x, this bit is set to 0 and needs to be changed in firmware.
<b>M0M1MAP</b>	<b>M0 M1 map bit.</b> The M0M1MAP bit is new on the C28x. It is only used for C27x compatibility. For users transitioning from the C2xLP to C28x this bit should always be set to 1.
<b>XF</b>	<b>XF pin status bit.</b> The XF pin has the same function as on the C2xLP. Please note that the reset state has changed on the C28x.
<b>ARP</b>	<b>Auxiliary register pointer.</b> The ARP has the same functionality as on the C2xLP. It should, however, only be used when transitioning code to the C28x. The C28x has enhanced addressing modes which eliminate the need to keep track of the ARP.

The functionality of the remaining bits is the same on C28x as they are on C2xLP. It should be noted that although the functionality did not change, the bit position in the registers did. These bits are:

- Sign extension mode (SXM)
- Overflow mode (OVM)
- Test/control flag (TC)
- Carry bit (C)
- Interrupt global mask bit (INTM)

### B.2.4 Register Reset Conditions

The reset conditions of internal registers have changed between the C2xLP and C28x as shown in Table B-4. Most C28x registers are cleared on a reset.

Differences in Table B-5 are highlighted in **bold**.

Table B-4. Reset Conditions of Internal Registers

C2xLP Register	C2xLP Reset	C28x Register	C28x Reset
T	X	XT	0x00000000
P	X	P	0x00000000
ACC	X	ACC	0x00000000
AR0-AR7	X	XAR0-XAR7	0x00000000
PC	0x0000	PC	0x3FFFC0
ST0	See Table B-5	ST0	0x0000
ST1	See Table B-5	ST1	0x080B
DP	X	DP	0x0000
-	-	SP	0x0400
IMR	0x00	IER	0x0000
-	-	DBGIER	0x0000
IFR	0x0000	IFR	0x0000
GREG	0x0000	-	-
-	-	RPC	0x000000

X = Uninitialized

Table B-5. Status Register Bits

Reg	C2xLP Bit Name	C2xLP Reset Value	C28x Bit Name	C28x Reset Value
ST0	DP	XXXXXXXXXX	<b>SXM</b>	0
	INTM	1	OVM	0
	OVM	X	TC	0
	OV	0	<b>C</b>	0
	ARP	XXX	Z	0
			N	0
			V	0
			<b>PM</b>	000 (left shift 1)
ST1	<b>PM</b>	<b>00 (no shift)</b>	INTM	1
	XF	1	DBGM	1
	<b>C</b>	<b>1</b>	PAGE0	0
	<b>SXM</b>	<b>1</b>	VMAP	1
	TC	X	SPA	0
	CNF	0	LOOP	0
	ARB	XXX	EALLOW	0
			IDLESTAT	0
			AMODE	0
			OBJMODE	0
			CNF not implemented	0
			M0M1MAP	1
			XF	0
			ARP	000

### B.3 Memory Map

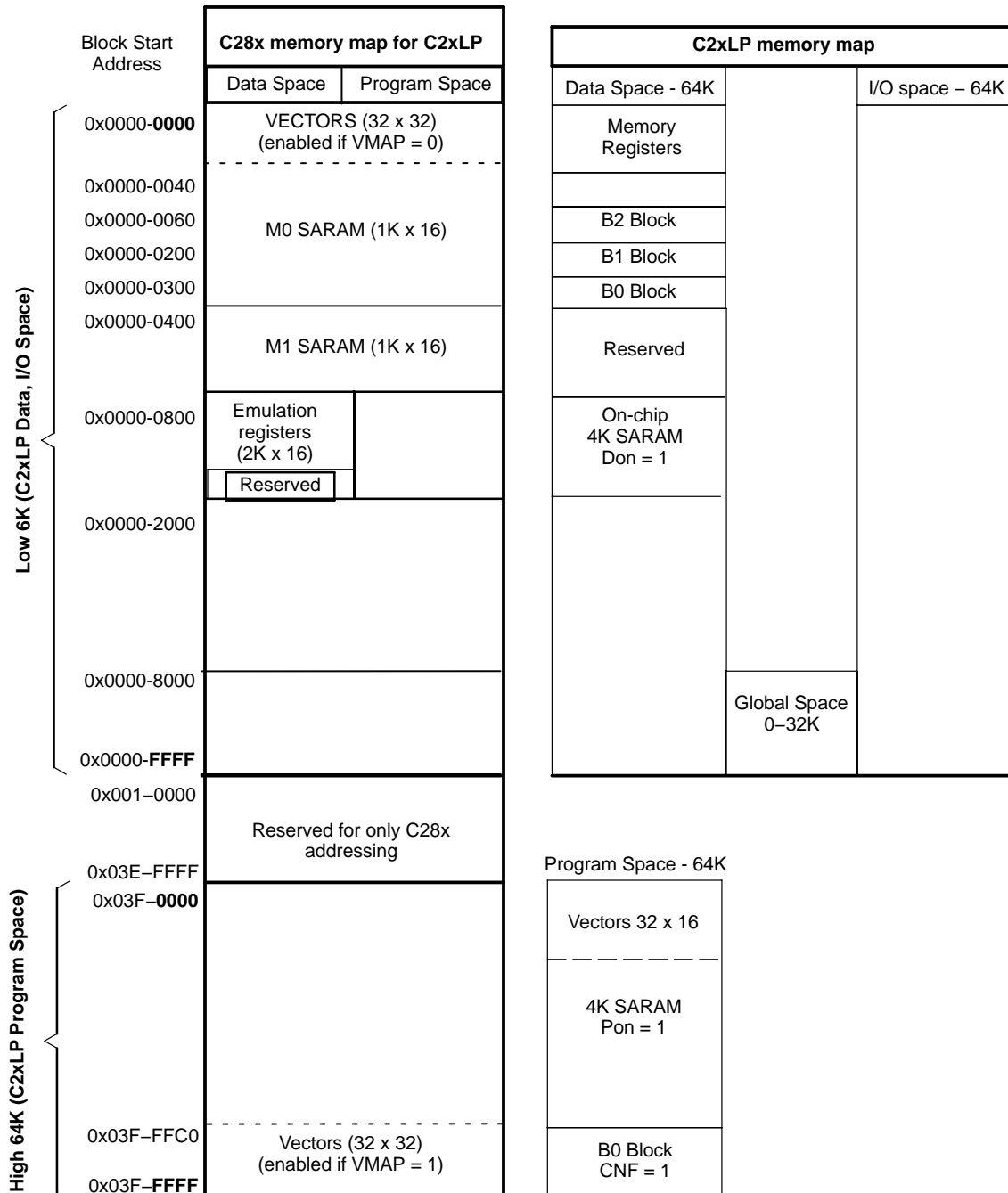
The major changes between the C2xLP and C28x memory maps are outlined in this section. There are several differences between the C2xLP and C28x memory maps. These improvements are due to the expanded architecture of the C28x. The C28x CPU memory map ranges from 4G to 4M in data and program memory, respectively. However, C28x CPU-based devices may not use the entire memory range. See the device data sheet for the specific memory range applicable to that device.

**Vectors.** On the C2xLP, only one vector table is present at address 0x0000. These vectors were generally branch instructions to different interrupt service routines. On the C28x, the vector table can be placed in two different locations depending on the state of the VMAP input pin. On devices that do not pin out the VMAP signal, it is tied internal to the device. Generally, vectors will be located in non-volatile memory at 0x3FFFC0–0x3FFFFFF. To take advantage of relocatable vectors or fetching vectors from fast internal memory space, place the vectors at address 0x000000–0x00003F. Often the C28x CPU interrupt vectors are expanded using external hardware logic. In such cases, see the related documents for the expanded vector map.

**Memory space.** On the C2xLP, the memory space for program, data, and I/O space is each 64K words. On the C28x, the program memory space is 4M words (22 address signals). The data memory space is 4G words (32 address signals). The global space (32K) and I/O space (64K) is generally used for C2xLP compatibility.

**Program space.** On the C2xLP CPU, program space could be mapped anywhere from (0x0–0xFFFF). With the extended address reach of the C28x (22 bits), the compatible region in program space for the C2xLP is 0x3F0000–0x3FFFFFF. Thus, any program memory on the C2xLP must be re-mapped to this upper region on the C28x. When the processor accesses program memory, the upper bits (bits 16–22) will be forced to all 1's when C2xLP-compatible instructions are used (See Appendix E).

Figure B-4. Memory Map Comparison (See Note A)



Note A: Memory map is not to scale.



**Data memory.** The C2xLP has three internal memory regions (B0, B1, B2) totaling 544 words. The C28x has two internal memory regions (M0,M1) totaling 1K words each. Note that for strict C2xLP compatibility, the memory regions are placed at the same addresses as noted in Table B–6.

Table B–6. B0 Memory Map

C28x in C2xLP-Compatible Mode	C2xLP
CNF Not Available	CNF = 0
B0 range mapped in M0 block 200 – 2FFh. (No mirroring of the block)	B0 in Data space 100 – 1FFh (mirrored locations) 200 – 2FFh
CNF Not Available	CNF = 1
B0 range cannot be enabled in C2xLP-equivalent program memory	B0 in program space FE00 – FEFFh (mirrored locations) FF00 – FFFFh

**I/O space.** I/O space has remained on the C28x for compatibility reasons, and can only be accessed using IN and OUT/UOUT instructions. Not all C28x devices will support I/O space. See the data sheet of your particular device for details.

**Global space.** Global space is not supported on all C28x devices. See the data sheet specific to your device for details.

**Reserved memory.** Reserved memory regions have changed on the C28x. No user-defined memory or peripherals are allowed at addresses 0x800–0x9FF on the C28x. While using C2xLP-compatible mode, these addresses are reserved. It is recommended that C2xLP memory or peripherals be relocated to avoid memory conflicts.

**Stack space.** The C28x has a dedicated software stack pointer. This pointer is initialized to address 0x0400 (the beginning of block M1) at reset, and it grows upward in address. It is up to the user to move this stack pointer if needed in firmware.

# **C2xLP Migration Guidelines**

---

---

---

The C28x DSP is source-code compatible with C2xLP DSP based devices. The C28x DSP assembler accepts all C2xLP mnemonics with the exception of a few instructions. This chapter provides guidelines for C2xLP code migration to a C28x device. C2xLP refers to the CPU used in all TMS320C24x, TMS320C24xx, and TMS320C20x DSP devices.

<b>Topic</b>	<b>Page</b>
<b>C.1 Introduction</b> .....	<b>C-2</b>
<b>C.2 Recommended Migration Flow</b> .....	<b>C-3</b>
<b>C.3 Mixing C2xLP and C28x Assembly</b> .....	<b>C-6</b>
<b>C.4 Code Examples</b> .....	<b>C-7</b>
<b>C.5 Reference Tables for Code Migration Topics</b> .....	<b>C-10</b>

## **C.1 Introduction**

This chapter provides guidelines that are intended for conversion from C2xLP assembly source to C28x object code. The conversion steps highlight the architectural changes between C2xLP and C28x operating modes. Future releases of documents will contain code conversion examples and software library modules facilitating the conversion from C2xLP mixed C and assembly source to C28x object code.

This chapter will be best understood if the reader has prior knowledge of Appendix C and Appendix E, as they explain the architectural and instructional enhancements between the C2xLP and C28x DSPs.

## C.2 Recommended Migration Flow

Use the following steps (shown in Figure C–1) to migrate code:

- 1) Install the latest development tools for the C28x DSP (e.g. Code Composer Studio™ version 2.x or higher)

- 2) Build the project with following C28x assembler options:

```
-m20          ; enable C2xLP instructions
- g           ; enable source level debug to view the C2xLP
              ; instructions
-mw          ; enable additional assembly checks
```

Code Composer Studio 2.x will assemble all C2xLP instructions and map all the compatible instructions to their equivalent C28x instructions and mnemonics. Code Composer Studio 2.x disassembly will display the instructions in the memory as C28x mnemonics only. If the source is built with `-g` option, the relevant C2xLP source file will be also displayed and will facilitate C2xLP instruction readability during debug.

- 3) **Memory map:**

Define your C28x device memory map with C2xLP compatible memory sections. Build a linker command file (\*.cmd). See Table C–8.

Select a C2xLP assembly source code \*.asm for migration to C28x architecture.

- 4) **Boot Code:**

Add the C2xLP mode conversion code segment shown in section C.4.1 as the first set of instructions after reset.

After reset, the C28x powers up in C27x object-compatible mode. Adding these few lines of initialization code will place the device in the proper operating mode for executing reassembled C2xLP code.

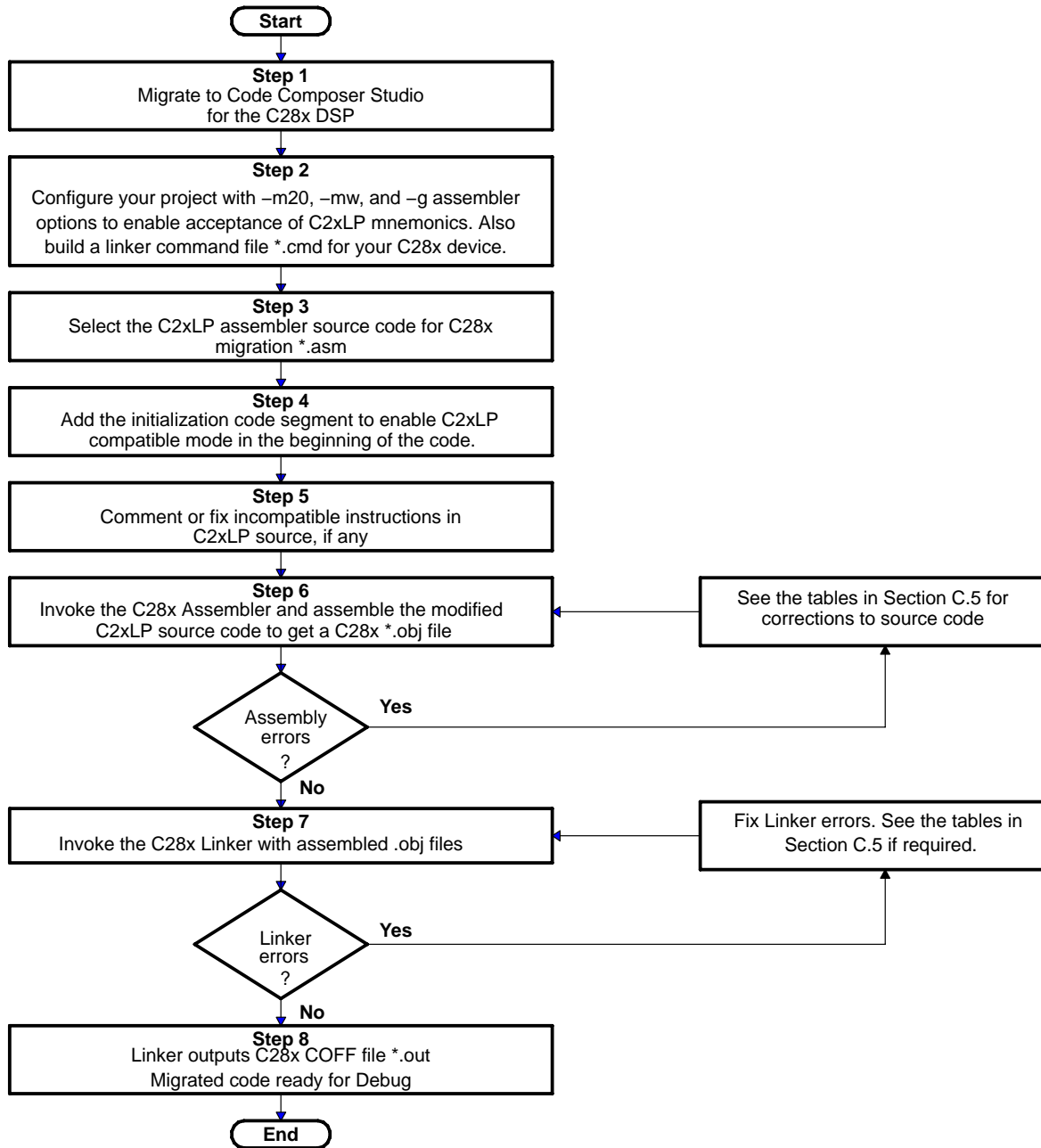
**Note:** The C27x object-compatible mode is for use only for migration from the C27x CPU. It is a reserved operating mode for all C28x and C2xLP applications.

- 5) This step will facilitate faster code conversion. In the C2xLP source file modify the interrupt section with suggestions from the reference table in section D.5.

In particular, modify the following types of code:

- a) **IMR and IFR** – See the example code in section C.4.2.
- b) **Context Save/Restore** – See the example code in section C.4.3
- c) Comment all the known incompatible instructions or map with equivalent instructions. See Table D–2 in Appendix D.

Figure C-1. Flow Chart of Recommended Migration Steps



Legend: \* represents user filename

- 6) Link the assembled code with the linker command file generated in Step 2. Relink if necessary to avoid any linker related errors.
- 7) Assemble or reassemble using the C28x assembler until the assembly is successful with no errors. The tables in section C.5 will help to resolve most of the errors during the assembly process. This will prepare a **\*.obj** file, ready for C28x Linker processing.
- 8) The Linker output COFF file, **\*.out**, will be the migrated code and should be ready for Debug and integration.

### C.3 Mixing C2xLP and C28x Assembly

At this point your original C2xLP code will be running on the C28x device. To facilitate further migration to C28x code, there are special assembler directives that will facilitate mixing of C2xLP code and C28x code segments.

The `.c28_amode` and `.lp_amode` directives tell the assembler to override the assembler mode.

**`.c28_amode`** The `.c28_amode` directive tells the assembler to operate in the C28x object mode (`-v28`).

**`.lp_amode`** The `.lp_amode` directive tells the assembler to operate in C28x object – accept C2xLP syntax mode (`-m20`).

These directives can be repeated throughout a source file.

For example, if a file is assembled with the `-m20` option, the assembler begins the assembly in the C28x object – accept C2xLP syntax mode. When it encounters the `.c28_amode` directive, it changes the mode to C28x object mode and remains in that mode until it encounters an `.lp_amode` directive or the end of file.

**Example** In this example, C28x code is inserted in the existing C2xLP code.

```
; C2xLP source code
.lp_amode
LDP    #VarA
LACL   VarA
LAR    AR0 *+, AR2
SACL   *+
.
.
CALL   FuncA
.
.
; The C2xLP code in function FuncA is replaced with C28x Code
; using C28x addressing (AMODE = 0)

.c28_amode    ; Override the assembler mode to C28x syntax
FuncA:
    C28ADDR           ; Set AMODE to 0 C28x addressing
    MOV    DP, #VarB
    MOV    AL, @VarB
    MOVL   XAR0, *XAR0++
    MOV    *XAR2++, AL
    .lp_amode           ; Change back the assembler mode to C2xLP.
    LPADDR           ; Set AMODE to 1 to resume C2xLP addressing.
    LRET
```

## C.4 Code Examples

### C.4.1 Boot Code for C28x operating mode initialization

**Note:** The following code fragment must be placed in your code just after reset. This code will place the device in the proper operating mode to execute C2xLP converted code:

Code	Explanation
SETC OBJMODE	;C28OBJ = 1 enable 28x object mode
CLRC PAGE0	;PAGE0 = 0 not relevant for 28x mode, ;cleared to zero
SETC AMODE	;AMODE = 1 enable C2xLP compatible ;addressing mode
SETC SXM	;SXM = 1 for C2xLP at reset, SXM = 0 ;for 28x at reset
SETC C	;Carry bit =1 for C2xLP at reset, ;Carry bit = 0 for 28x at reset
SPM 0	;Set product shift mode zero, that is PM bits = 001 compatible to ;C2xLP PM reset;mode

### C.4.2 IER/IFR Code

*Table C-1. Code to Save Contents Of IMR (IER) And Disabling Lower Priority Interrupts At Beginning Of ISR*

C2xLP	C28x
INTx: . MAR * ,AR1 LDP #0 LACL IMR SACL *+ AND #~INT_MASK SACL IMR . .	INTx: . AND IER,#~INT_MASK .  Note: C28x saves IER as part of automatic context save operation and disables the current interrupt automatically to prevent recursive interrupts.

*Table C-2. Code to Disable an Interrupt*

C2xLP	C28x
SETC INTM LDP #0 LACL IMR AND #~INTx SACL IMR CLRC INTM	AND IER,#~INTx  ;operation is atomic and ;will not be interrupted.



Table C-3. Code to Enable an Interrupt

C2xLP	C28x
<pre>SETC  INTM       LDP  #0       LACL IMR       OR   #INTx       SACL IMR CLRC  INTM</pre>	<pre>OR      IER, #INTx ;operation is atomic and ;will not be interrupted.</pre>

Table C-4. Code to Clear the IFR Register

C2xLP	C28x
<pre>;write 1 to clear       SETC  INTM       LDP  #0       SPLK #0FFFFh, IFR CLRC  INTM</pre>	<pre>;write 0 to clear       AND   IFR, #~INTx ;operation is atomic and ;will not be interrupted</pre>

### C.4.3 Context Save/Restore

The C28x automatically saves a number of registers on each interrupt. To perform a full context save, some additional code must be added. Table C-5 shows a typical full context save and restore for both processors.

Table C-5. Full Context Save/Restore Comparison

C2xLP Full Context Save/Restore	C28x Full Context Save/Restore
<pre> INTx_ISR: ; context save     MAR    *, AR1     MAR    *+     SST    #1, *+     SST    #0, *+     SACH   *+     SACL   *+     SPH    *+     SPL    *+     MPY    #1     SPL    *+     SAR    AR0, *+     SAR    AR2, *+     SAR    AR3, *+     SAR    AR4, *+     SAR    AR5, *+     SAR    AR6, *+     SAR    AR7, *+     .     ;interrupt code goes here     .     . ; context restore     MAR    *, AR1     MAR    *-     LAR    AR7, *-     LAR    AR6, *-     LAR    AR5, *-     LAR    AR4, *-     LAR    AR3, *-     LAR    AR2, *-     LAR    AR0, *-     SETC   INTM     MAR    *-     SPM    0     LT     *+     MPY    #1     LT     *-     MAR    *-     LPH    *-     LAACL  *-     ADD    *-, 16     LST    #0, *-     LST    #1, *-     CLRC   INTM     RET </pre>	<pre> ;C28x automatically saves the ;following registers: ;T,ST0,AH,AL,PH,PL,AR1,AR0,DP,ST1, ;DBGSTAT,IER,PC  INTx_ISR: ;interrupt context save     PUSH   AR1H:AR0H    ; 32-bit     PUSH   XAR2         ; 32-bit     PUSH   XAR3         ; 32-bit     PUSH   XAR4         ; 32-bit     PUSH   XAR5         ; 32-bit     PUSH   XAR6         ; 32-bit     PUSH   XAR7         ; 32-bit     PUSH   XT           ; 32-bit     .     .     ;interrupt code goes here     .     . ;interrupt context restore     POP    XT     POP    XAR7     POP    XAR6     POP    XAR5     POP    XAR4     POP    XAR3     POP    XAR2     POP    AR1H:AR0H     IRET </pre>

## C.5 Reference Tables for C2xLP Code Migration Topics

Table C–6 through Table C–10 explain the major differences between the C2xLP and C28x architectures and in their respective code generation process. These tables are organized to highlight the differences in interrupts, CPU registers, memory maps, instructions, registers, and syntax. While migrating the C2xLP code, check the tables for these key differences to make the necessary changes to the source to avoid assembler or linker errors.

Table C–6. C2xLP and C28x Differences in Interrupts

	Migration topic	C2xLP	C28x
1	Interrupt flag register	IFR – Memory mapped register Write 1 to clear bits set in IFR	IFR is a CPU register Write 0 to clear bits set in IFR
2	Interrupt enable register	IMR – Memory mapped register	Renamed as IER and is a CPU register
3	TRAP instruction	Only one TRAP vector TRAP Affects: INTM bit is not affected	multiple, 32– TRAP vectors TRAP 0, .. TRAP31 Affects: INTM bit is set to 1
4	INTR instruction syntax	INTR0 .. INTR31 Affects: IFR not cleared IMR not affected INTM bit =1	INTR INT0 .... INTR INT31 Affects: IFR cleared IER affected INTM bit =1
5	NMI Instruction	NMI	TRAP NMI
6	CLRC INTM instruction	CLRC INTM instruction blocks all interrupts until the next instruction is executed. CLRC INTM next_instn ;interrupts ;blocked ;until this ;executed	Interrupts enabled after the instruction CLRC INTM
7	Interrupt enable and return from interrupt service	CLRC INTM RET	IRET

Table C–6. C2xLP and C28x Differences in Interrupts (Continued)

	Migration topic	C2xLP	C28x
8	Interrupt enable and return from function call	CLRC INTM next_instn	next_instn CLRC INTM
9	Interrupts Vector	Uses Branch statements at the vector address. Ex: B Start ;assembly ;code  opcode in memory 0x7980 ;branch ;instruction 0x0040 ;branch ;address	32-bit absolute addresses. ; code in vector location 0x0040 (low address) 0x003F (high address)
10	Context save	No automatic context save See section D.3 for a full context save/restore example	Automatic context save of CPU registers T, ST0, AH, AL, PH, PL, AR1, AR0, DP, ST1, DBGSTAT, IER, PC See Table C–5 for a full context save/restore example

Table C–7. C2xLP and C28x Differences in Status Registers

	Migration topic	C2xLP	C28x
1	Saving ST0/ST1 registers	Save: SST #0,mem ;store ST0 SST #1,mem ;store ST1 Restore: LST #0,mem ;load ST0 LST #1,mem ;load ST1	Save: PUSH ST ;store ST0 to stack PUSH ST ;store ST1 to stack Restore: POP ST1 ;load ST1 ;from stack POP ST0 ;load ST0 ;from stack
2	ST0/ST1 bit differences	ST0/ST1 bits have CPU registers and status bits	ST0/ST1 bits are rearranged compared to C2xLP registers.

Table C-7. C2xLP and C28x Differences in Status Registers (Continued)

3	INTM bit in ST0	Cannot be saved if ST0 register is saved	Saved along with ST0 register
4	Data page pointer DP save	DP save/restored along with ST0. SST #0,mem ;store ST0  LST #0,mem ;load ST0	DP is a register, hence explicit store/restore is required. PUSH DP ;store DP ;to stack PUSH DP:ST1 ; 32-bit ; save POP DP ;load DP from ;stack POP DP:ST1 ; 32-bit ; restore

Table C-8. C2xLP and C28x Differences in Memory Maps

Migration topic		C2xLP	C28x
1	Program memory	16-bit address Size : 64kx16 Range :0x0000-0xFFFFh	22 – bit address Size : 64kx16 mapped to Range : 0x3F 0000h – 0x3F FFFFh
2	Data memory	Size : 64kx16 Range :0x0000-0xFFFFh	Size : 64kx16 mapped to Range : 0x00 0000h – 0x00 FFFFh
6	B2 Block	Size: 32 words Range: 0x0060-0x007F	Located in M0 Block 1Kx16 Size: 1K words Range: 0x00 0060 –0x00 07Fh
7	B1 Block	Size: 256 words Range: 0x0100-0x01FF (mirrored) : 0x0200-0x02FF	Located in M0 Block – 1Kx16 Not Mirrored Range: 0x00 0200 –0x00 02FFh
8	B0 Block	Mirrored locations Size: 256 words Range: 0x0300-0x03FF : 0x0400-0x04FF	Located in M0 Block – 1Kx16 Not Mirrored Range: 0x00 0300 –0x00 03FFh

Table C–8. C2xLP and C28x Differences in Memory Maps (Continued)

Migration topic		C2xLP	C28x
9	CNF bit mapping of B0 Block	CNF bit maps B0 in data and program memory CNF =0 – B0 in data memory Range: 0x0300–0x03FF : 0x0400–0x04FF CNF =1 – B0 in program memory Range: 0xFE00–0xFEFF : 0xFF00–0xFFFF	Not applicable
10	Vector table range	Size: 32x16 words Range: 0x0000–0x003F	Size 32x32 words 0x3F FFC0 – 0x3F FFFF – at reset In C28x based DSP devices may use additional expanded vector table (e.g., PIE)
11	Internal SARAM mapping in data memory	Mapped as internal memory map	Reserved for emulation registers Range : 0x0800 –0x1000h
5	I/O space	Range : 0x0000 –0xFFFFh	Range : 0x0x00 000 –0x00 FFFFh I/O Space may or may not be implemented on a particular device. See the device datasheet for details.
6	Global space	Range : 0x8000 –0xFFFFh	Implemented via the XINTF Global Space may or may not be implemented on a specific C28x device. See the device datasheet for details.

Table C–9. C2xLP and C28x Differences in Instructions and Registers

Migration topic		C2xLP	C28x
1	Conditional Instructions Branches, Calls, Returns	Can take more than one condition in these instructions	The C28x assembler will automatically break the instructions into multiple instructions.
2	When are CPU Flags updated?	Conditional flags update on Accumulator operation only	Conditional flags update on Accumulator, register and memory operations
3	Repeat instructions	Many instructions are repeatable	Same instructions are repeatable. For additional repeatable instructions see Table D–3.

Table C–9. C2xLP and C28x Differences in Instructions and Registers (Continued)

Migration topic		C2xLP	C28x
4	GREG register	Memory mapped register	Memory mapped register in XINTF Global Space may or may not be implemented on a particular device. See the device data sheet for details.
5	ARx registers	ARx registers are 16-bit only  LAR AR1, #0FFFFh ADRK #1  Result: AR1 = 0x0000h	XARn registers are 32 bits. Some instructions access only the lower 16 bits known as ARn MOV XAR1, #0FFFFh ADD XAR1, #1  Result: XAR1 = 0x10000h
6	2s complement subtraction to ARx	LAR AR1, #0FFFFh ADRK #0FE  Result: AR1 = 0xFFFFDh	MOV XAR1, #0FFFFh ADD XAR1, #0FE  Result: XAR1 = 0x1FFFDh
7	I/O instructions	Supports IN, OUT instructions	Supports IN, OUT, UOUT  I/O Space may or may not be implemented on a particular device. See the device datasheet for details.
8	Stack	Uses 8-deep Hardware stack C2xLP Compiler uses AR1 as Stack Pointer	Uses software stack pointer register (SP)  Compiler will use SP register, as stack pointer
9	Program counter	16 bits in size  B 5000h ; Branch to 5000 ; address	22 bits in size  The C28x assembler will use special C2xLP compatible instructions that force the upper program address lines to 0x3F thus creating a 16-bit C2xLP compatible PC.  B 0x3F5000 ;  or  XB 5000h

Table C-10. Code Generation Tools and Syntax Differences

Migration topic		C2xLP	C28x
1	Mnemonic	Source or destination not always specified. LACL, source SACL, destination	Instructions are always of the form mnemonic destination, source MOV destination,source
2	Direct addressing syntax -@ symbol	LACL dma	MOV ACC, @@dma ; C2xLP mode MOV ACC, @dma ; 28x mode @@ – means 128 word data page  @ – means 64 word data page
3	Indirect address pointer buffer, ARB	In indirect addressing, Auxiliary register will be pointed by ARP register in ST0. ARB is ARP pointer buffer in ST1. MAR *,AR2 ; ARP =AR2 LACL *	No ARB equivalent in 28x. Selected ARx is referenced in the instruction itself. MOV ACC,*AR2
4	New Address pointers syntax – *(0	BLDD #4545h,RegA	MOV @REGA, *(0:0x4545)
5	Repeat instructions syntax change –	No additional syntax RPT #5 NOP	Uses    syntax with repeat instructions RPT #5    NOP
6	Reserved register names Application code should not use these reserved words	ST0, ST1, IFR, IMR, GREG	ST0, ST1, AH, AL, PH, PL,T, TL, XAR0, XAR1, XAR2, XAR3, XAR4, XAR5, XAR6, XAR7, DP, ST1, DBGSTAT, IER, PC, RPC
7	Increment/Decrement syntax change	MAR *,AR2 LACL *+ .... LACL *-	MOV ACC, *AR2++ ..... MOV ACC, *AR2--
8	Shift syntax change	LACL dma, 4	MOV ACC,dma <<4



Table C-10. Code Generation Tools and Syntax Differences (Continued)

Migration topic		C2xLP	C28x
9	Number radix usage	x .set 09 ;Assembler ;accepts ;this as ;decimal 9	x .set 9 Avoid leading zeros, else the assembler will be use this as octal number.
10	Order of precedence in expressions – Syntax change	Expressions in assembly statements do not require parenthesis. x .set A<<B = C>>D	Expressions in assembly statements do require parenthesis. x .set (A<<B = C>>D)
11	Tools Directives	.mmregs ; reserved register use .port .globl	not applicable not applicable .global
12	Macros	Useful in coding style	Useful in coding style All C2xLP Macros are not directly used Convert them individually to 28x mode.
13	Assembler options	-v2xx	-m20, -v28

# **C2xLP Instruction Set Compatibility**

---

---

---

This appendix highlights the differences in syntax between the C2xLP and the C28x instructions, and details which C2xLP compatible instructions are repeatable on the C28x. The C28x assembler accepts both C28x and C2xLP assembly source syntax. This enables you to quickly port C2xLP code with minimal effort. Additionally, all compatible C2xLP instructions have an equivalent C28x style syntax. The C28x disassembler will show the C28x equivalent syntax.

<b>Topic</b>	<b>Page</b>
<b>D.1 Condition Tests on Flags</b> .....	<b>D-2</b>
<b>D.2 C2xLP vs. C28x Mnemonics</b> .....	<b>D-3</b>
<b>D.3 Repeatable Instructions</b> .....	<b>D-9</b>

## D.1 Condition Tests on Flags

On the C28x, all EQ/NEQ/GT/LT/LEQ conditional tests are performed on the state of the Z and N flags. On the C2xLP, the same condition tests are performed on the contents of the ACC register.

Table D–1. C28x and C2xLP Flags

Designation	C28x Modes	C2xLP Equivalent
NEQ	!= 0	ACC != 0
EQ	== 0	ACC == 0
GT	> 0	ACC > 0
GEQ	>= 0	ACC >= 0
LT	< 0	ACC < 0
LEQ	<= 0	ACC <= 0
HI	higher	–
HIS, C	higher or same, carry set	C == 1
LO, NC	lower, carry clear	C == 0
LOS	lower or same	–
NOV	no overflow	OV == 0
OV	overflow	OV == 1
NTC	TC == 0	TC == 0
TC	TC == 1	TC == 1
NBIO	test BIO input == 0	BIO == 0
UNC	unconditional	UNC

On the C28x, the Z and N flags are set on all ACC operations. That includes ACC loads. Therefore, the Z and N flags reflect the current state of the ACC immediately after an operation on the ACC.

## D.2 C2xLP vs. C28x Mnemonics

Table D–2 lists the C2xLP instructions with the C28x equivalent syntax. The C28x assembler will accept either the C2xLP syntax or the equivalent C28x syntax. The disassembler will decode and display the C28x syntax.

The C2xLP cycle count numbers shown are for zero wait-state internal memory, where  $n$  equals the number of repetitions (i.e., if an instruction is repeated, using the RPT instruction for repeatable instructions,  $n$  times it is executed  $n+1$  times).

Table D–2. C2xLP Instructions and C28x Equivalent Instructions

C2xLP				C28x			
Instruc- tion	Mnemonic	Cycles	Size	Instruc- tion	Mnemonic	Cycles	Size
ABS		$n+1$	16	ABS	ACC	1	16
ADD	loc16 [,0]	$n+1$	16	ADD	ACC,loc16 {<<0}	$n+1$	16
ADD	loc16,1..15	$n+1$	16	ADD	ACC,loc16 << 1..15	$n+1$	32
ADD	loc16,16	$n+1$	16	ADD	ACC,loc16 << 16	$n+1$	16
ADD	#8bit	1	16	ADDB	ACC,#8bit	1	16
ADD	#16bit [,0..15]	2	32	ADD	ACC,#16bit {<<0..15}	1	32
ADDC	loc16	$n+1$	16	ADDCU	ACC,loc16	1	16
ADDS	loc16	$n+1$	16	ADDU	ACC,loc16	$n+1$	16
ADDT	loc16	$n+1$	16	ADD	ACC,loc16 << T	$n+1$	32
ADRK	#8bit	1	16	ADRK	#8bit	1	16
AND	loc16	$n+1$	16	AND	ACC,loc16	$n+1$	16
AND	#16bit,16	2	32	AND	ACC,#16bit<<16	1	32
AND	#16bit [,0..15]	2	32	AND	ACC,loc16 {<< 0..15}	1	32
APAC		$n+1$	16	ADDL	ACC,P<<PM	$n+1$	16
B	pma	4	32	XB	pma,UNC	7	32
B	pma,*,ARn	4	32	XB	pma,*,ARPn	4	32
B	pma,*ind	4	32	NOP XB	*ind pma, UNC	8	32
B	pma,*ind,ARn	4	32	NOP XB	*ind pma,*,ARPn	5	48

† True/False

Condition Tests on Flags

Table D–2. C2xLP Instructions and C28x Equivalent Instructions (Continued)

C2xLP				C28x			
Instruc- tion	Mnemonic	Cycles	Size	Instruc- tion	Mnemonic	Cycles	Size
BACC		4	16	XB	*AL	7	16
BANZ	pma,*ind[,ARn]	4/2	32	XBANZ	pma,*ind[,ARAPn]	4/2	32
<b>BANZ</b>	<b>pma,*BR0+/*BR0-[,ARn]</b>	<b>4/2</b>	<b>32</b>	<b>Not applicable</b>			
BCND	pma[,COND]	4/2	32	XB or SB	pma,COND #8bitOff,COND	7/4	32 16
BCND	pma,COND1,COND2,..., CONDn	4/2	32	SB SB . XB skip:	skip,opposite of COND1 skip,opposite of COND2 . pma,CONDn	7+	48+
BIT	loc16,15-bit	n+1	16	TBIT	loc16,#bit	1	16
BITT	loc16	n+1	16	TBIT	loc16,T	1	32
BLDD	#src_addr,loc16	n+3	32	MOV	loc16,*(0:src_addr)	n+2	32
BLDD	loc16,#dest_addr	n+3	32	MOV	*(0:dest_addr),loc16	n+2	32
BLPD	#pma,loc16	n+3	32	XPREAD	loc16,*(pma)	n+2	32
CALA		4	16	XCALL	*AL	7	16
CALL	pma	4	32	XCALL	pma,UNC	7	32
CALL	pma*,ARn	4	32	XCALL	pma*,ARPn	4	32
CALL	pma,*ind	4	32	NOP XCALL	*ind pma,UNC	8	48
CALL	pma,*ind,ARn	4	32	NOP XCALL	*ind pma*,ARPn	5	48
CC	pma,COND	4/2	32	XCALL	pma,COND	7/4	32
CC	pma,COND1,...,CONDn	4/2	32	SB SB . XCALL skip:	skip,opposite of COND1 skip,opposite of COND2 . pma,CONDn	7+	48+
<b>CLRC</b>	<b>INTM</b>	<b>n+1</b>	<b>16</b>	<b>See Table C-6.</b>			

† True/False

Table D–2. C2xLP Instructions and C28x Equivalent Instructions (Continued)

C2xLP				C28x			
Instruc- tion	Mnemonic	Cycles	Size	Instruc- tion	Mnemonic	Cycles	Size
CLRC	XF/OVM/SXM/TC/C	n+1	16	CLRC	XF/OVM/SXM/TC/C	2, 1	16
<b>CLRC</b>	<b>CNF</b>	<b>n+1</b>	<b>16</b>	<b>Not applicable</b>			
CMPL		n+1	16	NOT	ACC	1	16
CMPR	0/1/2/3	n+1	16	CMPR	0/1/2/3	1	16
DMOV	loc16	n+1	16	DMOV	loc16	n+1	16
IDLE		1	16	IDLE		5	16
IN	loc16, PA	2 (n+1)	32	IN	loc16, * (PA)	n+2	32
<b>INTR</b>	<b>K</b>	<b>4</b>	<b>16</b>	<b>Not applicable</b>			
LACC	loc16 [, 0]	n+1	16	MOV	ACC, loc16 [<< 0]	1	16
LACC	loc16, 1..15	n+1	16	MOV	ACC, loc16 << 1..15	1	32
LACC	loc16, 16	n+1	16	MOV	ACC, loc16 << 16	1	16
LACC	#16bit, 0..15	2	32	MOV	ACC, #16bit << 0..15	1	32
LACL	loc16	n+1	16	MOVU	ACC, loc16	1	16
LACL	#8bit	1	16	MOVB	ACC, #8bit	1	16
LACT	loc16	n+1	16	MOV	ACC, loc16 << T	1	32
LAR	ARn, loc16	2 (n+1)	16	MOVZ	ARn, loc16	1	16
LAR	ARn, #8bit	2	16	MOVB	XARn, #8bit	1	16
LAR	ARn, #16bit	2	32	MOVL	XARn, #22bit	1	32
<b>LDP</b>	<b>loc16</b>	<b>2 (n+1)</b>	<b>16</b>	<b>Not applicable</b>			
LDP	#9bit	2	16	MOVZ	DP, #10bit >> 1	1	16
LPH	loc16	n+1	16	MOV	PH, loc16	1	16
<b>LST</b>	<b>#0/1, loc16</b>	<b>2 (n+1)</b>	<b>16</b>	<b>See Table C-7</b>			
LT	loc16	n+1	16	MOV	T, loc16	1	16
LTA	loc16	n+1	16	MOVA	T, loc16	n+1	16

† True/False

Table D-2. C2xLP Instructions and C28x Equivalent Instructions (Continued)

C2xLP				C28x			
Instruc- tion	Mnemonic	Cycles	Size	Instruc- tion	Mnemonic	Cycles	Size
LTD	loc16	n+1	16	MOVAD	T, loc16	1	16
LTP	loc16	n+1	16	MOVP	T, loc16	1	16
LTS	loc16	n+1	16	MOVS	T, loc16	n+1	16
MAC	pma, loc16	n+3	32	XMAC	P, loc16, * (pma)	n+2	32
MACD	pma, loc16	n+3	32	XMACD	P, loc16, * (pma)	n+2	32
MAR	*ind[, ARn]	n+1	16	NOP	*ind[, ARPn]	n+1	16
MPY	loc16	n+1	16	MPY	P, T, loc16	1	16
MPY	#13bit	1	16	MPY	P, @T, #16bit	1	32
MPYA	loc16	n+1	16	MPYA	P, T, loc16	n+1	16
MPYS	loc16	n+1	16	MPYS	P, T, loc16	n+1	16
MPYU	loc16	n+1	16	MPYU	P, T, loc16	1	16
NEG		n+1	16	NEG	ACC	1	16
<b>NMI</b>		<b>4</b>	<b>16</b>	<b>Not applicable</b>			
NOP		n+1	16	NOP		n+1	16
NORM	*/+/*-/*0+/*0-	n+1	16	NORM	ACC, */+/*-/*0+/*0-	n+4	16
<b>NORM</b>	<b>*BR0+/*BR0-</b>	<b>n+1</b>	<b>16</b>	<b>Not applicable</b>			
OR	loc16	n+1	16	OR	ACC, loc16	n+1	16
OR	#16bit, 16	2	32	OR	ACC, #16bit<<16	1	32
OR	#16bit[, 0..15]	2	32	OR	ACC, #16bit {<< 0..15}	1	32
OUT	loc16, PA	3 (n+1)	32	OUT	* (PA), loc16	4	32
PAC		n+1	16	MOV	ACC, P<<PM	1	16
POP		n+1	16	MOVU	ACC, *--SP	1	16
POPD	loc16	n+1	16	POP	loc16	2	16
PSHD	loc16	n+1	16	PUSH	loc16	2	16
PUSH		n+1	16	MOV	*SP++, AL	n+1	16

† True/False

Table D-2. C2xLP Instructions and C28x Equivalent Instructions (Continued)

C2xLP				C28x			
Instruction	Mnemonic	Cycles	Size	Instruction	Mnemonic	Cycles	Size
RET		4	16	XRETC	UNC	7	16
RETC	COND	4/2 <sup>†</sup>		XRETC	COND	7/4	16
RETC	COND1, COND2, . . . , CONDn	4/2	16	SB	\$10, opposite of COND1	7+	48+
				SB	\$10, opposite of COND2		
				XRETC	CONDn		
				\$10:			
ROL		n+1	16	ROL	ACC	n+1	16
ROR		n+1	16	ROR	ACC	n+1	16
RPT	loc16	1	16	RPT	loc16	1	16
RPT	#8bit	1	16	RPT	#8bit	1	16
SACH	loc16[, 0]	n+1	16	MOV	loc16, AH	n+1	16
SACH	loc16, 1	n+1	16	MOVH	loc16, ACC << 1	n+1	16
SACH	loc16, 2..7	n+1	16	MOVH	loc16, ACC << 2..7	n+1	32
SACL	loc16[, 0]	n+1	16	MOV	loc16, AL	n+1	16
SACL	loc16, 1	n+1	16	MOV	loc16, ACC << 1	n+1	16
SACL	loc16, 2..7	n+1	16	MOV	loc16, ACC << 2..7	n+1	32
SAR	ARn, loc16	n+1	16	MOV	loc16, ARn	1	16
SBRK	#8bit	1	16	SBRK	#8bit	1	16
SETC	INTM	n+1	16	SETC	INTM	2	16
SETC	XF/OVM/SXM/TC/C	n+1	16	SETC	XF/OVM/SXM/TC/C	2, 1	16
<b>SETC</b>	<b>CNF</b>	<b>n+1</b>	<b>16</b>	<b>Not applicable</b>			
SFL		n+1	16	LSL	ACC, 1	n+1	16
SFR		n+1	16	SFR	ACC, 1	n+1	16
SPAC		n+1	16	SUB	ACC, P<<PM	n+1	16
SPH	loc16	n+1	16	MOVH	loc16, P	n+1	16
SPL	loc16	n+1	16	MOV	loc16, P	n+1	16

† True/False



Table D–2. C2xLP Instructions and C28x Equivalent Instructions (Continued)

C2xLP				C28x			
Instruc- tion	Mnemonic	Cycles	Size	Instruc- tion	Mnemonic	Cycles	Size
SPLK	#0x0000, loc16	2	32	MOV	loc16, #0	n+1	16
SPLK	#16bit, loc16	2	32	MOV	loc16, #16bit	n+1	32
SPM	0	1	16	SPM	0	1	16
SPM	1	1	16	SPM	1 (or +1)	1	16
SPM	2	1	16	SPM	2 (or +4)	1	16
SPM	3	1	16	SPM	3 (or -6)	1	16
SQRA	loc16	n+1	16	SQRA	loc16	n+1	32
SQRS	loc16	n+1	16	SQRS	loc16	n+1	32
<b>SST</b>	<b>#0/1, loc16</b>	<b>n+1</b>	<b>16</b>	<b>Not applicable</b>			
SUB	loc16[, 0]	n+1	16	SUB	ACC, loc16 {<< 0}	n+1	16
SUB	loc16, 1..15	n+1	16	SUB	ACC, loc16 << 1..15	n+1	32
SUB	loc16, 16	n+1	16	SUB	ACC, loc16 << 16	n+1	16
SUB	#8bit	1	16	SUBB	ACC, #8bit	1	16
SUB	#16bit[, 0..15]	2	32	SUB	ACC, #16bit {<< 0..15}	1	32
SUBB	loc16	n+1	16	SUBU	ACC, loc16	1	16
SUBC	loc16	n+1	16	SUBCU	ACC, loc16	n+1	16
SUBS	loc16	n+1	16	SUBU	ACC, loc16	n+1	16
SUBT	loc16	n+1	16	SUB	ACC, loc16 << T	n+1	32
TBLR	loc16	n+3	16	XPREAD	loc16, *AL	n+4	32
TBLW	loc16	n+3	16	XPWRITE	*AL, loc16	n+4	32
<b>TRAP</b>		<b>4</b>	<b>16</b>	<b>Not applicable</b>			
XOR	loc16	n+1	16	XOR	ACC, loc16	n+1	16
XOR	#16bit, 16	2	32	XOR	ACC, #16bit<<16	1	32
XOR	#16bit[, 0..15]	2	32	XOR	ACC, #16bit [<< 0..15]	1	32
ZALR	loc16	n+1	16	ZALR	ACC, loc16	1	32

† True/False

### D.3 Repeatability Instructions

Not all of the repeatable instructions on the C2xLP are repeatable on the C28x. The ones that were not made repeatable do not make sense to repeat from a functionality standpoint. Also, some instructions that were not repeatable on the C2xLP are repeatable on the C28x.

Table D–3 shows which C2xLP operations are repeatable, and which ones are repeatable on the C28x.

Table D–3. Repeatability Instructions for the C2xLP and C28x

C2xLP Instruction	C2xLP Repeatability	C28x Repeatability
ABS	X	
ADD mem,shift1	X	X
ADDC mem	X	
ADDS mem	X	X
ADDT mem	X	X
AND mem	X	X
APAC	X	X
BIT mem,bit_code	X	
BITT mem	X	
BLDD #addr,mem	X	X
BLDD mem,#addr	X	X
BLPD #pma,mem	X	X
CLRC CNF/XF/INTM/OVM/SXM/TC/C	X	
CMPL	X	
CMPR constant	X	
DMOV mem	X	X
IN mem,PA	X	X
INTR K	X	
LACC mem[,shift1]	X	
LACL mem	X	

Table D-3. Repeatable Instructions for the C2xLP and C28x (Continued)

C2xLP Instruction	C2xLP Repeatable	C28x Repeatable
LACT mem	X	
LAR AR,mem	X	
LDP mem	X	
LPH mem	X	
LST #n,mem	X	
LT mem	X	
LTA mem	X	X
LTD mem	X	
LTP mem	X	
LTS mem	X	X
MAC pma,mem	X	X
MACD pma,mem	X	X
MAR {ind],[nextARP]	X	X
MPY mem	X	
MPY #k	X	
MPYA mem	X	X
MPYS mem	X	X
MPYU mem	X	
NEG	X	
NOP	X	X
NORM {ind}	X	X
OR mem	X	X
OUT mem,PA	X	X
PAC	X	
POP	X	
POPD mem	X	

Table D–3. Repeatable Instructions for the C2xLP and C28x (Continued)

C2xLP Instruction	C2xLP Repeatable	C28x Repeatable
PSHD mem	X	
PUSH	X	
ROL	X	X
ROR	X	X
SACH mem[,shift]	X	X
SACL mem[,shift]	X	X
SAR AR,mem	X	
SETC CNF/XF/INTM/OVM/SXM/TC/C	X	
SFL	X	X
SFR	X	X
SPAC	X	X
SPH mem	X	X
SPL mem	X	X
SPLK #lk,mem	X	X
SQRA mem	X	X
SQRS mem	X	X
SST #n,mem	X	
SUB mem[,shift1]	X	X
SUBB mem	X	
SUBC mem	X	X
SUBS mem	X	X
SUBT mem	X	X
TBLR mem	X	X
TBLW mem	X	X
XOR mem	X	X
ZALR mem	X	

*Repeatable Instructions*

---

# Migration From C27x to C28x

---

---

---

This appendix highlights the architecture differences between the C27x and the C28x and describes how to migrate your code from a C27x-based design to a C28x-based design.

<b>Topic</b>	<b>Page</b>
<b>E.1 Architecture Changes .....</b>	<b>E-2</b>
<b>E.2 Moving to C28x Object .....</b>	<b>E-9</b>
<b>E.3 Migrating to C28x Object Code .....</b>	<b>E-11</b>
<b>E.4 Compiling C28x Source Code .....</b>	<b>E-16</b>

## E.1 Architecture Changes

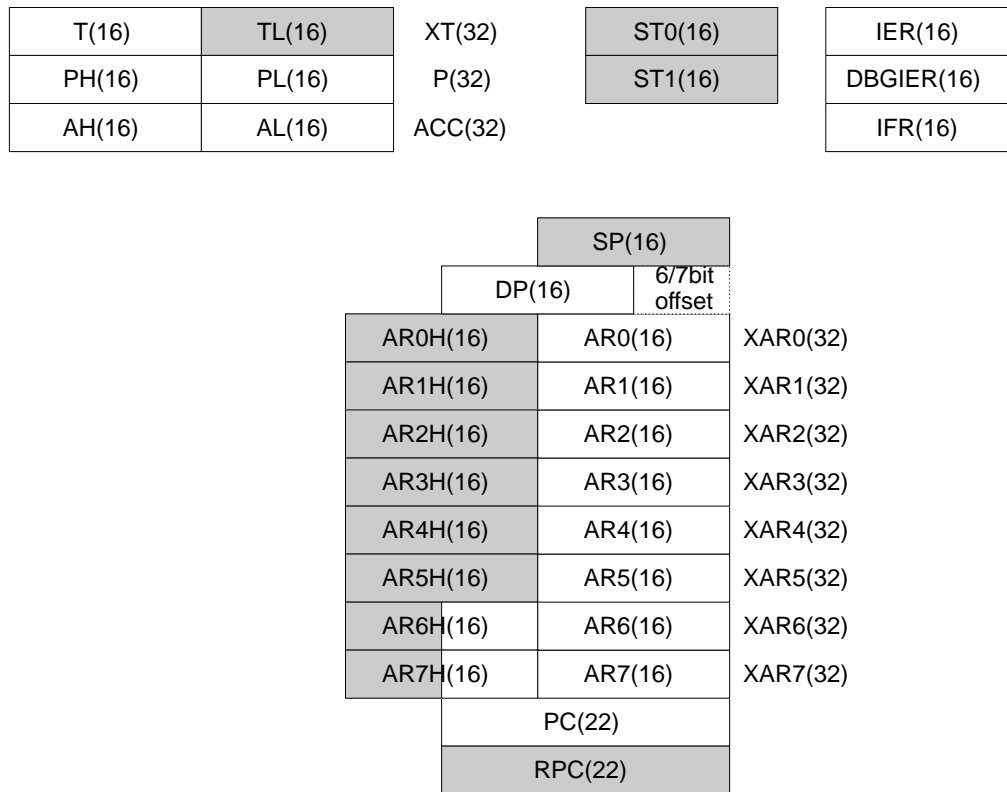
Certain changes to the architecture that are important when migrating from the C27x to the C28x include:

- Changes to registers
- Full context save and restore
- B0/B1 memory map consideration

### E.1.1 Changes to Registers

The register modifications from the C27x are shown in Figure E–1. Shaded registers highlight the changes or enhancements for the C28x.

Figure E–1. C28x Registers



A brief description of the register modifications is given below:

XT(32), TL(16):	The T register is increased to 32-bits and called the XT register. The existing C27x T register portion represents the upper 16-bits of the new 32-bit register. The additional 16-bits, called the TL portion, represents the lower 16-bits.
XAR0,...,XAR7(32):	All of the AR registers are stretched to 32-bits. This enables a full 22-bit address. For addressing operations, only the lower 22-bits of the registers are used, the upper 10-bits are ignored. For operations between the ACC, all 32-bits are valid (register addressing mode @XARx). For 16-bit operations to the low 16-bit of the registers (register addressing mode @ARx), the upper 16-bits are ignored.
RPC(22):	This is the return PC register. When a call operation is performed, the return address is saved in the RPC register and the old value in the RPC is saved on the stack (in two 16-bit operations). When a return operation is performed, the return address is read from the RPC register and the value on the stack is written into the RPC register (in two 16-bit operations). The net result is that return operations are faster (4 instead of 8 cycles)
SP(16):	By default the C28x SP register is initialized to 0x400 after a reset.
ST0 (16):	Shaded items indicate a change or addition from the C27x

*Table E-1. ST0 Register Bits*

Bit(s)	Mnemonic	Description	Reset Value	R/W
0	SXM	Sign Extension Mode Bit	0	R/W
1	OVM	Overflow Mode Bit	0	R/W
2	TC	Test Control Bit	0	R/W
3	C	Carry Bit	0	R/W
4	Z	Zero Condition Bit	0	R/W
5	N	Negative Condition Bit	0	R/W
6	V	Overflow Condition Bit	0	R/W
9:7	PM	Product Shift Mode	0 (+1 shift)	R/W
15:10	OVC/OVCU	ACC Overflow Counter	0	R/W

PM:	Functionality of the Product Shift Mode changes if the AMODE bit in ST1 is set to 1. C27x users will not modify the AMODE bit and PM will function as they did on the C27x.
OVC/OVCU:	The overflow counter is modified so that it behaves differently for signed or unsigned operations. For signed operations (OVC), it behaves as it does on the C27x (increment for positive overflow, decrement for negative underflow of a signed number). For unsigned operations (OVCU), the overflow counter increments for an ADD operation when there is a carry generated and decrements for a SUB operation when a borrow is generated. Basically, in unsigned mode, the OVCU behaves like a carry (C) counter and in signed mode the OVC behaves like an overflow (V) counter.



Table E-2. ST1 Register Bits

Bit(s)	Syntax	Description	Reset Value	R/W
0	INTM	Interrupt Enable Mask Bit	1 (disabled)	R/W
1	DBGM	DeBug Enable Mask Bit	1 (disabled)	R/W
2	PAGE0	PAGE0 Direct/Stack Address Mode	0	R/W
3	VMAP	Vector Map Bit	VMAP input	R/W
4	SPA	Stack Pointer Align Bit	0	R/W
5	LOOP	Loop Instruction Status Bit	0	R
6	EALLOW	Emulation Access Enable Bit	0	R/W
7	IDLESTAT	IDLE Status Flag Bit	0	R
8	AMODE	Address Mode Bit	0	R/W
9	OBJMODE	Object Compatibility Mode Bit	0	R/W
10	RESERVED	Reserved for future use	0	R
11	M0M1MAP	M0 and M1 Mapping Mode Bit	1	R
12	XF	XF Status Bit	0	R/W
15:13	ARP	Auxiliary Register Pointer	0	R/W

**AMODE:** This mode selects the appropriate addressing mode decodes for compatibility with the C2xLP device. For all C27x/C28x based projects leave this bit as 0.

**OBJMODE:** This mode is used to select between C27x object mode (OBJMODE == 0) and C28x object mode (OBJMODE == 1) compatibility. This bit is set by the "C28OBJ" (or "SETC OBJMODE") instructions. This bit is cleared by the "C27OBJ" (or "CLRC OBJMODE") instructions. The pipeline is flushed when setting or clearing this bit using the given instructions. This bit can be saved and restored by interrupts and when restoring the ST1 register. This bit is set to 0 on reset.

**M0M1MAP:** This mode is used to remap block M0 and M1 in program memory space as discussed in detail in section E.1.2. This bit is set by the "C28MAP" (or "SETC M0M1MAP") instructions. This bit is cleared by the "C27MAP" (or "CLRC M0M1MAP") instructions. The pipeline is flushed when setting or clearing this bit using the given instructions. This bit cannot be restored by interrupts and when restoring the ST1 register (read only).

**XF:** This bit reflects the current state of the XFS output signal. This signal is for C2xLP compatibility and is not used by C27x users.

## E.1.2 Full Context Save and Restore

On both C27x and C28x, the registers in Figure E–2 are automatically saved on the stack on an interrupt or trap operation and automatically restored on an IRET instruction.

Figure E–2. Full Context Save/Restore

31	16	1	0
T			ST0
AH			AL
PH			PL
AR1			AR0
DP			ST1
DBGSTAT			IER
PCH			PCL

Due to the register changes described in section E.1.1, C28x additional registers must be saved for a full-context store. Figure E–3 shows the difference between a C27x and C28x full-context save/restore for an interrupt or trap.

Figure E-3. Code for a Full Context Save/Restore for C28x vs C27x

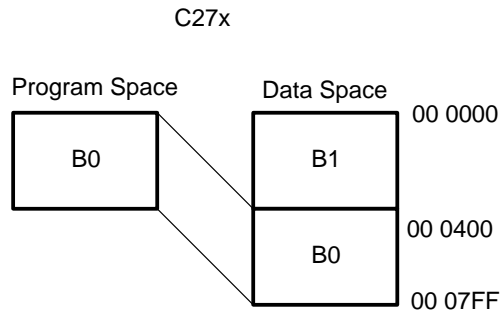
C27X Full Context Save/Rest	C28x Full Context Save/Restore
<pre> ----- IntX:  ; 8 cycles push  AR3:AR2       push          AR5:AR4       push          XAR6       push  XAR7       ; + 4 = 12 cycles       .       .       .       pop   XAR7       pop   XAR6       pop   AR5:AR4       pop   AR3:AR2       iret       ; 12 cycles </pre>	<pre> ----- IntX:  ; 8 cycles       PUSH  AR1H:AR0H  ; 32-bit       PUSH          XAR2  ; 32-bit       PUSH          XAR3  ; 32-bit       PUSH          XAR4  ; 32-bit       PUSH          XAR5  ; 32-bit       PUSH          XAR6  ; 32-bit       PUSH          XAR7  ; 32-bit       PUSH          XT    ; 32-bit       ; + 8 = 16 cycles       .       .       .       POP           XT       POP           XAR7       POP           XAR6       POP           XAR5       POP           XAR4       POP           XAR3       POP           XAR2       POP           AR1H:AR0H       IRET       ; 16 cycles </pre>

If you perform a task-switch operation (stack changes), the RPC register must be manually saved. You are not to save the RPC register if the stack is not changed.

### E.1.3 B0/B1 Memory Map Consideration

Another architecture change to consider is the C27x mapping of blocks B0 and B1. To avoid confusion, on the C28x these blocks are known as M1 and M0 respectively. On the C27x, block B1 was mapped to only data space and block B0 was mapped both in program and data space. In addition, block B0 was mapped to different address ranges in program and in data space. The C27x mapping of these blocks is shown in Figure E-4.

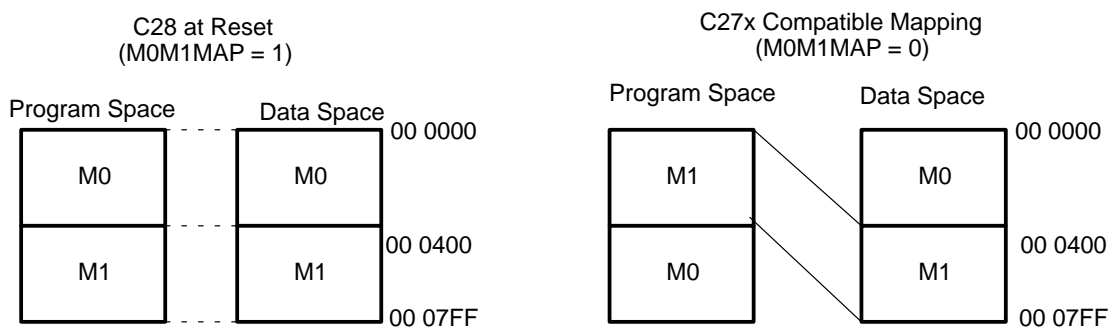
Figure E-4. Mapping of Memory Blocks B0 and B1 on C27x



On a C28x device at reset, these blocks are mapped uniformly in both program and data space as shown in Figure E-5. This can cause issues when running C27x object code that relies on the C27x mapping. If your code relies on this mapping, you can flip-block M0 and M1 in program space only by clearing the M0M1MAP bit in status register 1 (ST1) to a 0. Executing the "C27MAP" (or "CLRC M0M1MAP") instruction is the only way to clear this bit. With M0M1MAP == 0, the mapping is compatible with the C27x B0 and B1 blocks as shown in Figure D-4. Remember that after a reset M0 and M1 revert to the C28x mapping.

It is strongly recommended that you migrate your code to use the default C28x mapping of these blocks and not rely on the compatible mapping.

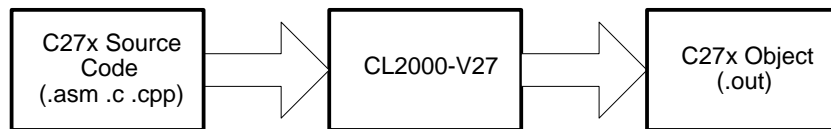
Figure E-5. C27x Compatible Mapping of Blocks M0 and M1



### E.1.4 C27x Object Compatibility

At reset, the C28x operates in C27x object mode (OBJMODE == 0). In this mode, the C28x CPU is 100% object-code compatible and cycle-count compatible with the C27x. In this case, you will compile your code just as you would for a C27x design as shown in Figure E-6.

Figure E-6. Building a C27x Object File From C27x Source



-v27

Accepts C27x syntax only. Generates C27x object only (assumes OBJMODE = 0)

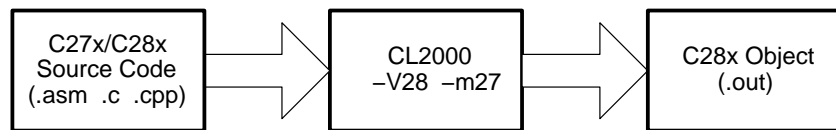
Once you have taken the mapping of blocks M0 and M1 into account as previously described, you can simply load the C27x object (.out) code into the C28x and run it. When using the C27x compatible mode, you are limited to the C27x instruction set. To take advantage of advanced C28x operations, you should migrate to C28x object code.

When the device is operating in C27x object mode (OBJMODE == 0), the upper bits of the stretched registers (XAR0(31:16) to XAR5(31:16), XAR6(31:22), XAR7(31:22)) are protected from writes. Hence, if the registers are set to zero by a reset then the XARn pointers behave like they do on the C27x and overflow problems are not of concern.

## E.2 Moving to a C28x Object

The C28x instruction set is a superset of the C27x instruction set. The syntax of a number of instructions however has changed slightly due to the modifications in registers as previously described. (For a summary of syntax changes, see Section E.3.1 *Instruction Syntax Changes*). To quickly move to C28x object code, the codegen tools allow you to build a C28x object file with a switch allowing for C27x source syntax:

Figure E-7. Building a C28x Object File From Mixed C27x/C28x Source



-v28-m27

Accepts C28x & C27x syntax. Generates C28x object only (assumes OBJMODE == 1)

Prior to running C28x object you must set the mode of the device appropriately (OBJMODE == 1). To do this, you set the OBJMODE bit in ST1 to 1 after reset. This can be done with a "C28OBJ" (or "SETC OBJMODE") instruction. Note that before the "C28OBJ" instruction is executed, the disassembly window in the debugger may display incorrect information. This is because the debugger will decode memory as C27x opcodes until after you execute the "C28OBJ" instruction.

When running in this mode, the disassembly window in your debugger will show the C28x instruction syntax for all instructions. For example, the C27x MOV AR0,@SP instruction will look like MOVZ AR0,@SP, which is the C28x-equivalent instruction.

Now that you are using a C28x object file, you can add C28x operations to your source code.

### E.2.1 Caution When Changing OBJMODE

On reset, the XARn registers are forced to 0x0000 0000 and OBJMODE == 0. When operating in C27x compatible mode (OBJMODE == 0), the upper bits of the XARn registers are protected from writes. Some things to be aware of when changing OBJMODE:

- When operating in C28x object mode (OBJMODE == 1) overflow can occur to the extended portion of XARn registers and program execution is not specified. This would be an issue for assembly code that is reassembled in C28x mode when you relied on the fact that C27x registers were a certain size.
- If the user switches to C28x object mode (OBJMODE == 1), then the upper bits of XARn registers may be modified. If you then switch back to C27x

mode (OBJMODE == 0), the upper bits of XARn registers may contain nonzero values. You MUST zero out the upper bits of the XARn registers when switching from OBJMODE == 1 to OBJMODE == 0.

- It is recommended that you not switch modes frequently in your code. Typically, you will select the appropriate operating mode at boot time and stick to one mode for the whole program.

## **E.3 Migrating to C28x Object Code**

This section describes additional changes to C27x necessary for migrating your C27x code to pure C28x code.

### **E.3.1 Instruction Syntax Changes**

Syntax changes were necessary for clarity and because of changes in the auxiliary registers stretched pointers. Table E-3 shows the C27x instructions that changed syntax on the C28x. For all other C27x instructions, the syntax remains the same. For new C28x instructions, the syntax is documented in Chapter 6.



Table E-3. Instruction Syntax Change

C27x Syntax		C28x Syntax	
ADDB	ARn, #7bit	ADDB	XARn, #7bit
ADDB	XAR6/7, #7bit		
SUBB	ARn, #7bit	SUBB	XARn, #7bit
SUBB	XAR6/7, #7bit		
MOV	AR0/.. /5, loc16	MOVZ	AR0/.. /5, loc16
MOVB	AR0/.. /5, #8bit	MOVB	XAR0/.. /5, #8bit
MOV	XAR6/7, loc32	MOVL	XAR6/7, loc32
MOVL	XAR6/7, loc32		
MOV	XAR6/7, #22bit	MOVL	XAR6/7, #22bit
MOVL	XAR6/7, #22bit		
MOV	loc32, XAR6/7	MOVL	loc32, XAR6/7
MOVL	loc32, XAR6/7		
CALL	22bit	LC	22bit
LC	22bit		
CALL	*XAR7	LC	*XAR7
LC	*XAR7		
RET		LRET	
LRET			
RETE		LRETE	
LRETE			
MOV	ACC, P {MOVP T, @T decode}	MOVL	ACC, P << PM {MOVP T, @T decode}
ADD	ACC, P {MOVA T, @T decode}	ADDL	ACC, P << PM {MOVA T, @T decode}
SUB	ACC, P {MOVS T, @T decode}	SUBL	ACC, P << PM {MOVS T, @T decode}
CMP	ACC, P	CMPL	ACC, P << PM
MOV	P, ACC	MOVL	P, ACC
NORM	ACC, ARn++	NORM	ACC, XARn++
NORM	ACC, XAR6/7++		
NORM	ACC, ARn--	NORM	ACC, XARn--
NORM	ACC, XAR6/7--		
B	16bitOff {unconditional}	B	16bitOff, UNC [2]
SB	8bitOff {unconditional}	SB	8bitOff, UNC [2]

For conditional branches on the C28x, the UNC code must always be specified for unconditional tests. This will help to distinguish between unconditional C2xLP branches (which have the same mnemonic "B").

### E.3.2 Repeatable Instructions

On the C28x, additional instructions have been made repeatable. The following two tables list those instructions that are repeatable on the C28x device. These instructions are repeatable in both C27x compatible mode (OBJMODE = 0) and C28x native mode (OBJMODE = 1). Any instruction that is not listed, which follows a repeat instruction, will execute only once.

C27x operations that were already repeatable include the following:

ROR	ACC
ROL	ACC
NORM	ACC,XARn++
NORM	ACC,XARn--
SUBCU	ACC,loc16
MAC	P,loc16,0:pma
MOV	*(0:addr),loc16
MOV	loc16,*(0:addr)
MOV	loc16,#16bit
MOV	loc16,#0
PREAD	loc16,*XAR7
PWRITE	*XAR7,loc16
NOP	loc16

C27x Operations That Are Made Repeatable On C28x include the following:

MOV	loc16,AX
ADD	ACC,loc16 << 16
ADDU	ACC,loc16
SUB	ACC,loc16 << 16
SUBU	ACC,loc16
ADDL	ACC,loc32
SFR	ACC,1..16
LSL	ACC,1..16
MOVH	loc16,P
MOV	loc16,P
MOVA	T,loc16
MOVS	T,loc16
MPYA	P,T,loc16
MPYS	P,T,loc16

### E.3.3 Changes to the SUBCU Instruction

The SUBCU instruction changed slightly from the C27x to the C28x. Under the prescribed usage of the SUBCU operation, the change will yield the same result as the C27x.

The SUBCU instruction operates as follows on the C27x device:

```
temp(31:0) = ACC - [loc16] << 15
if( temp32 >= 0 )
    ACC = temp(31:0) >> 1 + 1;
else
    ACC = ACC << 1;
```

To simplify the implementation, the SUBCU operation changed as follows on the C28x:

```
temp(32:0) = ACC << 1 - [loc16] << 16
if( temp(32:0) >= 0 )
    ACC = temp(31:0) + 1;
else
    ACC = ACC << 1;
```

- The "temp(32:0)" value is the result of an unsigned 33-bit compare. The carry bit is used to select between  $\geq$  or  $<$  condition.

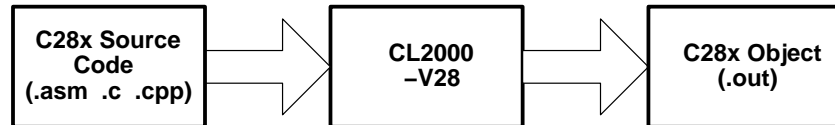
- ❑ The C flag is affected by the unsigned 33-bit compare operation. The Z, N flags reflect the value in the ACC after the operation is complete. The operation of the C, N, Z flags should be identical to the C27x implementation.
- ❑ The V flag and overflow counter (OVC) are not affected by the operation. On the C27x the V and OVC flags are affected.

The V and OVC flags may be affected on the C27x and not on the C28x implementation. The values of these flags are not usable under prescribed usage of such an operation.

## E.4 Compiling C28x Source Code

Once you move your code to C28x native instructions, you will no longer use the `-m27` switch to allow for C27x source as shown in Figure E-8.

Figure E-8. Compiling C28x Source



`-v28:` Accepts C28x syntax only. Generates C28x object only (assumes OBJMODE = 1)

# Revision History

## F.1 Changes

This revision history lists the technical changes made in the most recent revision.

*Table F–1. Revision History*

<b>Location</b>	<b>Additions, Deletions, Modifications</b>
Preface page iii	Changed About This Manual introduction and Chapter 1 description.
Preface page vii	Updated Related Documents From Texas Instruments.
Chapter 1	Changed introduction.
Table 2–6	Changed descriptions for MAX, MAXL, MIN, and MINL.
Page 2-32	Changed description of SXM bit values and added example code.
Example 3–1	Removed period in first line and changed semicolon to colon in 21st line.
Section 3.6	Added fourth bullet and fifth bullets.
Section 4.1.2	Changed DZ to D2.
Section 6.1, 6.2	Added note on cycle counts.
Page 6-78	Changed example for CMP64 ACC:P instruction.
Page 6-46	Changed 0xFFBE to 0xFFDE in example for AND IER, #16bit instruction.
Page 6-145	Changed RPT and CYC values for MAC P, loc16, 0:pma instruction.
Page 6-149	Changed then to than for MAX AX, loc16 instruction.
Page 6-150	Added closing square bracket in Description note and changed 2 to 0 in 7th line of example for MAXCUL P, loc32 instruction.
Page 6-152, 6-153, 6-154	Changed then to than for multiple instructions.

---

*Table F–1. Revision History*

<b>Location</b>	<b>Additions, Deletions, Modifications</b>
Page 6-168	Changed Repeat description for MOV loc16, ARn instruction.
Page 6-201	Changed operand from loc16 to loc32, modified Repeat description, and moved notes in example for MOVDL instruction.
Page 6-211	Changed T to XT in Description of MOVL loc32, XT instruction.
Page 6-224	Changed operand listed for Description from loc32 for MOVX TL, loc16 instruction.
Page 6-243	Changed PSA to SPA in Flags and Modes for NASP instruction.
Page 6-267	Changed OPCODE value for POP ACC instruction.
Page 6-313	Modified alignment of code in Description for SAT ACC instruction.
Page 6-326	Changed RPT and CYC values for SFR ACC, T instruction.
Page 6-327	Changed Repeat description for SPM shift instruction.
Page 6-337	Added else to N flag description for SUB ACC, #16bit << 0..15 instruction.
Page 6-341	Changed to in Description to from for SUBB SP, #7bit instruction.
Page 6-360	Changed ADD to XOR in 6th line of example for TBIT loc16, T instruction.
Page 6-363	Corrected grammar in Description and added SP = SP + 2; line in example for TRAP #VectorNumber instruction.
Table A–1	Added POP to Instructions for IFR register.
Appendix B–E	Removed original Appendix B, <i>Submitting Rom Codes to TI</i> , and renumbered remaining appendices.

---





# Glossary

---

---

---

## A

**16-bit operation:** An operation that reads or writes 16 bits.

**32-bit operation:** An operation that reads or writes 32 bits.

**absolute branch:** A branch to an address that is permanently assigned to a memory location. See also *offset branch*.

**ACC:** See *accumulator (ACC)*.

**access:** A term used in this document to mean *read from* or *write to*. For example, to access a register is to read from or write to that register.

**accumulator (ACC):** A 32-bit register involved in a majority of the arithmetic and logical calculations done by the C28x. Some instructions that affect ACC use all 32 bits of the register. Others use one of the following portions of ACC: AH (bits 31 through 16), AL (bits 15 through 0), AH.MSB (bits 31 through 24), AH.LSB (bits 23 through 16), AL.MSB (bits 15 through 8), and AL.LSB (bits 7 through 0).

**address-generation logic:** Hardware in the CPU that generates the addresses used to fetch instructions or data from memory.

**address reach:** The range of addresses beginning with  $00\ 0000_{16}$  that can be used by a particular addressing mode.

**address register arithmetic unit (ARAU):** Hardware in the CPU that generates addresses for values that must be fetched from data memory. The ARAU is also the hardware used to increment or decrement the stack pointer (SP) and the auxiliary registers (AR0, AR1, AR2, AR3, AR4, AR5, XAR6, and XAR7).

**addressing mode:** The method by which an instruction interprets its operands to acquire the data and/or addresses it needs.

**AH:** *High word of the accumulator.* The name given to bits 31 through 16 of the accumulator.

**AH.LSB:** *Least significant byte of AH.* The name given to bits 23 through 16 of the accumulator.

**AH.MSB:** *Most significant byte of AH.* The name given to bits 31 through 24 of the accumulator.

**AL:** *Low word of the accumulator.* The name given to bits 15 through 0 of the accumulator.

**AL.LSB:** *Least significant byte of AL.* The name given to bits 7 through 0 of the accumulator.

**AL.MSB:** *Most significant byte of AL.* The name given to bits 15 through 8 of the accumulator.

**ALU:** See *arithmetic logic unit (ALU)*.

**analysis logic:** A portion of the emulation logic in the core. The analysis logic is responsible for managing the following debug activities: hardware breakpoints, hardware watchpoints, data logging, and benchmark/event counting.

**approve an interrupt request:** Allow an interrupt to be serviced. If the interrupt is maskable, the CPU approves the request only if it is properly enabled. If the interrupt is nonmaskable, the CPU approves the request immediately. See also *interrupt request* and *service an interrupt*.

**ARAU:** See *address register arithmetic unit (ARAU)*.

**arithmetic logic unit (ALU):** A 32-bit hardware unit in the CPU that performs 2s-complement arithmetic and Boolean logic operations. The ALU accepts inputs from data from registers, from data memory, or from the program control logic. The ALU sends results to a register or to data memory.

**arithmetic shift:** A shift that treats the shifted value as signed. See also *logical shift*.

**ARP:** See *auxiliary register pointer (ARP)*.

**ARP indirect addressing mode:** The indirect addressing mode that uses the current auxiliary register to point to a location in data space. The current auxiliary register is the auxiliary register pointed to by the ARP. See also *auxiliary register pointer (ARP)*.

**automatic context save:** A save of system context (modes and key register values) performed by the CPU just prior to executing an interrupt service routine. See also *context save*.

**auxiliary register:** One of eight registers used as a pointer to a memory location. The register is operated on by the auxiliary register arithmetic unit (ARAU) and is selected by the auxiliary register pointer (ARP). See also *AR0–AR5*, *AR6/AR7*, and *XAR6/XAR7*.

**auxiliary-register indirect addressing mode:** The indirect addressing mode that allows you to use the name of an auxiliary register in an operand that uses that register as a pointer. See also *ARP indirect addressing mode*.

**auxiliary register pointer (ARP):** A 3-bit field in status register ST1 that selects the current auxiliary register. When an instruction uses ARP indirect addressing mode, that instruction uses the current auxiliary register to point to data space. When an instruction specifies auxiliary register *n* by using auxiliary-register indirect addressing mode, the ARP is updated, so that it points to auxiliary register *n*. See also *current auxiliary register*.

**B**

**background code:** The body of code that can be halted during debugging because it is not time-critical.

**barrel shifter:** Hardware in the CPU that performs all left and right shifts of register or data-space values.

**bit field:** One or more register bits that are differentiated from other bits in the same register by a specific name and function.

**bit manipulation:** The testing or modifying of individual bits in a register or data-space location.

**boundary scan:** The use of scan registers on the border of a chip or section of logic to capture the pin states. By scanning these registers, all pin states can be transmitted through the JTAG port for analysis.

**branch:** 1) A forcing of program control to a new address. 2) An instruction that forces program control to a new address but neither saves a return address (like a call) nor restores a return address (like a return).

**break event:** A debug event that causes the CPU to enter the debug-halt state.

**breakpoint:** A place in a routine specified by a breakpoint instruction or hardware breakpoint, where the execution of the routine is to be halted and the debug-halt state entered.

## C

**C bit:** See *carry (C) bit*.

**call:** 1) The operation of saving a return address and then forcing program control to a new address. 2) An instruction that performs such an operation. See also *return*.

**carry (C) bit:** A bit in status register ST0 that reflects whether an addition has generated a carry or a subtraction has generated a borrow.

**circular addressing mode:** The indirect addressing mode that can be used to implement a circular buffer.

**circular buffer:** A block of addresses referenced by a pointer using circular addressing mode, so that each time the pointer reaches the bottom of the block, the pointer is modified to point back to the top of the block.

**clear :** To clear a bit is to write a 0 to it. To clear a register or memory location is to load all its bits with 0s. See also *set*.

**COFF:** *Common object file format*. A binary object file format that promotes modular programming by supporting the concept of sections, where a section is a relocatable block of code or data that ultimately occupies a space adjacent to other blocks of code in the memory map.

**conditional branch instruction:** A branch instruction that may or may not cause a branch, depending on a specified or predefined condition (for example, the state of a bit).

**context restore:** A restoring of the previous state of a system (for example, modes and key register values) prior to returning from a subroutine. See also *context save*.

**context save:** A save of the current state of a system (for example, modes and key register values) prior to executing the main body of a subroutine that requires a different context. See also *context restore*.

**core:** The portion of the C28x that consists of a CPU, a block of emulation circuitry, and a set of signals for interfacing with memory and peripheral devices.

**current auxiliary register:** The register selected by the auxiliary register pointer (ARP) in status register. For example, if ARP = 3, the current auxiliary register is AR3. See also *auxiliary registers*.

**current data page:** The data page selected by the data page pointer. For example, if DP = 0, the current data page is 0. See also *data page*.

**D**

**D1 phase:** See *decode 1 (D1) phase*.

**D2 phase:** See *decode 2 (D2) phase*.

**data logging:** Transferring one or more packets of data from CPU registers or memory to an external host processor.

**data log interrupt (DLOGINT):** A maskable interrupt triggered by the on-chip emulation logic when a data logging transfer has been completed.

**data page:** A 64-word portion of the total 4M words of data space. Each data page has a specific start address and end address. See also *data page pointer (DP)* and *current data page*.

**data page pointer (DP):** A 16-bit pointer that identifies which 64-word data page is accessed in DP direct addressing mode. For example, for as long as DP = 500, instructions that use DP direct addressing mode will access data page 500.

**data-/program-write data bus (DWDB):** The bus that carries data during writes to data space or program space.

**data-read address bus (DRAB):** The bus that carries addresses for reads from data space.

**data-read data bus (DRDB):** The bus that carries data during reads from data space.

**data-write address bus (DWAB):** The bus that carries addresses for writes to data space.

**DBGIER:** See *debug interrupt enable register (DBGIER)*.

**DBGM bit:** See *debug enable mask (DBGM) bit*.

**DBGSTAT:** See *debug status register (DBGSTAT)*.

**debug-and-test direct memory access (DT-DMA):** An access of a register or memory location to provide visibility to this location during debugging. The access is performed with variable levels of intrusiveness by a hardware DT-DMA mechanism inside the core.

**debug enable mask (DBGM) bit:** A bit in status register ST1 used to enable (DBGM = 0) or disable (DBGM = 1) debug events such as analysis breakpoints or debug-and-test direct memory accesses (DT-DMAs).

**debug event:** An action such as the decoding of a software breakpoint instruction, the occurrence of an analysis breakpoint/watchpoint, or a request from a host processor that may result in special debug behavior, such as halting the device or pulsing one of the debug interface signals EMU0 or EMU1. See also *break event* and *debug enable mask (DBGM) bit*.

**debug-halt state:** A debug execution state that is entered through a break event. In this state the CPU is halted. See also *single-instruction state* and *run state*.

**debug host:** See *host processor*.

**debug interrupt enable register (DBGIER):** The register that determines which of the maskable interrupts are time-critical when the CPU is halted in real-time mode. If a bit in the DBGIER is 1, the corresponding interrupt is time-critical/enabled; otherwise, it is disabled. Time-critical interrupts also must be enabled in the interrupt enable register (IER) to be serviced.

**debug status register (DBGSTAT):** A register that holds special debug status information. This register, which need not be read from or written to, is saved and restored during interrupt servicing, to preserve the debug context during debugging.

**decode an instruction:** To identify an instruction and prepare the CPU to perform the operation the instruction requires.

**decode 1 (D1) phase:** The third of eight pipeline phases an instruction passes through. In this phase, the CPU identifies instruction boundaries in the instruction-fetch queue and determines whether the next instruction to be executed is an illegal instruction. See also *pipeline phases*.

**decode 2 (D2) phase:** The fourth of eight pipeline phases an instruction passes through. In this phase, the CPU accepts an instruction from the instruction-fetch queue and completes the decoding of that instruction, performing such activities as address generation and pointer modification. See also *pipeline phases*.

**decrement:** To subtract 1 or 2 from a register or memory value. The value subtracted depends on the circumstance. For example, if you use the operand \*--AR4, the auxiliary register AR4 is decremented by 1 for a 16-bit operation and by 2 for a 32-bit operation.

**device reset:** See *reset*.

**direct addressing modes:** The addressing modes that access data space as if it were 65 536 separate blocks of 64 words each. DP direct addressing mode uses the data page pointer (DP) to select a data page from 0 to 65 535. PAGE0 direct addressing mode uses data page 0, regardless of the value in the DP.

**discontinuity:** See *program-flow discontinuity*.

**DLOGINT:** See *data log interrupt (DLOGINT)*.

**DP:** See *data page pointer (DP)*.

**DP direct addressing mode:** A direct addressing mode that uses the data page pointer (DP) to select a data page from 0 to 65 535. See also *PAGE0 direct addressing mode*.

**DRAB:** See *data-read address bus (DRAB)*.

**DRDB:** See *data-read data bus (DRDB)*.

**DT-DMA:** See *debug-and-test direct memory access (DT-DMA)*.

**DWAB:** See *data-write address bus (DWAB)*.

**DWDB:** See *data-/program-write data bus (DWDB)*.

## E

**E phase:** See *execute (E) phase*.

**EALLOW bit:** See *emulation access enable (EALLOW) bit*.

**EMU0 and EMU1 pins:** Pins known as the TI extensions to the JTAG interface. These pins can be used as either inputs or outputs and are available to help monitor and control an emulation target system that is using a JTAG interface.

**emulation access enable (EALLOW) bit:** A bit in status register ST1 that enables (EALLOW = 1) or disables (EALLOW = 0) access to the emulation registers. The EALLOW instruction sets the EALLOW bit, and the EDIS instruction clears the EALLOW bit.

**emulation logic:** The block of hardware in the core that is responsible controlling emulation activities such as data logging and switching among debug execution states.

**emulation registers:** Memory-mapped registers that are available for controlling and monitoring emulation activities.

**enable bit:** See *interrupt enable bits*.

**execute an instruction:** Take an instruction from the decode 2 phase of the pipeline through the write phase of the pipeline.

**execute (E) phase:** The seventh of eight pipeline phases an instruction passes through. In this phase, the CPU performs all multiplier, shifter, and arithmetic-logic-unit (ALU) operations. See also *pipeline phases*.

**extended auxiliary registers:** See *XAR6/XAR7*.

## F

**F1 phase:** See *fetch 1 (F1) phase*.

**F2 phase:** See *fetch 2 (F2) phase*.

**FC :** See *fetch counter (FC)*.

**fetch 1 (F1) phase:** The first of eight pipeline phases an instruction passes through. In this phase, the CPU places on the program-read bus the address of the instruction(s) to be fetched. See also *pipeline phases*.

**fetch 2 (F2) phase:** The second of eight pipeline phases an instruction passes through. In this phase, the CPU fetches an instruction or instructions from program memory. See also *pipeline phases*.

**fetch counter (FC) :** The register that contains the address of the instruction that is being fetched from program memory.

**field :** See *bit field*.

## H

**hardware interrupt:** An interrupt initiated by a physical signal (for example, from a pin or from the emulation logic). See also *software interrupt*.

**hardware interrupt priority:** A priority ranking used by the CPU to determine the order in which simultaneously occurring hardware interrupts are serviced.

**hardware reset:** See *reset*.

**high addresses:** Addresses closer to  $3F\ FFFF_{16}$  than to  $00\ 0000_{16}$ . See also *low addresses*.

**high bits:** See *MSB*.



**high word:** The 16 MSBs of a 32-bit value. See also *low word*.

**host processor:** The processor running the user interface for a debugger.

**I**

**IC:** See *instruction counter (IC)*.

**IDLESTAT (IDLE status) bit:** A bit in status register ST1 that indicates when an IDLE instruction has the CPU in the idle state (IDLESTAT = 1).

**idle state:** The low-power state the CPU enters when it executes the IDLE instruction.

**IEEE 1149.1 standard:** “IEEE Standard Test Access Port and Boundary-Scan Architecture”, first released in 1990. See also *JTAG*.

**IER:** See *interrupt enable register (IER)*.

**IFR:** See *interrupt flag register (IFR)*.

**illegal instruction:** An unacceptable value read from program memory during an instruction fetch. Unacceptable values are  $0000_{16}$ ,  $FFFF_{16}$ , or any value that does not match a defined opcode.

**illegal-instruction trap:** A trap that is serviced when an illegal instruction is decoded.

**immediate address:** An address that is specified directly in an instruction as a constant.

**immediate addressing modes:** Addressing modes that accept a constant as an operand.

**immediate constant/data:** A constant specified directly as an operand of an instruction.

**immediate-constant addressing mode:** An immediate addressing mode that accepts a constant as an operand and interprets that constant as data to be stored or processed.

**immediate-pointer addressing mode:** An immediate addressing mode that accepts a constant as an operand and interprets that constant as the 16 LSBs of a 22-bit address. The six MSBs of the address are filled with 0s.

**increment:** To add 1 or 2 to a register or memory value. The value added depends on the circumstance. For example, if you use the operand *\*AR4++*, the auxiliary register AR4 is incremented by 1 for a 16-bit operation and by 2 for a 32-bit operation.

**indirect addressing modes:** Addressing modes that use pointers to access memory. The available pointers are auxiliary registers AR0–AR5, extended auxiliary registers XAR6 and XAR7, and the stack pointer (SP).

**instruction boundary:** The point where the CPU has finished one instruction and is considering what it will do next — move on to the next instruction.

**instruction counter (IC):** The register that points to the instruction in the decode 1 phase (the instruction that is to enter the decode 2 phase next). Also, on an interrupt or call operation, the IC value represents the return address, which is saved to the stack or to auxiliary register XAR7.

**instruction-fetch mechanism:** The hardware for the fetch 1 and fetch 2 phases of the pipeline. This hardware is responsible for fetching instructions from program memory and filling an instruction-fetch queue.

**instruction-fetch queue:** A queue of four 32-bit registers that receives fetched instructions and holds them for decoding. When a program-flow discontinuity occurs, the instruction-fetch queue is emptied.

**instruction-not-available condition:** The condition that occurs when the decode 2 pipeline hardware requests an instruction but there are no instructions waiting in the instruction-fetch queue. This condition causes the decode 2 through write phases of the pipeline to freeze until one or more new instructions have been fetched.

**instruction register:** The register that contains the instruction that has reached the decode 2 pipeline phase.

**instruction word:** Either an entire 16-bit opcode or one of the halves of a 32-bit opcode.

**INT1–INT14:** Fourteen general-purpose interrupts that are triggered by signals at pins of the same names. These interrupts are maskable and have corresponding bits in the interrupt flag register (IFR), the interrupt enable register (IER), and the debug interrupt enable register (DBGIER).

**Interrupt boundary:** An instruction boundary where the CPU can insert an interrupt between two instructions. See also *instruction boundary*.

**interrupt enable bits:** Bits responsible for enabling or disabling maskable interrupts. The enable bits are all the bits in the interrupt enable register (IER), all the bits in the debug interrupt enable register (DBGIER), and the interrupt global mask bit (INTM in status register ST1).

**interrupt enable register (IER):** Each of the maskable interrupts has an interrupt enable bit in this register. If a bit in the IER is 1, the corresponding interrupt is enabled; otherwise, it is disabled. See also *debug interrupt enable register (DBGIER)*.

**interrupt flag bit:** A bit in the interrupt flag register (IFR). If the interrupt flag bit is 1, the corresponding interrupt has been requested by hardware and is awaiting approval by the CPU.

**interrupt flag register (IFR):** The register that contains the interrupt flag bits for the maskable interrupts. If a bit in the IFR is 1, the corresponding interrupt has been requested by hardware and is awaiting approval by the CPU.

**interrupt global mask (INTM) bit:** A bit in status register ST1 that globally enables or disables the maskable interrupts. If an interrupt is enabled in the interrupt enable register (IER) but not by the INTM bit, it is not serviced. The only time this bit is ignored is when the CPU is in real-time mode and is in the debug-halt state; in this situation, the interrupt must be enabled in the IER and in the DBGIER (debug interrupt enable register).

**interrupt priority:** See *hardware interrupt priority*.

**interrupt request:** A signal or instruction that requests the CPU to execute a particular interrupt service routine. See also *approve an interrupt request* and *service an interrupt*.

**interrupt service routine (ISR):** A subroutine that is linked to a specific interrupt by way of an interrupt vector.

**interrupt vector:** The start address of an interrupt service routine. After approving an interrupt request, the CPU fetches the interrupt vector from your interrupt vector table and uses the vector to branch to the start of the corresponding interrupt service routine.

**interrupt vector location:** The preset location in program memory where an interrupt vector must reside.

**interrupt vector table:** The list of interrupt vectors you assign in program memory.

**INTM bit:** See *interrupt global mask (INTM) bit*.

**ISR:** See *interrupt service routine (ISR)*.

## J

**JTAG:** *Joint Test Action Group.* The Joint Test Action Group was formed in 1985 to develop economical test methodologies for systems designed around complex integrated circuits and assembled with surface-mount technologies. The group drafted a standard that was subsequently adopted by IEEE as IEEE Standard 1149.1-1990, "IEEE Standard Test Access Port and Boundary-Scan Architecture". See also *boundary scan*; *test access port (TAP)*.

**JTAG port:** See *test access port (TAP)*.

## L

**latch:** Hold a bit at the same value until a given event occurs. For example, when an overflow occurs in the accumulator, the V bit is set and latched at 1 until it is cleared by a conditional branch instruction or by a write to status register ST0. An interrupt is latched when its flag bit has been latched in the interrupt flag register (IFR).

**least significant bit (LSB):** The bit in the lowest position of a binary number. For example, the LSB of a 16-bit register value is bit 0. See also *MSB*, *LSByte*, and *MSByte*.

**least significant byte (LSByte):** The byte in the lowest position of a binary value. The LSByte of a value consists of the eight LSBs. See also *MSByte*, *LSB*, and *MSB*.

**location:** A space where data can reside. A location may be a CPU register or a space in memory.

**logical shift:** A shift that treats the shifted value as unsigned. See also *arithmetic shift*.

**LOOP (loop instruction status) bit:** A bit in status register ST1 that indicates when a LOOPNZ or LOOPZ instruction is being executed (LOOP = 1).

**low addresses:** Addresses closer to 00 0000<sub>16</sub> than to 3F FFFF<sub>16</sub>. See also *high addresses*.

**low bits:** See *LSB*.

**low word:** The 16 LSBs of a 32-bit value. See also *high word*.

**LSB:** When used in a syntax of the MOV<sub>B</sub> instruction, LSB means least significant byte. Otherwise, LSB means least significant bit. See *least significant bit (LSB)* and *least significant byte (LSByte)*.

**LSByte:** See *least significant byte (LSByte)*.

**M**

**maskable interrupt:** An interrupt that can be disabled by software so that the CPU does not service it until it is enabled by software. See also *non-maskable interrupt*.

**memory interface:** The buses and signals responsible for carrying communications between the core and on-chip memory/peripherals.

**memory-mapped register:** A register that can be accessed at addresses in data space.

**memory wrapper:** The hardware around a memory block that identifies access requests and controls accesses for that memory block.

**mirror:** A range of addresses that is the same size and is mapped to the same physical memory block as another range of addresses.

**most significant bit (MSB):** The bit in the highest position of a binary number. For example, the MSB of a 16-bit register value is bit 15. See also *LSB*, *LSByte*, and *MSByte*.

**most significant byte (MSByte):** The byte in the highest position of a binary value. The MSByte of a value consists of the eight MSBs. See also *LSByte*, *LSB*, and *MSB*.

**MSB:** When used in a syntax of the MOV<sub>B</sub> instruction, MSB means most significant byte. Otherwise MSB means most significant bit. See *most significant bit (MSB)* and *most significant byte (MSByte)*.

**MSByte:** See *most significant byte (MSByte)*.

**multiplicand register (T):** The primary function of this register, also called the T register, is to hold one of the values to be multiplied during a multiplication. The following shift instructions use the four LSBs to hold the shift count: ASR (arithmetic shift right), LSL (logical shift left), LSR (logical shift right), and SFR (shift accumulator right). The T register can also be used as a general-purpose 16-bit register.

## N

**N (negative flag) bit:** A bit in status register ST0 that indicates whether the result of a calculation is a negative number ( $N = 1$ ). N is set to match the MSB of the result.

**nested interrupt:** An interrupt that occurs within an interrupt service routine.

**NMI:** A hardware interrupt that is nonmaskable, like reset ( $\overline{RS}$ ), but does not reset the CPU.  $\overline{NMI}$  simply forces the CPU to execute its interrupt service routine.

**nonmaskable interrupt:** An interrupt that cannot be blocked by software and is approved by the CPU immediately. See also *maskable interrupt*.

## O

**offset branch:** A branch that uses a specified or generated offset value to jump to an address relative to the current position of the program counter (PC). See also *absolute branch*.

**opcode:** This document uses opcode to mean the complete code for an instruction. Thus, an opcode includes the binary sequence for the instruction type and the binary sequence and/or constant in which the operands are encoded.

**operand :** This document uses operand to mean one of the values entered after the instruction mnemonic and separated by commas (or for a shift operand, separated by the symbol <<). For example, in the CLRC INTM instruction, CLRC is the mnemonic and INTM is the operand.

**operation:** 1) A defined action; namely, the act of obtaining a result from one or more operands in accordance with a rule that completely specifies the result of any permitted combination of operands. 2) The set of such acts specified by a rule, or the rule itself. 3) The act specified by a single computer instruction. 4) A program step undertaken or executed by a computer; for example, addition, multiplication, extraction, comparison, shift, transfer, etc. 5) The specific action performed by a logic element.

**OVC:** See *overflow counter (OVC)*.

**OVM:** See *overflow mode (OVM) bit*.

**overflow counter (OVC):** A 6-bit counter in status register ST0 that can be used to track overflows in the accumulator (ACC). The OVC is enabled only when the overflow mode (OVM) bit in ST0 is 0. When OVM = 0, the OVC is incremented by 1 for every overflow in the positive direction (too large a positive number) and decremented by 1 for every overflow in the negative direction (too large a negative number). The saturate (SAT) instruction modifies ACC to reflect the net overflow represented in the OVC.

**overflow flag (V):** A bit in status register ST0 that indicates when the result of an operation causes an overflow in the location holding the result (V = 1). If no overflow occurs, V is not modified.

**overflow mode (OVM) bit:** A bit in the status register ST0 that enables or disables overflow mode. When overflow mode is on (OVM = 1) and an overflow occurs, the CPU fills the accumulator (ACC) with a saturation value. When overflow mode is off (OVM = 0), the CPU lets ACC overflow normally but keeps track of each overflow by incrementing or decrementing by 1 the overflow counter (OVC) in ST0.

**P**

**P register:** See *product register (P)*.

**PAB:** See *program address bus (PAB)*.

**PAGE0 bit:** *PAGE0 addressing mode configuration bit.* This bit, in status register ST1, selects between two addressing modes: PAGE0 stack addressing mode (PAGE = 0) and PAGE0 direct addressing mode (PAGE0 = 1).

**PAGE0 direct addressing mode:** The direct addressing mode that uses data page 0 regardless of the value in the data page pointer (DP). This mode is available only when the PAGE0 bit in status register ST1 is 1. See also *DP direct addressing mode* and *PAGE0 stack addressing mode*.

**PAGE0 stack addressing mode:** The indirect addressing mode that references a value on the stack by subtracting a 6-bit offset from the current position of the stack pointer (SP). This mode is available only when the PAGE0 bit in status register ST1 is 0. See also *stack-pointer indirect addressing mode*.

**PC:** See *program counter (PC)*.

**pending interrupt:** An interrupt that has been requested but is waiting for approval from the CPU. See also *approve an interrupt request*.

**peripheral-interface logic:** Hardware that is responsible for handling communications between a processor and a peripheral.

**PH:** The high word (16 MSBs) of the P register.

**phases:** See *pipeline phases*.

**pipeline:** The hardware in the CPU that takes each instruction through eight independent phases for fetching, decoding, and executing. During any given CPU cycle, there can be up to eight instructions in the pipeline, each at a different phase of completion. The phases, listed in the order in which instructions pass through them, are fetch 1, fetch 2, decode 1, decode 2, read 1, read 2, execute, and write.

**pipeline conflict:** A situation in which two instructions in the pipeline try to access a register or memory location out of order, causing improper code operation. The C28x pipeline inserts as many inactive cycles as needed between conflicting instructions to prevent pipeline conflicts.

**pipeline freeze:** A halt in pipeline activity in one of the two decoupled portions of the pipeline. Freezes in the fetch 1 through decode 1 portion of the pipeline are caused by a not-ready signal from program memory. Freezes in the decode 2 through write portion are caused by lack of instructions in the instruction-fetch queue or by not-ready signals from memory.

**pipeline phases:** The eight stages an instruction must pass through to be fetched, decoded, and executed. The phases, listed in the order in which instructions pass through them, are fetch 1, fetch 2, decode 1, decode 2, read 1, read 2, execute, and write.

**pipeline-protection mechanism:** The mechanism responsible for identifying potential pipeline conflicts and preventing them by adding inactive cycles between the conflicting instructions.

**PL:** The low word (16 LSBs) of the P register.

**PM bits:** See *product shift mode (PM) bits*.

**PRDB:** See *program-read data bus (PRDB)*.

**priority:** See *interrupt priority*.

**product register (P):** This register, also called the P register, is given the results of most multiplications done by the CPU. The only other register that can be given the result of a multiplication is the accumulator (ACC). See also *PH* and *PL*.



**product shift mode (PM) bits:** A 3-bit field in status register ST0 that enables you to select one of eight product shift modes. The product shift mode determines whether or how the P register value is shifted before being used by an instruction. You have the choices of a left shift by 1 bit, no shift, or a right shift by N, where N is a number from 1 to 6.

**program address bus (PAB):** The bus that carries addresses for reads and writes from program space.

**program address generation logic:** This logic generates the addresses used to fetch instructions or data from program memory and places each address on the program address bus (PAB).

**program control logic:** This logic stores a queue of instructions that have been fetched from program memory by way of the program-read bus (PRDB). It also decodes these instructions and passes commands and constant data to other parts of the CPU.

**program counter (PC):** When the pipeline is full, the 22-bit PC always points to the instruction that is currently being processed—the instruction that has just reached the decode 2 phase of the pipeline.

**program-flow discontinuity:** A branching to a nonsequential address caused by a branch, a call, an interrupt, a return, or the repetition of an instruction.

**program-read data bus (PRDB):** The bus that carries instructions or data during reads from program space.

## R

**R1 phase:** See *read 1 (R1) phase*.

**R2 phase:** See *read 2 (R2) phase*.

**read 1 (R1) phase:** The fifth of eight pipeline phases an instruction passes through. In this phase, if data is to be read from memory, the CPU drives the address(es) on the appropriate address bus(es). See also *pipeline phases*.

**read 2 (R2) phase:** The sixth of eight pipeline phases an instruction passes through. In this phase, data addressed in the read 1 phase is fetched from memory. See also *pipeline phases*.

**ready signals:** When the core requests a read from or write to a memory device or peripheral device, that device can take more time to finish the data transfer than the core allots by default. Each device must use one of the core's *ready signals* to insert wait states into the data transfer when it needs more time. Wait-state requests freeze a portion of the pipeline if they are received during the fetch 1, read 1, or write pipeline phase of an instruction.

**real-time mode:** An emulation mode that enables you execute certain interrupts (time-critical interrupts), even when the CPU is halted. See also *stop mode*.

**real-time operating system interrupt (RTOSINT):** A maskable hardware interrupt generated by the emulation hardware in response to certain debug events. This interrupt should be disabled in the interrupt enable register (IER) and the debug interrupt enable register (DBGIER) unless there is a real-time operating system present in your debug system.

**reduced instruction set computer (RISC):** A computer whose instruction set and related decode mechanism are much simpler than those of microprogrammed complex instruction set computers.

**register addressing mode:** An addressing mode that enables you to reference registers by name.

**register conflict:** A pipeline conflict that would occur if an instruction read a register value before that value were changed by a prior instruction. The C28x pipeline inserts as many inactive cycles as needed between conflicting instructions to prevent register conflicts.

**register pair:** One of the pairs of CPU register stored to the stack during an automatic context save.

**repeat counter (RPTC):** The counter that is loaded by the RPT (repeat) instruction. The number in the counter is the number of times the instruction qualified by RPT is to be repeated after its initial execution.

**reserved:** A term used to describe memory locations or other items that you cannot use or modify.

**reset:** To return the DSP to a known state; an action initiated by the reset ( $\overline{RS}$ ) signal.

**return:** 1) The operation of forcing program control to a return address. 2) An instruction that performs such an operation. See also *call*.

**return address:** The address at which the CPU resumes processing after executing a subroutine or interrupt service routine.

**RISC:** See *reduced instruction set computer (RISC)*.

**rotate operation:** An operation performed by the ROL (rotate accumulator left) or ROR (rotate accumulator right) instruction. The operation, which involves a shift by 1 bit, can be seen as the rotation of a 33-bit value that is the concatenation of the carry bit (C) and the accumulator (ACC).

**RPTC:** See *repeat counter (RPTC)*.

**RTOSINT :** See *real-time operating system interrupt (RTOSINT)*.

**RUN command :** A debugger command used to execute all or a portion of a program. The RUN 1 command causes the debugger to execute a single instruction.

**run state:** A debug execution state. In this state, the CPU is executing code and servicing interrupts freely. See also *debug-halt state* and *single-instruction state*.

**S**

**select signal:** An output signal from the C28x that can be used to select specific memory or peripheral devices for particular types of read and write operations.

**scan controller:** A device that performs JTAG state sequences sent to it by a host processor. These sequences, in turn, control the operation of a target device.

**service an interrupt :** The CPU services an interrupt by preparing for and then executing the corresponding interrupt service routine. See also *interrupt request* and *approve an interrupt request*.

**set:** To set a bit is to write a 1 to it. If a bit is set, it contains 1. See also *clear*.

**sign extend:** To fill the unused most significant bits (MSBs) of a value with copies of the value's sign bit.

**sign-extension mode (SXM) bit:** A bit in status register ST0 that enables or suppresses sign extension. When sign-extension is enabled (SXM = 1), operands of certain instructions are treated as signed and are sign extended during shifting.

**single-instruction state:** A debug execution state. In this state, the CPU executes one instruction and then returns to the debug-halt state. See also *debug-halt state* and *run state*.

**16-bit operation:** An operation that reads or writes 16 bits.

**software interrupt:** An interrupt initiated by an instruction. See also *hardware interrupt*.

**SP:** See *stack pointer (SP)*.

**SPA bit:** See *stack pointer alignment (SPA) bit*.

**ST0:** See *status registers ST0 and ST1*.

**ST1:** See *status registers ST0 and ST1*.

**stack :** The C28x stack is a software stack implemented by the use of a stack pointer (SP). The SP, a 16-bit CPU register, can be used to reference a value in the first 64K words of data memory (addresses  $00\ 0000_{16}$ – $00\ FFFF_{16}$ ).

**stack pointer (SP):** A 16-bit CPU register that enables you to use any portion of the first 64K words of data memory as a software stack. The SP always points to the next empty location in the stack.

**stack pointer alignment (SPA) bit:** A bit in status register ST1 that indicates whether an ASP instruction has forced the SP to align to the next even address (SPA = 1).

**stack-pointer indirect addressing mode:** The indirect addressing mode that references a data-memory value at the current position of the stack pointer (SP). See also *PAGE0 stack addressing mode*.

**status registers ST0 and ST1:** These CPU registers contain control bits that affect the operation of the C28x and contain flag bits that reflect the results of operations.

**STEP command:** A debugger command that causes the debugger to single-step through a program. The STEP1 command causes the debugger to execute a single instruction.

**stop mode:** An emulation mode that provides complete control of program execution. When the CPU is halted in stop mode, all interrupts (including reset and nonmaskable interrupts) are ignored until the CPU receives a directive to run code again. See also *real-time mode*.

**suppress sign extension:** Prevent sign extension from occurring during a shift operation. See also *sign extend*.

**SXM bit:** See *sign-extension mode (SXM) bit*.

**T**

**T register:** The primary function of this register, also called the multiplicand register, is to hold one of the values to be multiplied during a multiplication. The following shift instructions use the four LSBs to hold the shift count: ASR (arithmetic shift right), LSL (logical shift left), LSR (logical shift right), and SFR (shift accumulator right). The T register can also be used as a general-purpose 16-bit register.

**TAP:** See *test access port (TAP)*.

**target device/system:** The device/system on which the code you have developed is executed.

**TC bit:** See *test/control flag (TC)*.

**test access port (TAP):** A standard communication port defined by IEEE standard 1149.1–1990 included in the DSP to implement boundary scan functions and/or to provide communication between the DSP and emulator.

**test/control flag (TC):** A bit in status register ST0 that shows the result of a test performed by the TBIT (test bit) instruction or the NORM (normalize) instruction.

**test-logic-reset:** A test and emulation logic condition that occurs when the TRST signal is pulled low or when the TMS signal is used to advance the JTAG state machine to the TLR state. This logic is a different type than that used by the CPU, which resets functional logic.

**32-bit operation:** An operation that reads or writes 32 bits.

**TI extension pins:** See *EMU0 and EMU1 pins*.

**time-critical interrupt:** An interrupt that must be serviced even when background code is halted. For example, a time-critical interrupt might service a motor controller or a high-speed timer. See also *debug interrupt enable register (DBGIER)*.

**U**

**USER1–USER12 interrupts:** The interrupt vector table contains twelve locations for user-defined software interrupts. These interrupts, called USER1–USER12 in this document, can be initiated only by way of the TRAP instruction.

## V

**V bit (overflow flag):** A bit in status register ST0 that indicates when the result of an operation causes an overflow in the location holding the result ( $V = 1$ ). If no overflow occurs, V is not modified.

**vector:** See *interrupt vector*.

**vector location:** See *interrupt vector location*.

**vector map (VMAP) bit:** A bit in status register ST1 that determines the addresses to which the interrupt vectors are mapped. When  $VMAP = 0$ , the interrupt vectors are mapped to addresses  $00\ 0000_{16}$ – $00\ 003F_{16}$  in program memory. When  $VMAP = 1$ , the vectors are mapped to addresses  $3F\ FFC0_{16}$ – $3F\ FFFF_{16}$  in program memory.

**vector table:** See *interrupt vector table*.

## W

**W phase:** See *write (W) phase*.

**wait state:** A cycle during which the CPU waits for a memory or peripheral device to be ready for a read or write operation.

**watchpoint:** A place in a routine where it is to be halted if an address or an address and data combination match specified compare values. When a watchpoint is reached, the routine is halted and the CPU enters the debug-halt state.

**word:** In this document, a word is 16 bits unless specifically stated to be otherwise.

**write (W) phase:** The last of eight pipeline phases an instruction passes through. In this phase, if a value or result is to be written to memory, the CPU sends to memory the destination address and the data to be written. See also *pipeline phases*.

## Z

**zero fill:** Fill the unused low- and/or high-order bits of a value with 0s.

**zero flag (Z):** A bit in status register ST0 that indicates when the result of an operation is 0 ( $Z = 1$ ).

# Index

---

---

---

2s complement subtraction to ARx C-14

## A

ABORTI 6-18

ABORTI instruction 7-15

ABS ACC 6-19

ABSTC ACC 6-20

access to CPU registers during emulation 7-16

access to memory during emulation 7-16

accesses

polite 7-16

rude 7-16

Accumulator B-4

accumulator 2-6

AH (high word) 2-6

AH.LSB 2-7

AH.MSB 2-7

AL (low word) 2-6

AL.LSB 2-7

AL.MSB 2-7

portions that are individually accessible 2-7

ADD ACC, #16bit<#0..15 6-22

ADD ACC, loc16< T 6-24

ADD ACC, loc16<#0 6-25

ADD AX, loc16 6-27

ADD loc16, AX 6-28

ADD loc16, #16bitSigned 6-29

ADDB ACC, #8bit 6-30

ADDB AX, #8bitSigned 6-31

ADDB SP, #7bit 6-32

ADDB XARn, #7bit 6-33

ADDCL ACC, loc32 6-34

ADDCU ACC, loc16 6-35

ADDL ACC, loc32 6-36

ADDL ACC, P < PM 6-37

ADDL loc32 ACC 6-38

address buses 1-9

address counters FC IC and PC 4-5

address maps 1-8

address reach B-5

address register arithmetic unit (ARAU) 1-5 2-2

addressing modes 5-1 5-2

byte 5-31

direct 2-10

direct addressing 5-2

indirect 2-12

indirect addressing 5-2

program space 5-30

register 5-25

stack addressing 5-2

Addressing Modes for "loc16" or "loc32" table 5-4

Addressing Modes Select Bit (AMODE) 5-4

ADDRH register 7-24

ADDRL register 7-24

ADDU ACC, loc16 6-39

ADDUL P, loc32 6-40

ADDUL ACC loc32 6-41  
 ADRK #8bit 6-42  
 AH (high word of accumulator) 2-6  
 AL (low word of accumulator) 2-6  
 align stack pointer 6-52  
 AL.LSB (part of accumulator) 2-7  
 AL.MSB (part of accumulator) 2-7  
 AMODE 5-4, B-9, E-4  
 AMODE bit 1-2  
 analysis resources  
   breakpoints 7-19  
   clearing resources 7-30  
   counters 7-20  
   data logging 7-23  
   sharing resources 7-30  
   watchpoints 7-19  
 AND ACC, #16bit < #0..15 6-43  
 AND ACC, loc16 6-43 6-44  
 AND AX, loc16, #16bit 6-45  
 AND IER, #16bit 6-46  
 AND IFR, #16bit 6-47  
 AND loc16, AX 6-48  
 AND AX, loc16 6-49  
 AND IER and OR IER instructions  
   note about RTOSINT 3-9  
 AND loc16, #16bitSigned 6-50  
 ANDB AX, #8bit 6-51  
 architectural overview 1-1  
 architecture differences between the C27x and the  
   C28x E-1  
 architecture differences between the C2xLP and the  
   C28x B-1  
 arithmetic logic unit (ALU) 1-5  
 arithmetic shift right 6-53  
 ARP B-9  
 ARx registers C-14  
 ASP 6-52  
 ASR AX, #1016 6-53  
 ASR AX, T 6-54  
 ASR64 ACC:P, #1..16 6-55  
 ASR64 ACC:P, T 6-56  
 ASRL ACC, T 6-57  
 atomic arithmetic logic unit (ALU) 2-2  
 Auxiliary registers B-4

auxiliary registers  
   AR0–AR5, XAR6, XAR7, 2-12  
   pointer 2-34

## B

B 16bitOffset, COND 6-58  
 B0 Memory Map B-14  
 background code 7-6  
 BANZ D-4  
 BANZ 16bitOffset, ARn-- 6-59  
 BAR 16bitOffset, ARn, ARm, EQ 6-60  
 barrel shifter 1-5  
 benchmark counter 7-20  
 BF 16bitOffset, COND 6-61  
 bits  
   auxiliary register pointer (ARP) 2-34  
   carry (C) 2-25  
   debug enable mask (DBGM) 2-37  
   debug interrupt enable register (DBGIER) 3-10  
   emulation access enable (EALLOW) 2-35  
   IDLE status (IDLESTAT) 2-35  
   interrupt enable register (IER) 3-9  
   interrupt flag register (IFR) 3-7  
   interrupt global mask (INTM) 2-37  
   loop instruction status (LOOP) 2-35  
   negative flag (N) 2-24  
   overflow counter (OVC) 2-16  
   overflow flag (V) 2-21  
   overflow mode (OVM) 2-32  
   PAGE0 addressing mode configuration 2-36  
   product shift mode (PM) 2-19  
   sign-extension mode 2-32  
   stack pointer alignment (SPA) 2-36  
   test/control flag (TC) 2-30  
   vector map (VMAP) 2-36  
   zero flag (Z) 2-25  
 block diagram of the CPU, figure 2-3  
 branch 6-58  
   instructions introduced 2-39  
 break event 7-6  
 break events 7-7  
 breakpoints 7-19  
   caution about time-critical ISRs 7-11  
 Building a C27x Object File From C27x Source,  
   figure E-8



## buses

- data-/program-write data 1-9
- data-read address 1-9
- data-read data 1-9
- data-write address 1-9
- program address 1-9
- program-read data 1-9
- special operations 1-10
- summary table 1-10

## C

C bit 2-25

C27MAP 6-62

C27OBJ 6-63

C27x Compatible Mapping of ABlocks M0 and M1 figure E-7

C27x object mode E-8

C28ADDR 6-64

C28MAP 6-65

C28OBJ 6-66

C28x and C2xLP Flags table D-2

C28x features B-2

C28x Product Mode Shifter table B-8

C28x Status Register ST0 B-7

C28x Status Register ST1 B-7

C2xLP C-1

C2xLP and C28x architectural differences B-1

C2xLP and C28x Differences in Instructions and Registers, table C-13

C2xLP and C28x Differences in Interrupts, table C-10

C2xLP and C28x Differences in Memory Maps, table C-12

C2xLP and C28x Differences in Status Registers table C-11

C2xLP Instructions and C28x Equivalent Instructions, table D-3

C2xLP Product Mode Shifter B-8

C2xLP Status Register ST0 B-7

C2xLP Status Register ST1 B-7

calls 2-39

Carry bit (C) B-10

carry bit (C) 2-25

caution: breakpoints within time-critical interrupt service routines 7-11

central processing unit (CPU) 1-4, 2-2

reset 3-23

*in real-time mode debug-halt state* 7-9

circular addressing modes 5-21

clear the AMODE bit 6-67

clear the OBJMODE bit 6-63

CLRC AMODE 6-67

CLRC M0M1MAP 6-68

CLRC OBJMODE 6-69

CLRC OVC 6-70

CLRC XF 6-71

CLRC mode 6-72

CMP AX, loc16 6-74

CMP loc16, #16bitSigned 6-75

CMP64 ACC:P 6-77

CMPB AX, #8bit 6-79

CMPL ACC, loc32 6-80

CMPL ACC, P &lt; PM 6-81

CMPR 0 6-82

## code

clear IFR C-8

conversion from C2xLP C-8

IER/IFR C-7

interrupt C-8

migration reference tables C-10

code examples C-7

Code for a Full Context Save/Restore for C28x vs C27x, figure E-6

compare 6-74

compatibility 1-2

compiler 5-7

core 1-2

components 1-4

diagram 1-4

count sign bits 6-83

counters 7-20

CPU 1-4, 2-2

See also central processing unit

reset 3-23

*in real-time mode debug-halt state* 7-9

CPU registers 2-4

CSB ACC 6-83

**D**

data buses 1-9  
 data log interrupt (DLOGINT) 3-6, 7-27  
     vector 3-5  
 data logging 1-5, 7-23  
     accessing emulation registers 7-26  
     creating a transfer buffer 7-23  
     examples 7-28  
     interrupt (DLOGINT) 3-6, 7-27  
     interrupt vector 3-5  
     with end address 7-29  
     with word counter 7-28  
 data logging end-address control register 7-26  
 Data memory B-14  
 data move contents 6-89  
 Data Page Pointer B-5  
 data page pointer (DP) 2-10  
 data space, address map 1-8  
 data-/program-write data bus (DWDB) 1-9  
 data-read address bus (DRAB) 1-9  
 data-read data bus (DRDB) 1-9  
 data-write address bus (DWAB) 1-9  
 DBGIER A-2  
 DBGM E-4  
     debug enable mask bit B-9  
 DBGSTAT register 7-15, G-6  
 debug  
     enable mask bit (DBGM) 2-37  
     event 7-6  
     execution control modes 7-7  
     halt state 7-6  
     interface 7-3  
     sharing resources 7-30  
     terminology 7-6  
 debug enable mask bit (DBGM) 2-37  
     role in accesses during emulation 7-16  
     set during interrupt handling 3-15, 3-20  
 debug interrupt enable register A-2  
 debug interrupt enable register (DBGIER) 3-6, 3-8,  
     3-10, 7-9  
     quick reference figure A-9  
 Debug interrupt–enable register B-4  
 debug status register (DBGSTAT) 7-15, G-6

debug-and-test direct memory access  
     (DT-DMA) 1-5  
     mechanism 7-16  
 debug-halt state 7-7, 7-9  
 DEC loc16 6-84  
 decoupled pipeline segments 4-4  
 decrement by 1 6-84  
 development interface 7-2  
 diagnostic features for emulation 7-31  
 diagrams  
     CPU 2-3  
     multiplication 2-42, 2-43  
     pipeline activity 4-8  
     pipeline conflict 4-13, 4-14  
     relationship between pipeline and address count-  
         ers 4-6  
     shift operations 2-45  
     T320C28x DSP core 1-4  
 DINT 6-85  
 Direct Addressing Mode 5-2, 5-8  
 direct addressing mode B-5  
 Direct Addressing Mode Mapping, figure B-6  
 direct addressing mode on the C2XLP B-5  
 direct memory access mechanism for emula-  
     tion 7-16  
 disable write access to protected registers 6-91  
 discontinuity delay 4-11  
 DMA control register 7-25  
 DMA ID register 7-25  
 DMA registers (data logging) 7-25  
 DMAC ACC:P, loc32, \*XAR7 6-86  
 DMOV loc16 6-89  
 DP 2-10  
 DT–DMA 1-5  
 DT-DMA mechanism 7-16  
 DT-DMA request process, figure 7-17  
 dual multiply and accumulate 6-86

**E**

EALLOW 6-90, B-9  
 EALLOW bit 2-35  
 EALLOW instruction, use in data logging 7-23,  
     7-26  
 EDIS 6-91  
 EDIS instruction, use in data logging 7-24, 7-27

EINT 6-92  
 EMU0/1 signals 7-4  
 emulation  
   data logging 7-23  
   disabled 7-5  
   enabled 7-5  
   features 1-5, 7-2  
   logic 1-4, 1-5, 7-15  
 Emulation access enable bit B-9  
 emulation access enable bit (EALLOW) 2-35  
 emulation signals 1-6  
 enable maskable interrupts 6-92  
 enable write access to protected space 6-90  
 end address register (data logging) 7-26  
 ESTOP0 6-93  
 ESTOP1 6-94  
 event counter 7-20  
 events  
   break 7-6  
   debug 7-6  
 examples  
   code C-7  
   data logging with end address 7-29  
   data logging with word counter 7-28  
 execution control modes  
   real-time mode 7-9  
   stop mode 7-7

**F**

fast function call 6-95  
 FC (fetch counter) 4-5  
 fetch counter (FC) 4-5  
 FFC XAR7, 22bit 6-95  
 find the maximum 6-149  
 find the minimum 6-153  
 flags, interrupt flag register (IFR) 3-7  
 FLIP AX 6-96  
 flip order of bits in AX register 6-96  
 flow chart of recommended migration steps, figure C-4  
 flow charts  
   handling DT-DMA request 7-17  
   interrupt initiated by the TRAP instruction 3-18  
   interrupt operation, maskable interrupts 3-12  
 foreground code 7-6

full context save C-8  
 Full Context Save/Restore, figure E-5  
 Full Context Save/Restore Comparison, table C-9

**G**

global space B-14  
 Glossary G-1  
 GREG register D-14

**H**

hardware reset 3-23  
 hardware reset interrupt 3-17  
 header, dimensions 14-pin 7-3  
 high-impedance mode 7-5

**I**

I/O space B-14  
 IACK #16bit 6-97  
 IC (instruction counter) 4-5  
 IDLE 6-98  
 IDLE status bit (IDLESTAT) 2-35  
 IDLESTAT B-9  
 IDLESTAT bit 2-35  
 IEEE 1149.1 (JTAG) signals 7-3  
 IER A-2  
 IFR A-2  
 illegal-instruction trap 3-17, 3-22  
 IMACL P, loc32, \*XAR7 6-100  
 improvements over the C2xLP CPU B-2  
 IMPYAL P, XT, loc32 6-103  
 IMPYL ACC, XT, loc32 6-105  
 IMPYL P, XT, loc32 6-106  
 IMPYSL P, XT, loc32 6-107  
 IMPYXUL P, XT, loc32 6-109  
 IN loc16, \*(PA) 6-111  
 INC loc16 6-113  
 increment by 1 6-113  
 Indirect Addressing Mode 5-2, 5-10  
 individually accessible portions of the accumulator 2-7  
 instruction counter (IC) 4-5  
 Instruction Syntax Change, table E-12

- instruction-fetch mechanism 4-4
- instruction-not-available condition 4-10
- instructions
  - ABORTI (abort interrupt) 7-15
  - ABS ACC (Absolute Value of Accumulator) 6-19
  - ADD (add constant) 6-29
  - ADD AX (Add value to AX) 6-27
  - ADDACC (Add value to accumulator) 6-22
  - ADDB XARn, #7bit 6-33
  - ADDUACC (add unsigned value to accumulator) 6-39
  - ADRK (add to current register) 6-42
  - ASP (align stack pointer) 6-52
  - ASRAX (arithmetic shift right) 6-53
  - B (branch) 6-58
  - C27MAP (set the M0M1MAP bit) 6-62
  - C27OBJ (clear the OBJMODE bit) 6-63
  - CLRCAMODE (clear the AMODE bit) 6-67
  - CMP AX (compare) 6-74
  - conditional 2-39
  - CSBACC (count sign bits) 6-83
  - DEC (decrement) 6-84
  - DMA ACC (dual multiply and accumulate) 6-86
  - DMOV (data move contents) 6-89
  - EALLOW (enable write access to protected space) 6-90
  - EDIS (disable write access to protected registers) 6-91
  - EINT (enable maskable interrupts) 6-92
  - FFC XAR7,22bit (fast function call) 6-95
  - FLIP AX (flip order of bits in AX register) 6-96
  - IACK, #16bit (interrupt acknowledge) 6-97
  - INCloc16 (increment by 1) 6-113
  - INTR (software interrupt) 3-17
  - LB \*XAR7 (long indirect branch) 6-119
  - LC \*XAR7 (long indirect call) 6-121
  - LCR #22bit (long call using RPC) 6-123
  - LOOPNZ loc16, #16bit (loop while not zero) 6-125
  - LPADDR (set the AMODE bit) 6-129
  - LRET (long return) 6-130
  - LSLACC, #1..16 (logical shift left) 6-133
  - LSR AX, #1..16 (logical shift right) 6-140
  - MAC (multiply and accumulate, preload T) 4-16
  - MAX AX, loc16 (find the maximum) 6-149
  - MIN AX, loc16 (find the minimum) 6-153
  - MOV AR6/7, loc16 (load auxiliary register) 6-160
  - MOV AX, loc16 (load AX) 6-161
- instructions (continued)
  - MOV DP, #10bit (load data page pointer) 6-162
  - MOV IER, loc16 (load the interrupt enable register) 6-163
  - MOV loc16, #16bit (save 16-bit constant) 6-164
  - MOV loc16, OVC (store the overflow counter) 6-173
  - MOV OVC, loc16 (load the overflow counter) 6-176
  - MOV\*(0:16bit), loc16 (move value) 6-156
  - OR ACC, loc16 (bitwise OR) 6-257
  - OUT \*(PA), loc16 (output data to port) 6-265
  - POP ACC (pop top of stack to accumulator) 6-267
  - PREAD (read from program memory) 4-16
  - PREAD loc16, \*XAR7 (read from program memory) 6-282
  - PUSH ACC (push accumulator onto stack) 6-284
  - PWRITE (write to program memory) 4-16
  - PWRITE \*XAR7, loc16 (write to program memory) 6-299
  - ROL ACC (rotate accumulator left) 6-310
  - ROR ACC (rotate accumulator right) 6-311
  - SAT ACC (saturate accumulator) 6-313
  - SUBR loc16, AX 6-354
  - TBIT 6-359
  - TCLR 6-361
  - TRAP (software trap) 3-17 6-363
  - TSET 6-365
  - UOUT 6-366
  - TEST 6-362
  - XB 6-368
  - XBANZ 6-372
  - XCALL 6-374
  - XMACDP 6-380
  - XMACP 6-378
  - XOR 6-382
  - XORB 6-387
  - XPREAD 6-388
  - XPWRITE 6-390
  - XRET 6-391
  - XRETC 6-392
  - ZALR 6-394
  - ZAP 6-395
  - ZAPA 6-396
  - XB 6-370
- interface, memory 1-9
- interrupt, signals 1-6
- interrupt acknowledge 6-97

- interrupt-control registers (IFR, IER, DBIER) 2-14
  - interrupt enable C-10
  - Interrupt enable register B-4
  - interrupt enable register C-10
  - interrupt enable register (IER) 3-6, 3-8, 7-9
    - quick reference figure A-8
  - Interrupt flag register B-4
  - interrupt flag register A-2, C-10
  - interrupt flag register (IFR) 3-7
    - quick reference figure A-7
  - Interrupt global mask bit (INTM) B-10
  - interrupt global mask bit (INTM) 2-37, 3-6, 7-9
  - interrupt handling in real-time mode 7-9
  - interrupt handling in stop mode 7-7
  - interrupt instructions
    - AND IER 3-8
    - AND IFR 3-7
    - INTR 3-8, 3-17
    - OR IER 3-8
    - OR IFR 3-7
    - POP DBGIER 3-10
    - PUSH DBGIER 3-10
    - TRAP 3-17
  - interrupt service routine (ISR) 3-4
    - caution about breakpoints 7-11
  - interrupt vectors 1-7
  - interruptions 2-39, 3-1
    - aborting 7-15
    - control registers (IFR, IER, DBIER) 2-14
    - data log interrupt (DLOGINT) 3-6, 7-27
    - effect on instructions in pipeline 4-4
    - general purpose 3-6
    - handling information by emulation mode and state 7-13
    - INT1–INT14, 3-6
    - maskable 3-6
      - definition 3-2
      - flow chart of operation 3-12
    - NMI 3-21
    - nonmaskable 3-17
      - definition 3-2
    - operation
      - overview 3-2
      - real-time mode 7-9
      - standard 3-11
      - stop mode 7-7
    - overview 3-2
  - interruptions (continued)
    - real-time operating system interrupt (RTO-SINT) 3-6
    - special cases, clearing IFR flag bit after TRAP instruction 3-7, 3-8
    - time-critical 7-6
      - serviced in real-time mode 7-9
    - vectors 3-4
  - INTM B-11
  - INTR INTx 6-114
  - INTR instruction 3-17, C-10
  - IRET 6-116
  - IRET instruction 7-15, E-5
- J**
- JTAG, signals 7-3
  - JTAG header to interface a target to the scan controller, figure 7-3
  - JTAG port 7-1
- L**
- LACL dma C-15
  - LB \*XAR7 6-119
  - LB 22bit 6-120
  - LC \*XAR7 6-121
  - LC 22bit 6-122
  - LCR #22bit 6-123
  - LCR \*XARn 6-124
  - load auxiliary register 6-160
  - load AX 6-161
  - load data page pointer 6-162
  - load the interrupt enable register 6-163
  - load the overflow counter 6-176
  - loc16 5-2
  - loc32 5-2
  - logical shift left 6-133
  - logical shift right 6-140
  - long call using RPC 6-123
  - long indirect branch 6-119
  - long indirect call 6-121
  - long return 6-130
  - LOOP B-9
  - LOOP bit 2-35
  - Loop instruction status bit B-9

loop instruction status bit (LOOP) 2-35  
 loop while not zero 6-125  
 LOOPNZ loc16, #16bit 6-125  
 LOOPZ loc16, #16bit 6-127  
 LPADDR 6-129  
 LRET 6-130  
 LRETE 6-131  
 LRETER 6-132  
 LSL ACC, #1..16 6-133  
 LSL ACC, T 6-134  
 LSL AX, #1016 6-135  
 LSL AX, T 6-136  
 LSL64 ACC:P, #1..16 6-137  
 LSL64 ACC:P, T 6-138  
 LSL ACC, T 6-139  
 LSR AX, #1016 6-140  
 LSR AX, T 6-141  
 LSR64 ACC:P, #1..16 6-142  
 LSR64 ACC:P, T 6-143  
 LSRL ACC, T 6-144

## M

M0 M1 map bit B-9  
 MOM1MAP B-9, E-4  
 MAC P, loc16, 0:pma 6-145  
 MAC P, loc16, \*XAR7 6-147  
 Mapping of memory blocks B0 and B1 on C27 E-7  
 maskable interrupts 3-6  
   definition 3-2  
   flow chart of operation 3-12  
 MAX AX, loc16 6-149  
 MAXCUL P, loc32 6-150  
 MAXL ACC, loc32 6-152  
 memory 1-9  
   address map 1-8  
   interface 1-9  
   reserved addresses 1-8  
 memory map B-12, B-13, E-2  
 Memory space B-12  
 memory wrappers 1-11  
 migration 1-2  
 migration flow C-3  
 migration guidelines C-1

MIN AX, loc16 6-153  
 MINCUL P, loc32 6-154  
 MINL ACC, loc32 6-155  
 mixing of C2xLP code and C28x code segments C-6  
 modes  
   high-impedance 7-5  
   nonpreemptive 7-16  
   normal with emulation disabled 7-5  
   normal with emulation enabled 7-5  
   preemptive 7-16  
   real-time 7-7, 7-9  
   slave 7-5  
   stop 7-7  
 MOV \*(0:16bit), loc16 6-156  
 MOV AX, loc16 6-161  
 MOV ACC, #16bit<#0..15 6-157  
 MOV ACC, loc16 < T 6-158  
 MOV ACC, loc16<#0..16 6-159  
 MOV AR6, loc16 6-160  
 MOV DP, #10bit 6-162  
 MOV IER, loc16 6-163  
 MOV loc16, #0 6-166  
 MOV loc16, #16bit 6-164  
 MOV loc16, \*(0:16bit) 6-165  
 MOV loc16, AX 6-169  
 MOV loc16, AX COND 6-170  
 MOV loc16, IER 6-172  
 MOV loc16, OVC 6-173  
 MOV loc16, P 6-174  
 MOV OVC, loc16 6-176  
 MOV PH, loc16 6-177  
 MOV PL, loc16 6-178  
 MOV PM, AX 6-179  
 MOV T, loc16 6-180  
 MOV TL, #0 6-181  
 MOV loc16, ARn 6-168  
 MOV XARn, PC 6-182  
 MOV loc16, T 6-175  
 MOVA T, loc16 6-183  
 MOVAD T, loc16 6-185  
 MOV B ACC, #8bit 6-187  
 MOV B AR6/7, #8bit 6-188  
 MOV B AX.LSB, loc16 6-190  
 MOV B AX.MSB, loc16 6-192

MOVB AX, #8bit 6-189  
 MOVB loc16, AX.LSB 6-196  
 MOVB loc16, AX.MSB 6-198  
 MOVB loc16, #8bit, COND 6-194  
 MOVB XARn, #8bit 6-200  
 MOVDL XT, loc16 6-201  
 move value 6-156  
 MOVH loc16, P 6-203  
 MOVH loc16, ACC, < #1..8 6-167, 6-202  
 MOVL ACC, loc32 6-204  
 MOVL ACC, P < PM 6-205  
 MOVL loc32, ACC 6-206  
 MOVL loc32, XAR0 6-210  
 MOVL loc32, ACC, COND 6-207  
 MOVL loc32, P 6-209  
 MOVL loc32, XT 6-211  
 MOVL P, ACC 6-212  
 MOVL P, loc32 6-213  
 MOVL XAR0, loc32 6-214  
 MOVL XARn, #22bit 6-215  
 MOVL XT, loc32 6-216  
 MOVP T, loc16 6-217  
 MOVS, T, loc16 6-218  
 MOVU ACC, loc16 6-220  
 MOVU loc16, OVC 6-221  
 MOVU OVC, loc16 6-222  
 MOVW DP, #16bit 6-223  
 MOVX TL, loc16 6-224  
 MOVZ AR005, loc16 6-225  
 MOVZ DP, #10bit 6-226  
 MPY ACC, loc16, #16bit 6-227  
 MPY ACC, T, loc16 6-228  
 MPY P, loc16, #16bit 6-229  
 MPY P, T, loc16 6-230  
 MPYA P, loc16, #16bit 6-231  
 MPYA P, T, loc16 6-233  
 MPYB ACC, T, #8bit 6-235  
 MPYB P, T, #8bit 6-236  
 MPYS P, T, loc16 6-237  
 MPYU ACC, T, loc16 6-240  
 MPYU P, T, loc16 6-239  
 MPYXU ACC, T, loc16 6-241  
 MPYXU P, T, loc16 6-242

Multiplicand register B-4  
 multiplicand register (T) 2-8  
 multiplier, operation 2-41

## N

N bit 2-24  
 NASP 6-243  
 NEG ACC 6-244  
 NEG AX 6-245  
 NEG64 ACC:P 6-246  
 Negative flag B-8  
 negative flag (N) 2-24  
 NEGTC ACC 6-248  
 NMI Instruction C-10  
 NMI interrupt 3-21  
 NMI pin 3-21  
 nonmaskable interrupts 3-17  
   definition 3-2  
 nonpreemptive mode 7-16  
 NOP {\*ind}{,ARPN} 6-250  
 NORM ACC, \*ind 6-251  
 NORM ACC, XARn++ 6-253  
 normal mode 7-5  
 NOT ACC 6-255  
 NOT AX 6-256

## O

OBJMODE B-9, E-4, E-9  
 OBJMODE bit 1-2  
 operating modes, selecting by using TRST EMU0,  
   and EMU1, 7-5  
 operations  
   multiply 2-41  
   shift 2-44  
   special bus 1-10  
   stack 2-12  
 OR ACC, loc16 6-257  
 OR ACC, #16bit < #0..15 6-258  
 OR AX, loc16 6-259  
 OR loc16, AX 6-263  
 OR IER, #16bit 6-260  
 OR IFR, #16bit 6-261  
 OR loc16, #16bit 6-262

ORB AX, #8bit 6-264  
 OUT \*(PA), loc16 6-265  
 output data to port 6-265  
 OVC, overflow counter B-9  
 OVC (overflow counter) 2-16  
 overflow counter (OVC) 2-16  
 Overflow flag B-8  
 overflow flag (V) 2-21  
 Overflow mode (OVM) B-10  
 overflow mode bit (OVM) 2-32  
 OVM B-11  
 OVM bit 2-32

## P

P register 2-9  
 PAGE0 addressing mode configuration bit B-9  
 PAGE0 bit 2-36  
 PC (program counter) 2-14, 4-5  
 phases of pipeline 4-2  
 pipeline 2-40  
     decoupled segments 4-4  
     freezes in activity 4-10  
     instruction-fetch mechanism 4-4  
     operations not protected by 4-16  
     phases 4-2  
     protection 4-12  
     visualizing activity 4-7  
     wait states 4-10  
 pipeline phases 4-2  
 PM bits 2-19  
 POP ACC 6-267  
 POP AR1:AR0 6-268  
 POP AR1H:AR0H 6-269  
 POP AR3:AR2 6-268  
 POP AR5:AR4 6-268  
 POP DBGIER 6-270  
 POP DP 6-271  
 POP DP:ST1 6-272  
 POP IFR 6-273  
 POP loc16 6-274  
 POP P 6-275  
 POP RPC 6-276  
 POP ST0 6-277  
 POP ST1 6-278  
 POP T:ST0 6-279  
 pop top of stack to accumulator 6-267  
 POP XAR0 6-280  
 POP XAR1 6-280  
 POP XAR2 6-280  
 POP XAR3 6-280  
 POP XAR4 6-280  
 POP XAR5 6-280  
 POP XAR6 6-280  
 POP XAR7 6-280  
 POP XT 6-281  
 PREAD loc16, \*XAR7 6-282  
 preemptive mode 7-16  
 process for handling a DT-DMA request, figure 7-17  
 Product Mode Shifter B-8  
 Product register B-4  
 product register (P) 2-9  
 Product shift mode B-8  
 product shift mode bits (PM) 2-19  
 program address bus (PAB) 1-9, 4-4  
 Program counter B-4  
 program counter C-14  
 program counter (PC) 2-14, 4-5  
 program flow 2-39  
 Program space B-12  
 program space, address map 1-8  
 program-space read and write 1-10  
 program-address counters 4-5  
 program-read data bus (PRDB) 1-9  
 PUSH ACC 6-284  
 push accumulator onto stack 6-284  
 PUSH AR1:AR0 6-285  
 PUSH AR1H:AR0H 6-286  
 PUSH AR3:AR2 6-285  
 PUSH AR5:AR4 6-285  
 PUSH DBGIER 6-287  
 PUSH DP 6-288  
 PUSH DP:ST1 6-289  
 PUSH IFR 6-290  
 PUSH loc16 6-291  
 PUSH P 6-292  
 PUSH RPC 6-293  
 PUSH ST0 6-294



PUSH ST1 6-295  
 PUSH T:ST0 6-296  
 PUSH XAR0 6-297  
 PUSH XAR1 6-297  
 PUSH XAR2 6-297  
 PUSH XAR3 6-297  
 PUSH XAR4 6-297  
 PUSH XAR5 6-297  
 PUSH XAR6 6-297  
 PUSH XAR7 6-297  
 PUSH XT 6-298  
 PWRITE \*XAR7, loc16 6-299

## Q

QMACL P, loc32, \*XAR7 6-300  
 QMACL P, loc32, \*XAR7++, 6-300  
 QMPYAL P, XT, loc32 6-302  
 QMPYL P, XT, loc32 6-304  
 QMPYL ACC, XT, loc32 6-305  
 QMPYSL P, XT, loc32 6-306  
 QMPYUL P, XT, loc32 6-308  
 QMPYXUL P, XT, loc32 6-309

## R

read from program memory 6-282  
 reads and writes, unprotected 4-16  
 real-time mode 7-7, 7-9  
   figure of execution states 7-10  
 real-time mode versus stop mode, figure 7-12  
 real-time operating system interrupt (RTO-SINT) 3-6, 7-14  
 Register Addressing Mode 5-2  
 register addressing modes 5-25  
 register changes B-4  
 register modifications B-3, E-2  
 register quick reference A-1  
   figures A-3  
 registers  
   accumulator 2-6  
   ADDRH 7-24  
   ADDRL 7-24  
   after reset 3-23  
   auxiliary registers (XAR0 – XAR7) 2-12

registers (continued)  
   conflicts, protection against 4-13  
   CPU registers (summary) 2-4  
   data page pointer (DP) 2-10  
   debug interrupt enable register (DBGIER) 3-8  
   DMA control register 7-25  
   end address register (data logging) 7-26  
   interrupt-control registers (IFR, IER, DBGIER) 2-14  
   interrupt enable register (IER) 3-8  
   interrupt flag register (IFR) 3-7  
   multiplicand (T) 2-8  
   product register (P) 2-9  
   program counter (PC) 2-14  
   quick reference A-1  
   quick reference figures A-3  
   return program counter (RPC) 2-14  
   stack pointer (SP) 2-11  
   start address register (data logging) 7-25  
   status register ST0, 2-14, 2-16  
   status register ST1, 2-14, 2-34  
   T register 2-8  
 registers after reset 3-23  
 repeat counter (RPTC) 2-39  
 repeat instructions C-13  
 repeatable instructions D-9, E-13  
 reserved addresses 1-8  
 Reserved memory B-14  
 reset 1-3  
 reset and interrupt signals 1-6  
 reset conditions B-10  
 Reset Conditions of Internal Registers, table B-10  
 reset input signal (RS) 3-23  
 reset of CPU 3-23  
 Reset Values of the Status and Control Registers, table A-2  
 Return Program Counter 2-5  
 Return program counter B-4  
 return program counter (RPC) 2-14  
 returns 2-39  
 ROL ACC 6-310  
 ROR ACC 6-311  
 rotate accumulator left 6-310  
 RPC (return program counter) 2-14  
 RPT #8bit 6-312  
 RPT loc16 6-312  
 RPTC (repeat counter) 2-39

run state 7-7, 7-10

## S

SARAM mapping C-13

SAT ACC 6-313

SAT64 ACC:P 6-314

save 16-bit constant 6-164

SB 8bitOffset, COND 6-316

SBBU ACC, loc16 6-317

SBF 8bitOffset, EQ 6-318

SBF 8bitOffset, NEQ 6-318

SBF 8bitOffset, NTC 6-318

SBF 8bitOffset, TC 6-318

selecting device operating modes 7-5

set the AMODE bit 6-129

set the M0M1MAP bit 6-62

SETC C 6-320

SETC DBGM 6-320

SETC INTM 6-320

SETC OVM 6-320

SETC PAGE0 6-320

SETC SXM 6-320

SETC TC 6-320

SETC VMAP 6-320

SETC M0M1MAP 6-322

SETC mode 6-320

SETC OBJMODE 6-323

SETC XF 6-324

SFR ACC, #1..16 6-325

SFR ACC, T 6-326

shift operations 2-44

shifter 1-5

shifting values in the accumulator 2-8

Sign extension mode (SXM) B-10

signal descriptions 14-pin header 7-4

signals 1-6

description 14-pin header 7-4

EMU0 7-5

EMU1 7-5

PD (VCC) 7-3

TCK 7-3

TCK\_RET 7-3

TDI 7-3

TDO 7-3

signals (continued)

TMS 7-3

TRST 7-3, 7-5

sign-extension mode bit (SXM) 2-32

single-instruction state 7-7

slave mode 7-5

software breakpoints 7-7

software interrupts 3-17

SPA bit 2-36

special bus operations 1-11

SPM +1 6-327

SPM +4 6-327

SPM -1 6-327

SPM -2 6-327

SPM -3 6-327

SPM -4 6-327

SPM -5 6-327

SPM -6 6-327

SPM 0 6-327

SQRA loc16 6-329

SQRS loc16 6-331

ST0 A-2

ST0 Register Bits, table E-3

ST1 A-2

ST1 Register Bits, table E-4

stack 2-11

Stack Addressing Mode 5-2, 5-9

Stack Pointer B-4

stack pointer (SP) 2-11

Stack pointer alignment bit B-9

stack pointer alignment bit (SPA) 2-36

Stack space B-14

start address register (data logging) 7-25

status bits

ARP 2-34

C 2-25

DBGM 2-37

EALLOW 2-35

IDLESTAT 2-35

INTM 2-37

LOOP 2-35

N 2-24

OVC 2-16

OVM 2-32

PAGE0, 2-36

PM 2-19

- status bits (continued)
    - SPA 2-36
    - SXM 2-32
    - TC 2-30
    - V 2-21
    - VMAP 2-36
    - Z 2-25
  - status register A-2
  - Status Register Bits B-11
  - status register changes B-7
  - Status Register Comparison Between C2xLP and C28x, figure B-7
  - Status Registers B-5
  - status registers
    - ST0, 2-14, 2-16
      - quick reference figure A-4*
    - ST1, 2-14, 2-34
      - quick reference figure A-5*
  - stop mode 7-7
    - figure of execution states 7-8
  - stop mode versus real-time mode, figure 7-12
  - store the overflow counter 6-173
  - SUB loc16, AX 6-339
  - SUB ACC, #16bit < #0..15 6-337
  - SUB ACC, loc16 < #0 6-333
  - SUB ACC, loc16 < T 6-335
  - SUB AX, loc16 6-338
  - SUBB ACC, #8bit 6-340
  - SUBB XARn, #7bit 6-342
  - SUBB SP, #7bit 6-341
  - SUBBL ACC, loc32 6-343
  - SUBCU ACC, loc16 6-345
  - SUBCU instruction E-14
  - SUBCUL ACC, loc32 6-347
  - SUBL ACC, loc32 6-350
  - SUBL ACC, P < PM 6-351
  - SUBL loc32, ACC 6-353
  - SUBR loc16, AX 6-354
  - SUBRL loc32, ACC 6-355
  - SUBU ACC, loc16 6-356
  - SUBUL ACC, loc32 6-357
  - SUBUL P, loc32 6-358
  - suspend program execution 7-7
  - SXM bit 2-32
  - syntax change
    - increment/decrement C-15
    - repeat instructions C-15
    - shift C-15
- T**
- T register 2-8
  - T320C28x core 1-2
  - TBIT loc16, #16bit 6-359
  - TBIT loc16, T 6-360
  - TC bit 2-30
  - TCK signal 7-4
  - TCLR loc16, #bit 6-361
  - TDI signal 7-4
  - terminology, debug 7-6
  - test, sharing resources 7-30
  - TEST ACC 6-362
  - test clock return signal (TCK\_RET) 7-3
  - Test/control flag (TC) B-10
  - test/control flag bit (TC) 2-30
  - testing and debugging, signals 1-6
  - time-critical interrupts
    - definition 7-6
    - serviced in real-time mode 7-9
  - TMS signal 7-4
  - TMS320C20x C-1
  - TMS320C24x C-1
  - TMS320C24xx C-1
  - TRAP #VectorNumber 6-363
  - TRAP instruction 3-18, C-10
  - TRST signal 7-4, 7-5
  - TSET loc16, #16bit 6-365
  - types of signals 1-6
- U**
- unprotected program-space reads and writes 4-16
  - UOUT \*(PA),loc16 6-366
- V**
- V bit 2-21
  - Vector map bit B-9
  - vector map bit (VMAP) 2-36

Vectors B-12  
VMAP E-4

## W

wait states, effects on pipeline 4-10  
wait-in-reset mode 7-5  
watchpoints 7-19  
write to program memory 6-299

## X

XAR6 register 2-12  
XARn registers E-9  
XB \*AL 6-368  
XB pma, COND 6-370  
XB pma, \*, ARPn 6-369  
XBANZ pma, \* 6-372  
XBANZ pma, \*, ARPn 6-372  
XBANZ pma, \*++ 6-372  
XBANZ pma, \*++, ARPn 6-372  
XBANZ pma, \*-- 6-372  
XBANZ pma, \*--, ARPn 6-372  
XBANZ pma, \*0++ 6-372  
XBANZ pma, \*0++, ARPn 6-372  
XBANZ pma, \*0-- 6-372

XBANZ pma, \*0--, ARPn 6-372  
XCALL \*AL 6-374  
XCALL pma, \*, ARPn 6-375  
XCALL pma, COND 6-376  
XF E-4  
XF pin status bit B-9  
XMAC P, loc16, \*(pma) 6-378  
XMACD P, loc16, \*(pma) 6-380  
XOR AX, loc16 6-384  
XOR ACC, #16bit < #0..15 6-383  
XOR ACC, loc16 6-382  
XOR loc16, AX 6-385  
XOR loc16, #16bit 6-386  
XORB AX, #8bit 6-387  
XPREAD loc16, \*(pma) 6-388  
XPREAD loc16, \*AL 6-389  
XPWRITE \*AL, loc16 6-390  
XRET 6-391  
XRETC COND 6-392

## Z

ZAP OVC 6-395  
ZAPA 6-396  
Zero flag B-8  
zero flag bit (Z) 2-25

## IMPORTANT NOTICE

Texas Instruments Incorporated and its subsidiaries (TI) reserve the right to make corrections, modifications, enhancements, improvements, and other changes to its products and services at any time and to discontinue any product or service without notice. Customers should obtain the latest relevant information before placing orders and should verify that such information is current and complete. All products are sold subject to TI's terms and conditions of sale supplied at the time of order acknowledgment.

TI warrants performance of its hardware products to the specifications applicable at the time of sale in accordance with TI's standard warranty. Testing and other quality control techniques are used to the extent TI deems necessary to support this warranty. Except where mandated by government requirements, testing of all parameters of each product is not necessarily performed.

TI assumes no liability for applications assistance or customer product design. Customers are responsible for their products and applications using TI components. To minimize the risks associated with customer products and applications, customers should provide adequate design and operating safeguards.

TI does not warrant or represent that any license, either express or implied, is granted under any TI patent right, copyright, mask work right, or other TI intellectual property right relating to any combination, machine, or process in which TI products or services are used. Information published by TI regarding third-party products or services does not constitute a license from TI to use such products or services or a warranty or endorsement thereof. Use of such information may require a license from a third party under the patents or other intellectual property of the third party, or a license from TI under the patents or other intellectual property of TI.

Reproduction of TI information in TI data books or data sheets is permissible only if reproduction is without alteration and is accompanied by all associated warranties, conditions, limitations, and notices. Reproduction of this information with alteration is an unfair and deceptive business practice. TI is not responsible or liable for such altered documentation. Information of third parties may be subject to additional restrictions.

Resale of TI products or services with statements different from or beyond the parameters stated by TI for that product or service voids all express and any implied warranties for the associated TI product or service and is an unfair and deceptive business practice. TI is not responsible or liable for any such statements.

TI products are not authorized for use in safety-critical applications (such as life support) where a failure of the TI product would reasonably be expected to cause severe personal injury or death, unless officers of the parties have executed an agreement specifically governing such use. Buyers represent that they have all necessary expertise in the safety and regulatory ramifications of their applications, and acknowledge and agree that they are solely responsible for all legal, regulatory and safety-related requirements concerning their products and any use of TI products in such safety-critical applications, notwithstanding any applications-related information or support that may be provided by TI. Further, Buyers must fully indemnify TI and its representatives against any damages arising out of the use of TI products in such safety-critical applications.

TI products are neither designed nor intended for use in military/aerospace applications or environments unless the TI products are specifically designated by TI as military-grade or "enhanced plastic." Only products designated by TI as military-grade meet military specifications. Buyers acknowledge and agree that any such use of TI products which TI has not designated as military-grade is solely at the Buyer's risk, and that they are solely responsible for compliance with all legal and regulatory requirements in connection with such use.

TI products are neither designed nor intended for use in automotive applications or environments unless the specific TI products are designated by TI as compliant with ISO/TS 16949 requirements. Buyers acknowledge and agree that, if they use any non-designated products in automotive applications, TI will not be responsible for any failure to meet such requirements.

Following are URLs where you can obtain information on other Texas Instruments products and application solutions:

### Products

Amplifiers	<a href="http://amplifier.ti.com">amplifier.ti.com</a>
Data Converters	<a href="http://dataconverter.ti.com">dataconverter.ti.com</a>
DLP® Products	<a href="http://www.dlp.com">www.dlp.com</a>
DSP	<a href="http://dsp.ti.com">dsp.ti.com</a>
Clocks and Timers	<a href="http://www.ti.com/clocks">www.ti.com/clocks</a>
Interface	<a href="http://interface.ti.com">interface.ti.com</a>
Logic	<a href="http://logic.ti.com">logic.ti.com</a>
Power Mgmt	<a href="http://power.ti.com">power.ti.com</a>
Microcontrollers	<a href="http://microcontroller.ti.com">microcontroller.ti.com</a>
RFID	<a href="http://www.ti-rfid.com">www.ti-rfid.com</a>
RF/IF and ZigBee® Solutions	<a href="http://www.ti.com/lprf">www.ti.com/lprf</a>

### Applications

Audio	<a href="http://www.ti.com/audio">www.ti.com/audio</a>
Automotive	<a href="http://www.ti.com/automotive">www.ti.com/automotive</a>
Broadband	<a href="http://www.ti.com/broadband">www.ti.com/broadband</a>
Digital Control	<a href="http://www.ti.com/digitalcontrol">www.ti.com/digitalcontrol</a>
Medical	<a href="http://www.ti.com/medical">www.ti.com/medical</a>
Military	<a href="http://www.ti.com/military">www.ti.com/military</a>
Optical Networking	<a href="http://www.ti.com/opticalnetwork">www.ti.com/opticalnetwork</a>
Security	<a href="http://www.ti.com/security">www.ti.com/security</a>
Telephony	<a href="http://www.ti.com/telephony">www.ti.com/telephony</a>
Video & Imaging	<a href="http://www.ti.com/video">www.ti.com/video</a>
Wireless	<a href="http://www.ti.com/wireless">www.ti.com/wireless</a>

Mailing Address: Texas Instruments, Post Office Box 655303, Dallas, Texas 75265  
Copyright © 2009, Texas Instruments Incorporated