

68EVB912B32UM/D

February 1997

M68EVB912B32
EVALUATION BOARD
USER'S MANUAL

Motorola reserves the right to make changes without further notice to any products herein to improve reliability, function or design. Motorola does not assume any liability arising out of the application or use of any product or circuit described herein; neither does it convey any license under its patent rights nor the rights of others. Motorola products are not designed, intended, or authorized for use as components in systems intended for surgical implant into the body, or other applications intended to support or sustain life, or for any other application in which the failure of the Motorola product could create a situation where personal injury or death may occur. Should Buyer purchase or use Motorola products for any such unintended or unauthorized application, Buyer shall indemnify and hold Motorola and its officers, employees, subsidiaries, affiliates, and distributors harmless against all claims, costs, damages, and expenses, and reasonable attorney fees arising out of, directly or indirectly, any claim of personal injury or death associated with such unintended or unauthorized use, even if such claim alleges that Motorola was negligent regarding the design or manufacture of the part.

TABLE OF CONTENTS

CHAPTER 1 GENERAL INFORMATION

| | |
|---|-----|
| 1.1 INTRODUCTION..... | 1-1 |
| 1.2 GENERAL DESCRIPTION AND FEATURES..... | 1-1 |
| 1.3 FUNCTIONAL OVERVIEW..... | 1-4 |
| 1.4 EXTERNAL EQUIPMENT REQUIREMENTS..... | 1-7 |
| 1.5 EVB SPECIFICATIONS..... | 1-8 |
| 1.6 CUSTOMER SUPPORT..... | 1-9 |

CHAPTER 2 CONFIGURATION AND SETUP

| | |
|---|-----|
| 2.1 UNPACKING AND PREPARATION..... | 2-1 |
| 2.2 EVB CONFIGURATION..... | 2-1 |
| 2.3 EVB TO POWER SUPPLY CONNECTION..... | 2-3 |
| 2.4 EVB TO TERMINAL CONNECTION..... | 2-3 |
| 2.5 TERMINAL COMMUNICATIONS SETUP..... | 2-5 |
| 2.5.1 Communication Parameters..... | 2-5 |
| 2.5.2 Dumb-Terminal Setup..... | 2-5 |
| 2.5.3 Host-Computer Setup..... | 2-5 |
| 2.5.4 Changing the Baud Rate..... | 2-6 |

CHAPTER 3 OPERATION

| | |
|--|-----|
| 3.1 OPERATING MODES..... | 3-1 |
| 3.1.1 EVB Mode..... | 3-1 |
| 3.1.2 JUMP-EEPROM Mode..... | 3-2 |
| 3.1.3 POD (Probe) Mode..... | 3-2 |
| 3.1.3.1 Target Types Supported..... | 3-2 |
| 3.1.3.2 Target MCU Characteristics..... | 3-3 |
| 3.1.3.3 Programming the Target's EEPROM..... | 3-3 |
| 3.1.3.4 Controlling Target Execution..... | 3-3 |
| 3.1.4 BOOTLOAD Mode..... | 3-3 |
| 3.2 STARTUP..... | 3-4 |

| | |
|---|------|
| 3.2.1 Startup Procedure..... | 3-4 |
| 3.2.2 Operating Procedures..... | 3-5 |
| 3.2.2.1 EVB Mode..... | 3-5 |
| 3.2.2.2 JUMP-EEPROM Mode..... | 3-5 |
| 3.2.2.3 POD Mode..... | 3-6 |
| 3.2.2.4 BOOTLOAD Mode..... | 3-7 |
| 3.3 RESET..... | 3-7 |
| 3.4 ABORTING A USER PROGRAM..... | 3-8 |
| 3.5 USING D-BUG12 COMMANDS..... | 3-8 |
| 3.5.1 Command-Line Prompt..... | 3-8 |
| 3.5.2 Entering Commands..... | 3-8 |
| 3.5.3 Command-Set Summary..... | 3-9 |
| 3.6 D-BUG12 COMMAND SET..... | 3-12 |
| Assembler/Disassembler..... | 3-13 |
| Set Baud Rate..... | 3-16 |
| Block Fill..... | 3-17 |
| Breakpoint Set..... | 3-18 |
| Bulk Erase EEPROM..... | 3-20 |
| Call Subroutine..... | 3-21 |
| Specify Target MCU Device..... | 3-22 |
| Specify Target EEPROM Base Address..... | 3-26 |
| Erase Target Flash EEPROM..... | 3-28 |
| Program Target Flash EEPROM..... | 3-30 |
| Go Execute a User Program..... | 3-32 |
| Go Till..... | 3-33 |
| Onscreen Help Summary..... | 3-34 |
| Load S-Record File..... | 3-36 |
| Memory Display..... | 3-37 |
| Memory Display, Word..... | 3-38 |
| Memory Modify..... | 3-39 |
| Memory Modify, Word..... | 3-41 |
| Move Memory Block..... | 3-43 |
| Remove Breakpoints..... | 3-44 |
| Register Display..... | 3-45 |
| Specify Target EEPROM Register Address..... | 3-46 |
| Reset Target MCU..... | 3-48 |
| Register Modify..... | 3-49 |

| | |
|--|------|
| Stop Execution on Target MCU | 3-50 |
| Trace | 3-51 |
| Display Memory in S-Record Format..... | 3-53 |
| Verify S-Record File against Memory..... | 3-54 |
| Modify Register Value..... | 3-56 |
| 3.7 OFF-BOARD CODE GENERATION..... | 3-59 |
| 3.8 MEMORY USAGE..... | 3-59 |
| 3.8.1 Description..... | 3-59 |
| 3.8.2 Memory Map | 3-60 |
| 3.9 OPERATIONAL LIMITATIONS..... | 3-60 |
| 3.9.1 On-Chip RAM | 3-61 |
| 3.9.2 On-Chip EEPROM | 3-61 |
| 3.9.3 SCI Port Usage..... | 3-61 |
| 3.9.4 Dedicated MCU Pins | 3-61 |
| 3.9.5 Terminal Communications | 3-62 |

CHAPTER 4 HARDWARE REFERENCE

| | |
|--|------|
| 4.1 PCB DESCRIPTION..... | 4-1 |
| 4.2 CONFIGURATION HEADERS AND JUMPER SETTINGS..... | 4-1 |
| 4.3 POWER INPUT CIRCUITRY..... | 4-5 |
| 4.4 TERMINAL INTERFACE..... | 4-6 |
| 4.5 MICROCONTROLLER..... | 4-6 |
| 4.6 CLOCK CIRCUITRY..... | 4-8 |
| 4.7 RESET..... | 4-8 |
| 4.8 LOW-VOLTAGE INHIBIT..... | 4-8 |
| 4.9 BACKGROUND DEBUG MODE (BDM) INTERFACE..... | 4-8 |
| 4.10 PROTOTYPE AREA | 4-10 |
| 4.11 MCU CONNECTORS | 4-10 |

APPENDIX A S-RECORD FORMAT

| | |
|------------------------|-----|
| DESCRIPTION | A-1 |
| S-RECORD CONTENT | A-1 |
| S-RECORD TYPES | A-2 |
| S-RECORD EXAMPLE..... | A-3 |

APPENDIX B COMMUNICATIONS PROGRAM EXAMPLES

| | |
|--|-----|
| INTRODUCTION | B-1 |
| PROCOMM FOR DOS — IBM PC..... | B-1 |
| Setup | B-1 |
| S-Record Transfers to EVB Memory | B-3 |
| KERMIT FOR DOS — IBM PC..... | B-3 |
| Setup | B-3 |
| S-Record Transfers to EVB Memory | B-3 |
| KERMIT — SUN WORKSTATION..... | B-5 |
| Setup | B-5 |
| S-Record Transfers to EVB Memory | B-5 |
| MACTERMINAL — APPLE MACINTOSH..... | B-6 |
| Setup | B-6 |
| S-Record Transfers to EVB Memory | B-6 |
| RED RYDER — APPLE MACINTOSH..... | B-7 |
| Setup | B-7 |
| S-Record Transfers to EVB Memory | B-7 |

APPENDIX C D-BUG12 STARTUP CODE
APPENDIX D D-BUG12 CUSTOMIZATION DATA

| | |
|--|-----|
| INITIAL USER CPU REGISTER VALUES..... | D-3 |
| SysClk FIELD..... | D-3 |
| IOBase FIELD | D-3 |
| SCIBaudRegVal FIELD | D-4 |
| EEBase AND EESize FIELDS..... | D-4 |
| EEPROM ERASE/PROGRAM DELAY FUNCTION POINTER FIELD..... | D-5 |
| AUXILIARY COMMAND TABLE ENTRIES..... | D-5 |

APPENDIX E EEPROM BOOTLOADER

| | |
|---------------------------------|-----|
| SERIAL S-RECORD BOOTLOADER..... | E-1 |
| (E)rase..... | E-3 |
| (P)rogram..... | E-4 |
| (L)oadEE..... | E-4 |

| | |
|--|-----|
| VECTOR JUMP TABLE: INTERRUPT AND RESET ADDRESSES | E-4 |
| RELOADING AND CUSTOMIZING D-BUG12..... | E-5 |
| Obtaining D-Bug12 Upgrades | E-6 |
| Reloading D-Bug12..... | E-6 |
| Customizing D-Bug12..... | E-6 |

INDEX

LIST OF ILLUSTRATIONS

| | |
|--|------|
| Figure 1-1. EVB Layout and Component Placement | 1-3 |
| Figure 1-2. EVB Solder Side View | 1-4 |
| Figure 4-1. MCU I/O Headers P2, P3..... | 4-11 |
| Figure 4-2. MCU I/O Headers P4, P6..... | 4-12 |

LIST OF TABLES

| | |
|---|------|
| Table 1-1. EVB Specifications | 1-8 |
| Table 2-1. EVB Startup Mode Jumpers..... | 2-3 |
| Table 2-2. RS-232C Interface Cabling | 2-4 |
| Table 2-3. Communication Parameters | 2-5 |
| Table 3-1. D-Bug12 Command-Set Summary..... | 3-9 |
| Table 3-2. M68HC11 to CPU12 Instruction Translation | 3-14 |
| Table 3-3. CPU12 Registers | 3-56 |
| Table 3-4. Condition Code Register Bits..... | 3-56 |
| Table 3-5. Factory-Configuration Memory Map..... | 3-60 |
| Table 4-1. Jumper and Header Functions | 4-3 |
| Table 4-2. CPU Mode Selection..... | 4-6 |
| Table 4-3. BDM Connector Pin Assignments | 4-10 |



CHAPTER 1

GENERAL INFORMATION

1.1 INTRODUCTION

This manual provides the necessary information for using the M68EVB912B32 Evaluation Board (the EVB), an evaluation, debugging, and code-generation tool for the MC68HC912B32 Microcontroller Unit (MCU) devices. The manual includes:

- A general description of the EVB
- Configuration and setup instructions
- Startup and operating instructions
- Detailed descriptions of the operating firmware's command set
- A detailed hardware-reference section
- Appendices containing reference data

Additional reference items, such as schematic diagrams and parts lists, are shipped as part of the EVB package.

1.2 GENERAL DESCRIPTION AND FEATURES

The EVB is an economical tool for designing and debugging code for, and evaluating the operation of, the MC68HC912B32 MCU. By providing the essential MCU timing and I/O circuitry, the EVB simplifies user evaluation of prototype hardware and software.

The board consists of a 5.15 by 3.4 inch (13.1 by 8.64 cm) double-sided printed circuit board (PCB) that provides the platform for interface and power connections to the MC68HC912B32 MCU chip.

Figure 1-1 shows the EVB's layout and locations of the major components, as viewed from the component side of the board.

Hardware features of the low-cost EVB include:

- Double-sided PCB
- Single-supply +3 to +5 Vdc power input (P5)
- RS-232C interface
- BDM IN and BDM OUT connectors for remote debugging of a user's target system

- Header footprints for access to all MCU pins
- 16-MHz crystal for 8-MHz bus operation
- Headers for jumper selection of and connection to hardware options:⁽¹⁾
 - RS-232 isolation (W1, W2))
 - EVB mode selection (W3, W4)
 - MCU mode selection (W5, W6)
 - V_{pp}/V_{dd} selection (W7)
 - V_{pp} input (W8)
 - BDM IN (W9)
 - BDM OUT V_{dd}/reset disconnects (W10, W11)
 - BDM OUT (W12)
 - Low-Voltage Inhibit (LVI) reset (W15)
 - EXTAL source control and access (W16)
- Four 2x20 header connectors for access to the MCU's I/O lines (P2, P3, P4, and P6)
- Prototype expansion area for customized interfacing with the MCU
- Low-profile reset push-button switch (S1)
- Low-voltage inhibit protection (U3)

⁽¹⁾For full details of the jumper settings, refer to Table 4-1.

Firmware features include:

- The D-Bug12 monitor/debugger program, resident in on-chip Flash EEPROM
- Full support for either dumb-terminal or host-computer terminal interface
- Single-line assembler/disassembler
- File-transfer capability from a host computer to RAM or EEPROM, allowing off-board code generation
- Ability to program EEPROM on either the host EVB or a compatible target system

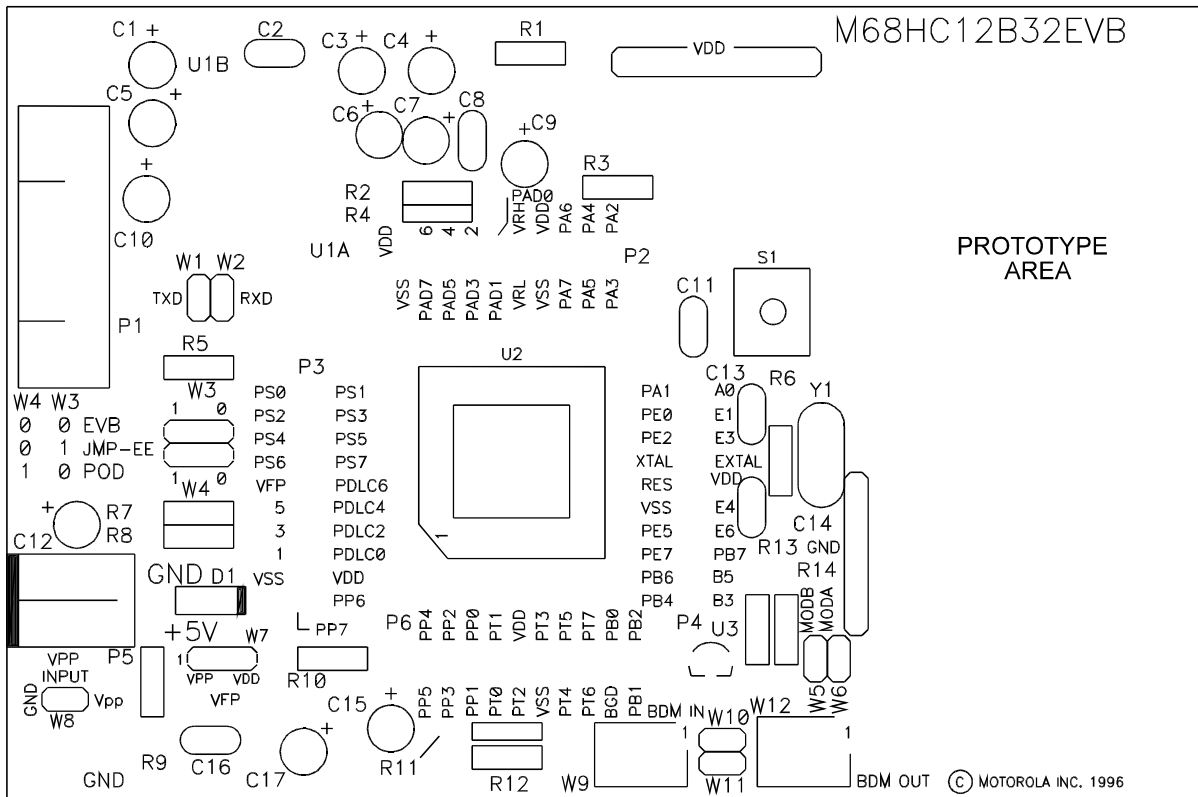

Figure 1-1. EVB Layout and Component Placement

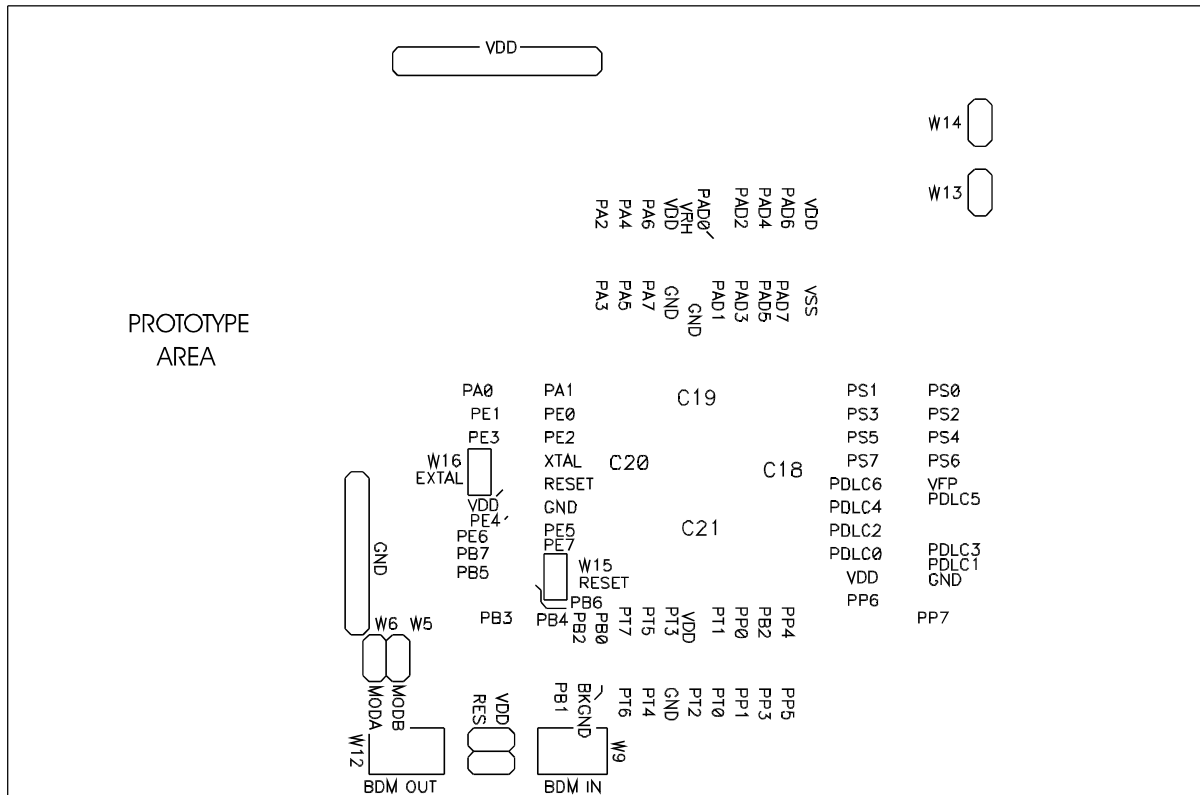

Figure 1-2. EVB Solder Side View

1.3 FUNCTIONAL OVERVIEW

The EVB is factory-configured to execute D-Bug12, the Flash EEPROM-resident monitor program, without further configuration by the user. It is ready for use with an RS-232C terminal for writing and debugging user code. Follow the setup instructions in Chapter 2 to prepare for operation.

The EVB can also be jumper-configured to:

- run a program directly out of EEPROM
- control a remote "pod" MCU via the Background Debug Mode interface
- reprogram EEPROM on either the host EVB or the "pod"

For the correct jumper settings, refer to **4.2 Configuration Headers and Jumper Settings**.

NOTES

The D-Bug12 operating instructions in this manual presume the factory-default memory configuration. Other configurations require different operating-software arrangements.

EEPROM resides in two areas of memory (refer to Table 3-5), which are referred to in this manual as "byte-erasable EEPROM" and "Flash EEPROM." This distinction is necessary because of the different ways in which they may be programmed and used.

D-Bug12 uses the MCU's Serial Communications Interface (SCI) for communications with the user terminal. For information on the port and its connector, refer to **2.4 EVB to Terminal Connection** and **4.4 Terminal Interface**.

If the MCU's single-wire Background Debug Mode (BDM) interface serves as the user interface, the SCI port becomes available for user applications. This mode requires either:

- another M68EVB912B32 and a host computer
- a background debug development tool, such as Motorola's Serial Debug Interface (SDI)

For more information, refer to the *Motorola Serial Debug Interface User's Manual*.

Two methods may be used to generate EVB user code:

1. For small programs or subroutines, D-Bug12's single-line assembler/disassembler may be used to place object code directly into the EVB's RAM or EEPROM.
2. For larger programs, P&E Microcomputer Systems' IASM12 or Motorola's MCUasm assembler may be used on a host computer to generate S-Record object files, which can then be loaded into the EVB's memory using D-Bug12's LOAD command.

The EVB features a prototype area, which allows custom interfacing with the MCU's I/O and bus lines. These connections are broken out via headers P2, P3, P4, and P6, which are immediately adjacent to the MCU on the board. Wire-wrap pins may be placed in these headers to connect to the prototyping area, as shown in Figure 1-1.

An on-board push-button switch, S1, provides for resetting the EVB hardware and restarting D-Bug12.

The EVB can begin operation in any of four jumper-selectable (W3, W4) modes at reset:

1. In **EVB mode**, program execution begins in one of two ways:
 - a. If D-Bug12 is resident in Flash EEPROM (i.e., if Mode 4 below has *not* been performed), D-Bug12 immediately issues its command prompt on the terminal display and waits for a user entry.

- b. If D-Bug12 has been replaced in Flash EEPROM with user code (i.e., Mode 4 below *has* been performed), execution begins with the user program.
2. In **JUMP-EE mode**, execution begins directly at location \$0D00 with the user code in byte-erasable EEPROM.
3. In **POD mode**, the board makes use of the BDM OUT header (W12) and uses the D-Bug12 commands to non-intrusively interrogate an external target MCU. Special prompts are displayed to let the user know if this mode is selected. If no external MCU is detected, the software informs the user.

The target's EEPROM may be programmed while the host M68EVB912B32 board is in EVB mode, using the D-Bug12 commands BULK, LOAD, FBULK and FLOAD.

4. In **BOOTLOAD mode**, the host EVB's byte-erasable or Flash EEPROM may be reprogrammed with user code. This mode may also be used to reload or customize D-Bug12.

D-Bug12 allows programming of the MC68HC912B32's on-chip EEPROM through commands that directly alter memory. For details of all D-Bug12 commands, refer to **3.6 D-Bug12 Command Set**.

When operating in EVB mode, the MCU must manage the EVB hardware and execute D-Bug12 *in addition* to serving as the user-application processor, there are a few restrictions on its use. For more information, refer to **3.9 Operational Limitations**.

1.4 EXTERNAL EQUIPMENT REQUIREMENTS

In addition to the EVB, the following user-supplied external equipment is required:

- Power supply — see Table 1-1 for voltage and current requirements.
- User terminal — options:
 - RS-232C dumb terminal — allows single-line on-board code assembly and disassembly.
 - Host computer with RS-232C serial port — allows off-board code assembly that can be loaded into the EVB's memory. Requires a user-supplied communications program capable of emulating a dumb terminal. Examples of acceptable communications programs are given in **Appendix B — Communications Program Examples**.
 - Host computer using the MCU's BDM interface — frees the target MCU's SCI port for user applications. This requires another M68EVB912B32 for use as the target or a background debug development tool, such as the Motorola Serial Debug Interface (SDI).
- Power-supply and terminal interconnection cables as required

For full details of equipment setup, cabling, and special requirements, refer to Chapter 2.

1.5 EVB SPECIFICATIONS

Table 1-1 lists the EVB specifications.

Table 1-1. EVB Specifications

| Characteristic | Specifications |
|--|---|
| MCU | MC68HC912B32 |
| MCU I/O ports | HCMOS compatible |
| Background Debug Mode interface (IN and OUT) | two 2x3 headers |
| Communications port | RS-232C DCE port |
| Power requirements, 16 MHz clock source | +2.7 Vdc to +5.0 Vdc @ 100 mA (max.) For low-voltage operation, refer to section 4.8. |
| Prototype area: Area Holes | approx. 1.5 x 3 in. (3.8 x 7.6 cm) approx. 15 wide x 31 high, on 0.1 in. (2.54 mm) centers |
| Board dimensions | 5.15 x 3.4 in. (13.1 x 8.64 cm) |

1.6 CUSTOMER SUPPORT

AUSTRALIA,

Melbourne – (61-3)887-0711

Sydney – (61-2)906-3855

BRAZIL

Sao Paulo – 55(11)815-4200

CANADA

B.C., Vancouver – (604)606-8502

ONTARIO, Toronto – (416)497-8181

ONTARIO, Ottawa – (613)226-3491

QUEBEC, Montreal – (514)333-3300

CHINA

Beijing – 86-10-6843722

FINLAND

Helsinki – 358-9-6824-400

FRANCE

Paris – 33134 635900

GERMANY

Langenhagen/Hannover – 49(511)786880

Munich – 49 89 92103-0

Nuremberg – 49 911 96-3190

Sindelfingen – 49 7031 79 710

Wiesbaden – 49 611 973050

HONG KONG

Kwai Fong – 852-6106888

Tai Po – 852-6668333

INDIA

Bangalore – (91-80)5598615

ISRAEL

Herzlia – 972-9-590222

ITALY

Milan – 39(2)82201

JAPAN

Fukuoka – 81-92-725-7583

Gotanda – 81-3-5487-8311

Nagoya – 81-52-232-3500

Osaka – 81-6-305-1802

Sendai – 81-22-268-4333

Takamatsu – 81-878-37-9972

Tokyo – 81-3-3440-3311

KOREA

Pusan – 82(51)4635-035

Seoul – 82(2)554-5118

MALAYSIA

Penang – 60(4)374514

MEXICO

Mexico City – 52(5)282-0230

Guadalajara – 52(36)21-8977

PUERTO RICO

San Juan – (809)282-2300

SINGAPORE – (65)4818188

SPAIN

Madrid – 34(1)457-8204

SWEDEN

Solna – 46(8)734-8800

SWITZERLAND

Geneva – 41(22)799 11 11

Zurich – 41(1)730-4074

TAIWAN

Taipei – 886(2)717-7089

THAILAND

Bangkok – 66(2)254-4910

UNITED KINGDOM

Aylesbury – 44 1 (296)395252

UNITED STATES

Phoenix, AZ – 1-800-441-2447

For a list of the Motorola sales offices and distributors: <http://www.mcu.mot.sps.com>

CHAPTER 2

CONFIGURATION AND SETUP

2.1 UNPACKING AND PREPARATION

Verify that the following items are present in the EVB package:

- The M68EVB912B32 board assembly
- Background Debug Mode(BDM) interface cable, 6-pin to 6-pin
- Warranty and registration cards
- EVB schematic diagram and parts list
- *M68EVB912B32 User's Manual*
- *MC68HC912B32 Technical Summary*
- *MC68HC912B32 Electrical Specifications Supplement*
- *CPU12 Reference Manual*
- *MC68HC12 Family Brochure*
- Assembly Language Development Toolset
- P&E Microcomputer Systems' IASM12 Assembler and user's manual on 3.5" diskette
- *Using D-Bug12 Callable Routines*

Save all packing materials for storing and shipping the EVB.

Remove the EVB from its anti-static container.

2.2 EVB CONFIGURATION

Because the EVB has been factory-configured to operate with D-Bug12, it is not necessary to change any of the jumper settings to begin operating immediately.

As shown in Table 2-1, only two jumpers (W3 and W4) should be changed during the course of factory-default EVB operation with D-Bug12.

Table 2-1. EVB Startup Mode Jumpers

| Jumper Positions | | Startup Mode |
|------------------|----|---|
| W3 | W4 | |
| 0 | 0 | EVB execution mode (default). D-Bug12 is executed from Flash EEPROM upon reset. The D-Bug12 prompt appears immediately on the terminal display. |
| 1 | 0 | JUMP-EEPROM mode. User code is executed from byte-erasable EEPROM upon reset. For more information, refer to 3.1 Operating Modes . |
| 0 | 1 | Remote Debugging through BDM OUT header (W12) |
| 1 | 1 | BOOTLOAD mode |

Other jumper settings affect the hardware setup and/or MCU operational modes. For an overview of all jumper-selectable functions, refer to **1.2 General Description and Features**. For details of the settings, see Table 4-1.

2.3 EVB TO POWER SUPPLY CONNECTION

The EVB requires a user-provided external power supply. See Table 1-1 for the voltage and current specifications. For full details of the EVB's power-input circuitry, refer to **4.3 Power Input Circuitry**.

A power supply with current-limiting capability is desirable. If this feature is available on the power supply, set it at 200 mA.

Connect the external power supply to connector P5 on the EVB, using 20 AWG or smaller insulated wire. Strip each wire's insulation 1/4 in. from the end, lift the P5 contact lever to release tension on the contact, insert the bare end of the wire into P5, and close the lever to secure the wire. Observe the polarity carefully.

CAUTION

Do not use wire larger than 20 AWG in connector P5. Larger wire could damage the connector.

2.4 EVB TO TERMINAL CONNECTION

For factory-default operation, connect the terminal to P1 on the EVB, as shown in Table 2-2. This setup uses the MCU's SCI port and its associated RS-232C interface for communications with the terminal device.

Standard, commercially available cables may be used in most cases. Note that the EVB requires only three of the RS-232C signals. Table 2-2 lists these signals and their pin assignments. Other signals have been routed through the RS-232C interface chip for proper levels. Some terminal interface programs require proper levels on all pins to function correctly.

The EVB's RS-232C connector, P1, is wired as Data Circuit-terminating Equipment (DCE) and employs a 9-pin subminiature D (DB-9) receptacle.

Most terminal devices — whether dumb terminals or the serial ports on host computers — are wired as Data Terminal Equipment (DTE) and employ 9- or 25-pin subminiature D (DB-9 or DB-25) plugs. In these cases, normal straight-through cabling is used between the EVB and the terminal. Adapters are readily available for connecting 9-pin cables to 25-pin terminal connectors.

If the terminal device is wired as DCE, the RXD and TXD lines must be cross-connected, as shown in Table 2-2. Commercial "null modem" adapter cables are available for this purpose.

Table 2-2. RS-232C Interface Cabling

| EVB P1 | DTE Signal | Terminal | | | |
|--|---------------------|-------------------------|-------|-------------------------------|-------|
| | | DTE ⁽¹⁾ Plug | | DCE ⁽²⁾ Receptacle | |
| | | DB-9 | DB-25 | DB-9 | DB-25 |
| 2 | Receive Data (RXD) | 2 | 2 | 3 | 3 |
| 3 | Transmit Data (TXD) | 3 | 3 | 2 | 2 |
| 5 | Ground (GND) | 5 | 7 | 5 | 7 |
| ⁽¹⁾ Normal (DCE-to-DTE) cable connections ⁽²⁾ Null modem (DCE-to-DCE) cable connections | | | | | |

Optionally, the MCU's Background Debug Mode (BDM IN — W12) interface can serve as the user interface. This setup makes the SCI port available for user applications. Additional hardware and software are required. For more information, refer to the documentation for the background debug development tool being used. This can be another M68EVB912B32 or a tool such as Motorola's Serial Debug Interface (SDI).

2.5 TERMINAL COMMUNICATIONS SETUP

2.5.1 Communication Parameters

The EVB's serial communications port uses the communication parameters listed in Table 2-3. Of these, only the baud rate can be changed. For instructions on changing it, refer to **2.5.4 Changing the Baud Rate**.

Table 2-3. Communication Parameters

| | |
|------------------|------|
| Baud Rate | 9600 |
| Data Bits | 8 |
| Stop Bits | 1 |
| Parity | none |

2.5.2 Dumb-Terminal Setup

Configuring a dumb terminal for use with the EVB consists of setting its parameters as shown in Table 2-3. Many terminals are configurable with externally accessible switches, but the procedure differs between brands and models. Consult the manufacturer's instructions for the terminal being used.

2.5.3 Host-Computer Setup

One advantage of using a host computer as the EVB's terminal is the ability to generate code off-board, for subsequent loading into the EVB's memory. It is thus desirable for the host to be capable of running programs such as P&E Microcomputer Systems' IASM12 or Motorola's MCUasm assembler. For more information, refer to **3.7 Off-Board Code Generation**.

To serve as the EVB's terminal, the host computer must have an RS-232C serial port and an installed communications program capable of operating with the parameters listed in Table 2-3.

Setting up the parameters is normally done within the communications program, after it has been started on the host. Usually, the setup can be saved in a configuration file so that it does not have to be repeated. Procedures vary between programs; consult the user's guide for the specific program.

Appendix B — Communications Program Examples provides examples of using some of the commonly available communications programs.

2.5.4 Changing the Baud Rate

The EVB's default baud rate for the RS-232C port is 9600. This can be changed in two ways:

- For temporary changes, use the D-Bug12 BAUD command. This change remains in effect only until the next reset or power-up, at which time the baud rate returns to 9600.
- For permanent changes, the D-Bug12 baud-rate initialization value stored in Flash EEPROM must be modified. For instructions, refer to **Appendix D — D-Bug12 Customization Data** and **Appendix E — EEPROM Bootloader**.



CHAPTER 3

OPERATION

3.1 OPERATING MODES

The EVB can operate in one of four jumper-selectable modes:

EVB mode — either D-Bug12 or the user code in Flash EEPROM executes.

JUMP-EEPROM mode — user code in byte-erasable EEPROM executes.

POD mode — D-Bug12 executes. EVB serves as the BDM probe for a target system.

BOOTLOAD mode — the host EVB's EEPROM may be reprogrammed.

The operating mode is determined by jumper headers W3 and W4, as shown in Table 4-1. The modes are described in the following three sections.

NOTE

When operating in EVB mode, the M68EVB912B32 cannot fully emulate a target system. The limitations are described in **3.9 Operational Limitations**.

Target system emulation may, however, be performed by using the EVB with D-Bug12 as an intelligent, non-intrusive BDM interface. This operation is described in **3.1.3 POD (Probe) Mode**.

3.1.1 EVB Mode

In the default EVB mode (W3-0 and W4-0), D-Bug12 begins execution immediately. The D-Bug12 prompt appears on the terminal and commands may be entered as described in **3.5 Using D-Bug12 Commands**.

If D-Bug12 has been replaced with user code in Flash EEPROM, execution begins with the user's program.

3.1.2 JUMP-EEPROM Mode

In this mode (W3-1 and W4-0), the EVB begins operation out of reset by executing the user program in byte-erasable EEPROM starting at address \$0D00, as shown in Table 3-5.

This mode is effected using the MCU's PAD0 line. User code may be programmed into byte-erasable EEPROM using the D-Bug12 commands listed in **3.5.3 Command-Set Summary**.

Control can be returned to D-Bug12 in the following ways:

1. Move the jumpers on headers W3 and W4 to position 0 and reset the EVB.
2. Terminate the user program with code that returns to D-Bug12 after execution has finished.

To return to D-Bug12 automatically after a user program has finished, include the following lines as the last instructions to be executed in the program:

```

STACKTOP:      equ    $0c00                ; stack at top of on-chip RAM
AltResetVect:  equ    $F7FE
;
;
;                                lds    #STACKTOP
;                                jmp    [AltResetVect,PCR] ; jump to start of D-Bug12

```

3.1.3 POD (Probe) Mode

In this mode (W3-0 and W4-1), the EVB and D-Bug12 serve as a POD ("probe") interface between a target system and the user. Communications between the EVB and the target are by means of the Background Debug Mode (BDM) interface, using the EVB header W12 (BDM OUT).

This arrangement allows the target system to perform true emulation of an application, as the BDM interface is non-intrusive upon the target's foreground operation. The target's on-chip resources are all available for the application. The target may be a second M68EVB912B32 board or any other M68HC12 system. D-Bug12 commands are entered as usual on the user terminal, which is served by the POD EVB.

3.1.3.1 Target Types Supported

All members of the M68HC12 family may be used in the target system.

3.1.3.2 Target MCU Characteristics

The following D-Bug12 commands must be used to inform D-Bug12 of the target MCU's essential operating characteristics in order to allow transparent modification of the target's EEPROM. For details, refer to the command descriptions in **3.6 D-Bug12 Command Set**.

DEVICE — specifies the target's microprocessor type

EEBASE — specifies the base address of the target's Flash EEPROM

REGBASE — specifies the base address of the target MCU's I/O registers

3.1.3.3 Programming the Target's EEPROM

The target MCU's on-chip byte-erasable or Flash EEPROM may be programmed from user-assembled S-Records on the host (terminal) computer by using the D-Bug12 commands BULK, LOAD, FBULK, and FLOAD. For details, refer to **3.6 D-Bug12 Command Set**.

3.1.3.4 Controlling Target Execution

All D-Bug12 commands that control the execution of user code may also be used in both EVB mode and POD mode. Two additional commands are available in POD mode:

- RESET — resets the target MCU and places it in active background mode
- STOP — halts program execution on the target

For details, refer to the command descriptions in **3.6 D-Bug12 Command Set**.

3.1.4 BOOTLOAD Mode

In this mode (W3-1 and W4-1), a user program may be loaded into the host EVB's byte-erasable or Flash EEPROM. D-Bug12 may be replaced as the startup "boot" program. This mode may also be used to reload or customize D-Bug12. The procedures are described in **Appendix E — EEPROM Bootloader**.

3.2 STARTUP

3.2.1 Startup Procedure

The following startup procedure includes a checklist of configuration and setup items. To begin operating the M68EVB912B32, follow these steps::

1. Configure the EVB if required — section 2.2.
2. Determine whether execution should begin in EVB mode (page 3-1), JUMP-EEPROM mode (page 3-2), POD mode (page 3-2), or BOOTLOAD mode (page 3-3). Set the jumpers on headers W3 and W4 accordingly — sections 2.2 and 3.1.
3. Connect the EVB to the external power supply — section 2.3.
4. Connect the EVB to the terminal — section 2.4.
5. Configure the terminal communications interface — section 2.5.

6. Apply power to the EVB and to the terminal. If the terminal is a host computer,
 - a. Verify that it has booted correctly.
 - b. Start the communications program for terminal emulation — section 2.5.3 and **Appendix B — Communications Program Examples**.
7. Reset the EVB by pressing and releasing the on-board reset switch (S1).

3.2.2 Operating Procedures

After starting the EVB in accordance with section 3.2.1, follow the operating procedure for the EVB mode that was selected: EVB mode, JUMP-EEPROM mode, POD mode, or BOOTLOAD mode. These procedures are described in the following sections.

3.2.2.1 EVB Mode

In EVB mode, the MC68HC912B32 begins executing code at the address contained in the alternate reset vector at \$F7FE (for information on the alternate reset and interrupt vector table, see **Vector Jump Table: Interrupt and Reset Addresses** on page E-4). The code pointed to by the alternate reset vector may either be D-Bug12 (factory default) or a user's program that has replaced D-Bug12 in Flash EEPROM.

D-Bug12 — upon reset, the D-Bug12 sign-on banner and prompt should appear on the terminal's display as follows:

```
D-Bug12 v 2.0.0
Copyright 1996 - 1997 Motorola Semiconductor
For Commands type "Help"
>
```

If the prompt does not appear, check all connections and verify that startup steps 1 through 7 in section 3.2.1 have been performed correctly.

When the prompt appears, D-Bug12 is ready to accept commands from the terminal as described in section 3.5.

User boot program — upon reset, the user program executes immediately. D-Bug12 commands are not available. Terminal communications take place either via the SCI under control of the user program or via the BDM interface and a serial debug interface tool such as Motorola's SDI.

3.2.2.2 JUMP-EEPROM Mode

In JUMP-EEPROM mode, the user code in byte-erasable EEPROM starting at address \$0D00 is executed immediately. Terminal communications are controlled by the user code via the SCI or by an appropriate serial debug tool via the BDM interface. For more information, refer to

3.1.2 JUMP-EEPROM Mode. Control can be returned to the D-Bug12 terminal prompt by doing one of the following:

1. terminating the user code with appropriate instructions — see section 3.1.2
2. pressing the reset button (S1)

3.2.2.3 POD Mode

In POD mode, the host EVB serves as a non-intrusive controller for the target system via the BDM interface. The host EVB begins executing code at the address contained in the alternate reset vector at \$F7FE (for information on the alternate reset and interrupt vector table, see **Vector Jump Table: Interrupt and Reset Addresses** on page E-4). The code pointed to by the alternate reset vector may either be D-Bug12 (factory default) or a user's program that has replaced D-Bug12 in Flash EEPROM.

D-Bug12 — upon power-up or reset, D-Bug12 attempts to establish communications with a target system connected to BDM OUT (W11). Communications are first attempted without resetting the target system. If communications cannot be established, the following message is displayed:

```
Can't Communicate With The Target Processor
To reset target, hit any key...
```

Pressing any key on the terminal's keyboard causes D-Bug12 to assert the target's reset pin for approximately 2 mS and try again to establish communications. If communications fail, the above error message is redisplayed. Once communications have been established with the target system, the D-Bug12 sign-on banner and prompt should appear on the terminal's display as follows:

```
D-Bug12 v 2.0.0
Copyright 1996 - 1997 Motorola Semiconductor
For Commands type "Help"
S>
```

If communications cannot be established with the target system after repeated attempts, check for the following possible problems:

- The host EVB's BDM OUT (W11) must be properly connected to the target system's BDM connector. If the target system is another EVB, make sure that the host EVB's BDM OUT is connected to target EVB's BDM IN (W9).
- If the target system is not another EVB, verify that its BDM connector is wired to the proper MCU signals on each pin.
- If the target MCU does not have any firmware to execute, it could "run away," possibly executing a STOP opcode and preventing BDM communications with the host EVB.

Thus, it is *strongly* recommended that, if the target system does not have firmware to execute at reset, the target MCU be initially configured to begin operation in Special

Single Chip mode. Resetting the target MCU in Special Single Chip mode places it in active background mode. See the target MCU's technical summary for details on setting the MCU operating mode.

Special D-Bug12 command-line prompts indicate the status of the target system:

```
S>                target is in active background mode
R>                target is running a user program
```

In addition to the normal D-Bug12 commands that control execution of user code, the RESET and STOP commands are available in POD mode. These commands are described in **3.6 D-Bug12 Command Set**.

D-Bug12 must be informed of the target MCU's basic operating parameters. Refer to section 3.1.3 for more information about setting up and using POD mode.

User boot program — upon reset, the user program executes immediately. D-Bug12 commands are not available. Communications with the user terminal and with the target system are controlled by the user program.

3.2.2.4 BOOTLOAD Mode

In BOOTLOAD mode, a user program may be loaded into the host EVB's byte-erasable or Flash EEPROM. If the user code replaces D-Bug12 in Flash EEPROM, it serves as the "boot" program when the EVB is restarted in EVB or POD mode. This procedure is described in **Appendix E — EEPROM Bootloader**.

3.3 RESET

EVB operation can be restarted at any time by activating the hardware reset function. Do this in one of two ways:

1. Press and release the on-board reset switch, S1 (always applicable).
2. Activate the external reset input if one has been provided for operation below 3.0 Vdc.

Note that the EVB's reset circuitry is associated with the low-voltage protection. For more information, refer to **4.7 Reset** and **4.8 Low-Voltage Inhibit**.

3.4 ABORTING A USER PROGRAM

When operating in EVB mode, the only way to recover from an erroneous or runaway user program is to press the reset switch (S1). If this becomes necessary, the jumpers on headers W3 and W4 should be set to execute D-Bug12 at reset instead of the flawed user program.

When operating in POD mode, the D-Bug12 RESET or STOP command can be used to regain control of the target system.

3.5 USING D-BUG12 COMMANDS

D-Bug12, the EVB's firmware-resident monitor program, provides a self-contained operating environment that allows writing, evaluation, and debugging of user programs.

3.5.1 Command-Line Prompt

D-Bug12 displays one of three command-line prompts, depending upon its operating mode and/or the state of the target system. When D-Bug12 is operating in the EVB mode, it displays the single character ">" at the beginning of a line when it is waiting for the user to enter a command. When a command is issued that causes user code to run, D-Bug12 places the terminal cursor on a blank line, where it remains until control returns to D-Bug12.

When operating in the POD mode, D-Bug12 displays one of two prompts, depending upon the state of the attached target system. When the target system is in active background mode (not running a user program), the two-character prompt "S>" is displayed, indicating that the target is stopped and not running a user program. When the target system is running a user program, the two-character prompt "R>" is displayed, indicating that the target is running a user program.

Because the M68HC12 Background Debug Mode interface allows the reading and writing of target system memory even when the target is running a user's program, the probe microcontroller is always available for the entry of commands. D-Bug12 commands that examine or modify target system memory may be issued when either the "S>" or "R>" prompt is displayed.

3.5.2 Entering Commands

Commands are typed on the terminal's D-Bug12 prompt line and executed when the carriage-return (ENTER) key is pressed. D-Bug12 then displays either the appropriate response to the command or an error indication.

The D-Bug12 command-line prompt is the greater-than sign (>). Type the command and any other required or optional fields immediately after the prompt, as follows:

command-line syntax:

```
<command> [ <parameter> ] . . . [ <parameter> ] <ENTER>
```

where:

<command> is the command mnemonic.

<parameter> is an expression or address.
 <ENTER> is the terminal keyboard's carriage-return or enter key.

NOTES

1. The command-line syntax is illustrated using the following special characters for clarification. *Do not* type these characters on the command line:

| | |
|--------|------------------------------|
| < > | required syntactical element |
| [] | optional field |
| ...[] | repeated optional fields |

2. Fields are separated by any number of space characters.
3. All numeric fields, unless noted otherwise, are interpreted as hexadecimal.
4. Command-line entries are case-insensitive and may be typed using any combination of upper- and lower-case letters.
5. A maximum of 80 characters, including the terminating carriage return, may be entered on the command line. After the 80th character, D-Bug12 automatically terminates the command-line entry and processes the characters entered to that point.
6. Before the <ENTER> or <RETURN> key is pressed, the command line may be edited using the backspace key. Receiving the backspace character causes D-Bug12 to delete the previously-received character from its input buffer and erase the character from the display.

3.5.3 Command-Set Summary

Table 3-1 summarizes the D-Bug12 commands. For detailed descriptions of each command, refer to **3.6 D-Bug12 Command Set**.

Table 3-1. D-Bug12 Command-Set Summary

| Command | Description |
|--|--------------------------------------|
| ASM <address> | Single-line assembler/disassembler |
| BAUD <BAUDRate> | Set the SCI communications baud rate |
| BF <StartAddress><EndAddress> [<Data>] | Block fill user memory with data |
| BR [<Address><Address>...] | Set/display user breakpoints |
| BULK | Bulk erase byte-erasable EEPROM |

Table 3-1. D-Bug12 Command-Set Summary (continued)

| Command | Description |
|---|---|
| CALL [<Address>] | Execute a user subroutine; return to D-Bug12 when finished |
| DEVICE [<i>see description</i>] | Select/define a new target MCU device |
| EEBASE <Address> | Inform D-Bug12 of the target's EEPROM base address |
| FBULK | Erase the target processor's on-chip Flash EEPROM |
| FLOAD <AddressOffset> | Program the target processor's on-chip Flash EEPROM from S-Records |
| G [<Address>] | Go — begin execution of user program |
| GT <Address> | Go Till — set a temporary breakpoint and begin execution of user program |
| HELP | Display D-Bug12 command set and command syntax |
| LOAD [<AddressOffset>] | Load user program in S-Record format* |
| MD <StartAddress> [<EndAddress>] | Memory Display — display memory contents in hex bytes/ASCII format |
| MDW <StartAddress> [<EndAddress>] | Memory Display Word — display memory contents in hex words/ASCII format |
| MM <Address> [<data>] | Memory Modify — interactively examine/change memory contents |
| MMW <address> [<data>] | Memory Modify Word — interactively examine/change memory contents |
| MOVE <StartAddress> <EndAddress> <DestAddress> | Move a block of memory |
| NOBR [<Address> <Address>...] | Remove individual user breakpoints |
| RD | Register Display — display the CPU register contents |
| REGBASE | Inform D-Bug12 of the target I/O register's base address |
| RESET | Reset the target CPU |
| RM | Register Modify — interactively examine/change CPU register contents |
| STOP | Stop execution of user code on the target processor and place it in background mode |

Table 3-1. D-Bug12 Command-Set Summary (continued)

| Command | Description |
|---|---|
| T [<Count>] | Trace — execute an instruction, disassemble it, and display the CPU registers |
| UPLOAD <StartAddress> <EndAddress> | Display memory contents in S-Record format* |
| VERF [<AddressOffset>] | Verify memory contents against S-Record Data |
| <RegisterName> <RegisterValue> | Set CPU <RegisterName> to <RegisterValue> |
| * Refer to Appendix A for S-Record information. | |

3.6 D-BUG12 COMMAND SET

In the following command descriptions, the examples represent what is seen on the terminal display. For clarity, the user's entry is underlined. This underlining *does not actually appear onscreen*.

A typical example looks like this:

| | |
|----------------------------------|--------------------------------------|
| > <u>baud 9600</u> | <i>user's entry</i> |
| Change Terminal BR, Press Return | <i>D-Bug12's response</i> |
| > | <i>D-Bug12 prompt for next entry</i> |

ASM**Assembler/Disassembler****ASM****syntax:**

```
ASM <Address>
```

where:

<Address> is a 16-bit hexadecimal number.

The assembler/disassembler is an interactive memory editor that allows memory contents to be viewed and altered using assembly language mnemonics. Each entered source line is translated into object code and placed into memory at the time of entry. When displaying memory contents, each instruction is disassembled into its source mnemonic form and displayed along with the hexadecimal object code and any instruction operands.

Assembler mnemonics and operands may be entered in any mix of upper and lower case letters. Any number of spaces may appear between the assembler prompt and the instruction mnemonic or between the instruction mnemonic and the operand. Numeric values appearing in the operand field are interpreted as *signed* decimal numbers. Placing a \$ in front of any number will cause the number to be interpreted as a hexadecimal number.

When an instruction is disassembled and displayed, the D-Bug12 prompt is displayed following the disassembled instruction. If a carriage return is the first non-space character entered following the prompt, the next instruction in memory is disassembled and displayed on the next line.

If a CPU12 instruction is entered following the prompt, the entered instruction is assembled and placed into memory. The line containing the new entry is erased and the new instruction is disassembled and displayed on the same line. The next instruction location is then disassembled and displayed on the screen.

The instruction mnemonics and operand formats accepted by the assembler follows the syntax as described in the *CPU12 Reference Manual*.

There are a number of M68HC11 instruction mnemonics that appear in the *CPU12 Reference Manual* that do not have directly equivalent CPU12 instructions. These mnemonics, listed in Table 3-2, are translated into functionally equivalent CPU12 instructions. To aid the current M68HC11 users who may desire to continue using the M68HC11 mnemonics, the disassembler portion of the assembler/disassembler recognizes the functionally equivalent CPU12 instructions and disassembles those instructions into the equivalent M68HC11 mnemonics.

When entering branch instructions, the number placed in the operand field should be the absolute destination address of the instruction. The assembler calculates the two's-complement offset of the branch and places the offset in memory with the instruction

The assembly/disassembly process may be terminated by entering a period (.) as the first non-space character following the assembler prompt.

restrictions:

None.

Table 3-2. M68HC11 to CPU12 Instruction Translation

| M68HC11 Mnemonic | CPU12 Instruction | M68HC11 Mnemonic | CPU12 Instruction |
|------------------|-------------------|--------------------------------------|--------------------------------------|
| CLC | ANCC # \$FE | INS | LEAS 1, S |
| CLI | ANCC # \$EF | TAP | TFR A, CC |
| CLV | ANCC # \$FD | TPA | TFR CC, A |
| SEC | ORCC # \$01 | TSX | TFR S, X |
| SEI | ORCC # \$10 | TSY | TFR S, Y |
| SEV | ORCC # \$02 | XGDX | EXG D, X |
| ABX | LEAX B, X | XGDY | EXG D, Y |
| ABY | LEAY B, Y | SEX R ₈ , R ₁₆ | TFR R ₈ , R ₁₆ |
| DES | LEAS -1, S | | |

example:

```
>ASM 800
0800 CC1000          LDD          #$1000
0803 1803123401FE   MOVW        #$1234,$01FE
0809 0EF9800001F1   BRSET      -32768,PC,$01,$0700
080F 18FF           TRAP        $FF
0811 183FE3         ETBL        <Illegal Addr Mode>  >_
>
```

assembly operand format:

This section describes the operand format used by the assembler when assembling CPU12 instructions. The operand format accepted by the assembler is described separately in the *CPU12 Reference Manual*. Rather than describe the numeric format accepted for each instruction, some general rules are used. Exceptions and complicated operand formats are described separately.

In general, anywhere the assembler expects a numeric value in the operand field, either a decimal or hexadecimal value may be entered. Decimal numbers are entered as signed constants having a range of -32768 to 65535. A leading minus sign (-) indicates negative numbers, the absence of a leading minus sign indicates a positive number. A leading plus sign (+) is not allowed.

Hexadecimal numbers must be entered with a leading dollar sign (\$) followed by one to four hexadecimal digits. The default number base is decimal.

For all branching instructions (Bcc, LBcc, BRSET, BRCLR, DBEQ, DBNE, IBEQ, IBNE, TBEQ, and TBNE), the number entered as the branch address portion of the operand field is the absolute address of the branch destination. The assembler calculates the two's-complement offset to be placed in the assembled object code.

disassembly operand format:

The operand format used by the disassembler is described separately in the *CPU12 Reference Manual*. Rather than describing the numeric format used for each instruction, some general rules are applied. Exceptions and complicated operand formats are described separately.

All numeric values disassembled as hexadecimal numbers are preceded by a dollar sign (\$) to avoid being confused with values disassembled as signed decimal numbers.

For all branch (Bcc, LBcc, BRSET, BRCLR, DBEQ, DBNE, IBEQ, IBNE, TBEQ, TBNE) instructions the numeric value of the address portion of the operand field is displayed as the hexadecimal absolute address of the branch destination.

All offsets used with indexed addressing modes are disassembled as signed decimal numbers.

All addresses, whether direct or extended, are disassembled as four digit hexadecimal numbers.

All 8-bit mask values (BRSET/BRCLR/ANDCC/ORCC) are disassembled as two-digit hexadecimal numbers.

All 8-bit immediate values are disassembled as hexadecimal numbers.

All 16-bit immediate values are disassembled as hexadecimal numbers.

BAUD**Set Baud Rate****BAUD****syntax:**

```
BAUD <BAUDRate>
```

where:

<BAUDRate> is an unsigned 16-bit decimal number.

The BAUD command is used to change the communications rate of the SCI used by D-Bug12 for the terminal interface.

restrictions:

Because the <BAUDRate> parameter supplied on the command line is a 16-bit unsigned integer, BAUD rates greater than 65535 baud cannot be set using this command. The SCI BAUD rate divider value for the requested BAUD rate is calculated using the E-clock value supplied in the D-Bug12 customization data area. Because the SCI BAUD rate divider is a 13-bit counter, certain BAUD rates may not be supported at particular E-clock frequencies. If the value calculated for the SCI's BAUD rate divider is equal to zero or greater than 8191, command execution is terminated and the communications BAUD rate is not changed.

example:

```
>BAUD 50  
Invalid BAUD Rate  
>BAUD 38400  
Change Terminal BR, Press Return  
>
```

BF**Block Fill****BF****syntax:**

```
BF <StartAddress> <EndAddress> [<Data>]
```

where:

<StartAddress> is a 16-bit hexadecimal number.

<EndAddress> is a 16-bit hexadecimal number.

<Data> is an 8-bit hexadecimal number.

The Block Fill command is used to place a single 8-bit value into a range of memory locations. <StartAddress> is the first memory location written with <data> and <EndAddress> is the last memory location written with <data>. If the <data> parameter is omitted, the memory range is filled with the value \$00.

restrictions:

None.

example:

```
>BF 6400 6fff 0  
-----  
>BF 6f00 6fff 55  
>
```

BR**Breakpoint Set****BR****syntax:**

```
BR [ <Address> <Address> ... ]
```

where:

<Address> are optional 16-bit hexadecimal numbers.

The BR command is used to set a software breakpoint at a specified address or to display any previously set breakpoints. The function of a breakpoint is to halt user program execution when the program reaches the breakpoint address. When a breakpoint address is encountered, D-Bug12 disassembles the instruction at the breakpoint address, prints the CPU12's register contents, and waits for a D-Bug12 command to be entered by the user.

Breakpoints are set by typing the breakpoint command followed by one or more breakpoint addresses. Entering the breakpoint command without any breakpoint addresses will display all the currently set breakpoints.

A maximum of 10 user breakpoints may be set at one time.

restrictions:

D-Bug12 implements the breakpoint function by replacing the opcode at the breakpoint address in the users program with an SWI instruction when operating in EVB mode or with the BGND instruction when operating in POD mode. A breakpoint may not be set on a user SWI instruction when operating in EVB mode. In either mode, breakpoints may only be set at an opcode address, and breakpoints may only be placed at memory addresses in alterable memory.

Even though D-Bug12 supports a maximum of 10 user-defined breakpoints, a maximum of 9 breakpoints may be set on the command line at one time. This restriction is due to the limitation of the command-line processor, which allows a maximum of 10 command-line arguments, including the command string.

When operating in POD mode, new breakpoints may not be set with the BR command when the "R>" prompt is displayed. However, the BR command may be used to display breakpoints that are currently set in the user's running program.

D-Bug12 version 2.0.0 does not support the MC68HC912B32's hardware breakpoint (H/W) function. Later versions of D-Bug12, which may support this function, can be obtained from the sources listed in **Obtaining D-Bug12 Upgrades** on page E-6.



example:

```
>BR 35ec 2f80 c592  
Breakpoints: 35EC 2F80 C592
```

```
>BR  
Breakpoints: 35EC 2F80 C592
```

```
>
```

BULK**Bulk Erase EEPROM****BULK****syntax:**

BULK

The BULK command is used to erase the entire contents of byte-erasable EEPROM in a single operation. After the bulk erase operation has been performed, each on-chip EEPROM location is checked for an erased condition.

restrictions:

In order to erase EEPROM, the EEPROM block-protect control bits must be cleared. Refer to the *MC68HC912B32 Technical Summary* for locations and operation of the block-protect controls.

example:

```
>BULK  
  
F/EEPROM Failed To Erase  
>BULK  
  
>
```

CALL**Call Subroutine****CALL****syntax:**

```
CALL [ <Address> ]
```

where:

<Address> is an optional 16-bit hexadecimal number.

The CALL command is used to execute a subroutine and return to the D-Bug12 monitor program when the final RTS of the subroutine is executed. When control is returned to D-Bug12, the CPU register contents are displayed. All CPU registers contain the values at the time the final RTS instruction was executed, with the exception of the program counter (PC). The PC contains the starting address of the subroutine. If a subroutine address is not supplied on the command line, the current value of the Program Counter (PC) is used as the starting address.

NOTE:

No user breakpoints are placed in memory before execution is transferred to user code.

restrictions:

If the called subroutine modifies the value of the stack pointer during its execution, it *must* restore the stack pointer's original value before executing the final RTS of the called subroutine. This restriction is required because a return address is placed on the users stack that returns to D-Bug12 when the final RTS of the subroutine is executed. Obviously, any subroutine must obey this restriction to execute properly.

The CALL command cannot be issued when the "R>" prompt is displayed, indicating that the target system is already running a user program.

example:

```
>CALL 820
Subroutine Call Returned

PC      SP      X      Y      D = A:B      CCR = SXHI  NZVC
0820   0A00   057C   0000      0F:F9      1001  0000
>
```

DEVICE

Specify Target MCU Device

DEVICE**syntax:**

DEVICE

```

DEVICE          <DeviceName> [ <EEStart> <EEEnd> <FStart>
                  <FEnd> <RAMStart> <RAMEnd> <IOBase> ]

```

where:

| | |
|--------------|---|
| <DeviceName> | is the maximum of 7 ASCII characters used to select/define a target MCU device. |
| <EEStart> | is the on-chip EEPROM starting address; a 16-bit hexadecimal number. |
| <EEEnd> | is the on-chip EEPROM ending address; a 16-bit hexadecimal number. |
| <FStart> | is the on-chip Flash EEPROM starting address; a 16-bit hexadecimal number. |
| <FEnd> | is the on-chip Flash EEPROM ending address; a 16-bit hexadecimal number. |
| <RAMStart> | is the on-chip RAM starting address; a 16-bit hexadecimal number. |
| <RAMEnd> | is the on-chip RAM ending address; a 16-bit hexadecimal number. |
| <IOBase> | is the base address of the on-chip I/O registers; a 16-bit hexadecimal number. |

Selecting the proper target MCU with the DEVICE command provides D-Bug12 the information necessary to allow transparent alteration of the target MCU's on-chip EEPROM using any D-Bug12 commands that modify memory. It also provides the necessary information to allow the programming and erasure of on-chip Flash EEPROM. In addition, it allows D-Bug12 to initialize the stack pointer to the top of on-chip RAM when the target MCU is reset by use of the RESET command. The DEVICE command has three separate command line formats that allows for the display, selection and/or definition of target device parameters.

Entering "DEVICE" on the command line followed by a carriage return displays the name of the currently selected device, the on-chip EEPROM's starting and ending address, the on-chip Flash EEPROM's starting and ending address, the on-chip RAM's starting and ending address, and the I/O Base address. This form of the command may be used when D-Bug12 is operating in either EVB or POD mode.

When D-Bug12 is operated in the POD mode, the DEVICE command may also be used to select or define a new target device. Entering the DEVICE command followed only by a device name

configures D-Bug12 for operation with the selected target device. The default device list contains entries for the MC68HC912B32 and the MC68HC812A4. The table below shows the command line name to use for the two default MCU devices.

| Device Name | Target MCU |
|-------------|--------------|
| 912B32 | MC68HC912B32 |
| 812A4 | MC68HC812A4 |

Entering the DEVICE command followed by a device name and seven hexadecimal parameters allows new devices to be added to the target device table or existing device table entries to be modified. When a new device is added or when an existing device entry is modified, it becomes the currently selected device. If a new device does not contain a particular on-chip resource, such as Flash EEPROM, a value of zero should be entered for the starting and ending addresses

Because the target device data and the current device selection are stored in the probe MCU's on-chip EEPROM, new device information and the device selection are retained when power is removed from the POD. If the M68EVB912B32 is operated in EVB mode and the contents of *any* locations of the on-chip EEPROM are altered it is *strongly* recommended that the on-chip EEPROM be completely erased by using the BULK command before using the EVB in POD mode again. Erasing the on-chip EEPROM causes D-Bug12 to reinitialize the device table with the two default MCU devices. The information for any new devices that were added to the table will be lost.

restrictions:

When operating the M68EVB912B32 in EVB mode, the DEVICE command may only be used to display the current device information.

The DEVICE command maintains a 16-bit checksum on the contents of the entire on-chip EEPROM to maintain the integrity of the device table. If any of the on-chip EEPROM locations are altered while operating the M68EVB912B32 in EVB mode, D-Bug12 will reinitialize the device table with the default device information contained in the on-chip Flash EEPROM. However, it is possible for the checksum verification to fail (one case where the checksum will fail is if the entire contents of the on-chip EEPROM is programmed with zeros). Therefore, it is *strongly* recommended that the on-chip EEPROM be completely erased by using the BULK command before using the EVB in POD mode again. Using the EVB in Probe mode with a corrupt device data table may cause D-Bug12 to operate in an unpredictable manner.

The 768 bytes of on-chip EEPROM allows a total of 34 entries in the device table. *Do not* exceed this number.

When adding a new device to the device table, the addresses provided for the on-chip Flash EEPROM, on-chip RAM and the I/O Registers should reflect the locations of these resources when the part is reset. This requirement is necessary for the FBULK and FLOAD commands to work properly.

**example:**

```
>DEVICE
```

```
Device: 912B32  
EEPROM: $0D00 - $0FFF  
Flash: $8000 - $FFFF  
RAM: $0800 - $0BFF  
I/O Regs: $0000
```

```
S>DEVICE 912b32 1d00 1fff 8000 ffff 800 bff 0
```

```
Device: 912B32  
EEPROM: $1D00 - $1FFF  
Flash: $8000 - $FFFF  
RAM: $0800 - $0BFF  
I/O Regs: $0000
```

```
S>DEVICE 812a4
```

```
Device: 812A4  
EEPROM: $1000 - $1FFF  
RAM: $0800 - $0BFF  
I/O Regs: $0000
```

```
S>
```

EEBASE**Specify Target EEPROM
Base Address****EEBASE****syntax:**

```
EEBASE          <Address>
```

where:

<Address> is an optional 16-bit hexadecimal number.

Each time D-Bug12 performs a memory write, it automatically performs the necessary register manipulations to program the on-chip EEPROM if the write operation falls within the address range of the target's on-chip EEPROM. Because user code may change the EEPROM's base address by writing to the INITEE register, D-Bug12 must be informed of the EEPROM's location if automatic EEPROM writes are to occur. The EEBASE command is used to specify the base address of the target processor's on-chip EEPROM.

When operating in EVB mode, the default EEPROM base address and range are specified in the customization data variables `CustomData.EEBase` and `CustomData.EESize`. The value in `CustomData.EEBase` is used by the startup code to remap the EEPROM. The EEBASE command may not be used to relocate the I/O registers.

When operating in POD mode, the target's default EEPROM base address and range are specified by the currently-selected device (See the DEVICE command for additional details).

The EEBASE command does *not* check to ensure that the parameter is a valid base address for the selected M68HC12 family member. If an improper base address is provided, automatic programming of the on-chip EEPROM will not operate properly.

NOTE

The EEBASE command does not automatically modify the INITEE register. It is the responsibility of the user to ensure that the INITEE register is modified either manually or through the execution of user code.

restrictions:

The EEBASE command may not be used when D-Bug12 is operated in EVB mode.

example:

```
S><DEVICE
```

```
Device: 912B32
EEPROM: $0D00 - $0FFF
Flash: $8000 - $FFFF
RAM: $0800 - $0BFF
I/O Regs: $0000
```

```
S><EEBASE 1d00
```

```
Device: 912B32
EEPROM: $1D00 - $1FFF
Flash: $8000 - $FFFF
RAM: $0800 - $0BFF
I/O Regs: $0000
```

```
S><MM 12
0012 01 11
0013 0F .
S><MD 1d00
```

```
1D00 FF FF FF FF - FF FF FF FF - FF FF FF FF - FF FF FF FF .....
S>
```

FBULK**Erase Target Flash
EEPROM****FBULK****syntax:**

FBULK

The FBULK command is used to erase the entire contents of the target MCU's on-chip Flash EEPROM in a single operation. After the bulk erase operation has been performed, each on-chip Flash location is verified. If the contents are not \$FF, an error message is displayed.

The target processor's Flash EEPROM is erased by resetting the target processor and then loading a small driver program into the target processor's on-chip RAM. For this reason, the previous contents of the target processor's on-chip RAM are lost.

restrictions:

When operating in the EVB mode, the FBULK command cannot be used. If the FBULK command is entered while in EVB mode, an error message is displayed and command execution is terminated.

Before using the FBULK command, a target device must have been selected with the DEVICE command that reflects the locations of the target's on-chip Flash EEPROM, on-chip RAM, and the I/O registers when the part is reset. Failure to follow this restriction will cause the FBULK command to fail and may require that the EVB be reset.

Flash EEPROM programming voltage (V_{pp}) must be applied to the target MCU. If the target system is another M68EVB912B32 board, V_{pp} may be supplied via header W8, with header W7 set accordingly. For more information on these EVB headers, see Table 4-1.

Because the FBULK command downloads a small "driver" program into the target MCU's on-chip RAM, D-Bug12's breakpoint table is cleared before beginning execution of the "driver". This is necessary to prevent previously-set breakpoints from accidentally halting the execution of the driver program.

**example:**

```
S>>FBULK
Flash Programming Voltage Not Present
S>>FBULK
F/EEPROM Failed To Erase
S>>FBULK
S>
```

```
>FBULK
Command Not Allowed In EVB Mode
>
```

FLOAD**Program Target Flash
EEPROM****FLOAD****syntax:**

```
FLOAD [<AddressOffset>]
```

where:

<AddressOffset> is a 16-bit hexadecimal number.

The FLOAD command is used to program a target device's Flash EEPROM memory with the data contained in S-Record object files. The address offset, if supplied, is added to the load address of each S-Record before the S-Record's data bytes are placed in memory. Providing an address offset other than zero allows object code or data to be programmed into memory at a location other than that for which it was assembled or compiled.

The programming of the on-chip Flash EEPROM uses an algorithm where the time required to program each byte or word can vary from as little as 60 μ S to as long as 3.5 mS (note, however that the programming time for each byte or word should typically take no more than 120-180 μ S). Because of this variability, the FLOAD command uses a software handshaking protocol to control the flow of S-Record data from the host computer. When the FLOAD command is ready to receive an S-Record, an ASCII asterisk character (*) is sent to the host computer. The host computer should respond by sending a single S-Record. The S-Record may include a carriage return and/or line feed character(s). Most commercial terminal programs that are capable of sending ASCII text files have the ability to wait for a specific character or characters before sending a line of text.

The FLOAD command is terminated when D-Bug12 receives an "S9" end-of-file record. If the object file being loaded does not contain an "S9" record, D-Bug12 does not return its prompt and continues to wait for the end-of-file record. Pressing the reset switch returns D-Bug12 to its command line prompt.

restrictions:

The host program used to send the S-Record data must be capable of waiting for an ASCII asterisk character (*) before sending each S-Record line.

Because the on-chip Flash EEPROM is only bulk-erasable, the FBULK command should be used before loading new data into Flash EEPROM with the FLOAD command.

The FLOAD command cannot be used with S-Records that contain a code/data field longer than 64 bytes. Sending an S-Record with a longer field may cause D-Bug12 to crash or load incorrect data into the Flash EEPROM.

Before using the FLOAD command, a target device must have been selected using the DEVICE command that reflects the locations of the on-chip Flash EEPROM, on-chip RAM, and the I/O registers when the part is reset. Failure to follow this restriction will cause the FLOAD command to fail and may require that the EVB be reset.

Flash EEPROM programming voltage (Vpp) must be applied to the target MCU. If the target system is another M68EVB912B32 board, Vpp may be supplied via header W8, with header W7 set accordingly. For more information on these EVB headers, see Table 4-1.

Because the FLOAD command downloads a small "driver" program into the target MCU's on-chip RAM, D-Bug12's breakpoint table is cleared before beginning execution of the "driver". This is necessary to prevent previously set breakpoints from accidentally halting the execution of the driver program.

example:

```
S>FLOAD
Flash Programming Voltage Not Present
S>FLOAD
*****
*****
*****
S>
```

G**Go Execute a User Program****G****syntax:**

```
G [<Address>]
```

where:

<Address> is an optional 16-bit hexadecimal number.

The G command is used to begin the execution of user code in real time. Before beginning execution of user code, any breakpoints that were set with the BR command are placed in memory. Execution of the user program continues until a user breakpoint is encountered, a CPU exception occurs, the STOP or RESET command is entered, or the EVB's reset switch is pressed.

When user code halts for any of these reasons (except reset, which wipes the slate clean) and control is returned to D-Bug12, a message is displayed explaining the reason for user program termination. In addition, D-Bug12 disassembles the instruction at the current PC address, prints the CPU12's register contents, and waits for the next D-Bug12 command to be entered by the user.

If a starting address is not supplied in the command line parameter, program execution will begin at the address defined by the current value of the Program Counter.

restrictions:

The G command cannot be issued when the "R>" prompt is displayed, indicating that the target system is already running a user program.

example:

```
S>G 800
R>MD 1000

1000 FF FF FF FF - FF FF FF FF - FF FF FF FF - FF FF FF FF .....
R>
User Breakpoint Encountered

  PC    SP    X    Y    D = A:B    CCR = SXHI NZVC
0820 09FE 057C 0000    00:00        1001 0100
0820 08             INX
S>
```

GT**Go Till****GT****syntax:**

```
GT <Address>
```

where:

<Address> is a 16-bit hexadecimal number.

The GT command is similar to the G command except that a temporary breakpoint is placed at the address supplied on the command line. Any breakpoints that were set by the use of the BR command are NOT placed in the user code before program execution begins. Program execution begins at the address defined by the current value of the Program Counter. When user code reaches the temporary breakpoint and control is returned to D-Bug12, a message is displayed explaining the reason for user program termination. In addition, D-Bug12 disassembles the instruction at the current PC address, prints the CPU12's register contents, and waits for a command to be entered by the user.

restrictions:

The GT command cannot be issued when the "R>" prompt is displayed, indicating that the target system is already running a user program.

example:

```
S>GT 820
R>
Temporary Breakpoint Encountered

  PC      SP      X      Y      D = A:B      CCR = SXHI NZVC
0820  09FE  057C  0000      00:00      1001 0100
0820  08                INX
S>
```



HELP

Onscreen Help Summary

HELP

syntax:

HELP

The HELP command is used to display a summary of the D-Bug12 command set. Each command is shown along with its command line format and a brief description of its function.

restrictions:

None.

example:

```

>HELP
ASM <Address>  Single line assembler/disassembler
  <CR>         Disassemble next instruction
  <.>         Exit assembly/disassembly
BAUD <baudrate> Set communications rate for the terminal
BF <StartAddress> <EndAddress> [<data>] Fill memory with data
BR [<Address>] Set/Display user breakpoints
BULK Erase entire on-chip EEPROM contents
CALL [<Address>] Call user subroutine at <Address>
DEVICE [<DevName> [<Address>...<Address>]] display/select/add
target device
EEBASE <Address> Set base address of on-chip EEPROM
FBULK Erase entire target Flash contents
FLOAD [<AddressOffset>] Load S-Records into target Flash
G [<Address>] Begin/continue execution of user code
GT <Address> Set temporary breakpoint at <Address> & execute
user code
HELP Display this D-Bug12 command summary
LOAD [<AddressOffset>] Load S-Records into memory
MD <StartAddress> [<EndAddress>] Memory Display Bytes
MDW <StartAddress> [<EndAddress>] Memory Display Words
MM <StartAddress> Modify Memory Bytes
  <CR>           Examine/Modify next location
  </> or <=>    Examine/Modify same location
  <^> or <->    Examine/Modify previous location
  <.>           Exit Modify Memory command
MMW <StartAddress> Modify Memory Words (same subcommands as MM)
MOVE <StartAddress> <EndAddress> <DestAddress> Move a block of
memory
NOBR [<address>] Remove One/All Breakpoint(s)
RD Display all CPU registers
REGBASE <Address> Set base address of I/O registers
RESET Reset target CPU
RM Modify CPU Register Contents
STOP Stop target CPU
T [<count>] Trace <count> instructions
UPLOAD <StartAddress> <EndAddress> S-Record Memory display
VERF [<AddressOffset>] Verify S-Records against memory contents
<Register Name> <Register Value> Set register contents
  Register Names: PC, SP, X, Y, A, B, D
  CCR Status Bits: S, XM, H, IM, N, Z, V, C
>

```

LOAD**Load S-Record File****LOAD****syntax:**

```
LOAD [<AddressOffset>]
     {Send File}
```

where:

<AddressOffset> is an optional 16-bit hexadecimal number.

{*Send File*} is the host-computer communications program's utility for sending an ASCII (text) file. Refer to **Appendix B — Communications Program Examples**.

The LOAD command is used to load S-Record object files into memory from an external device. The address offset, if supplied, is added to the load address of each S-Record before its data bytes are placed in memory. Providing an address offset other than zero allows object code or data to be loaded into memory at a location other than that for which it was assembled. During the loading process, the S-Record data is not echoed to the control console. However, for each ten S-Records that are successfully loaded, an ASCII asterisk character (*) is sent to the control console. When an S-Record file has been successfully loaded, control returns to the D-Bug12 prompt.

The LOAD command is terminated when D-Bug12 receives an S9 end-of-file record. If the object file being loaded does not contain an S9 record, D-Bug12 does not return its prompt and continues to wait for the end-of-file record. Pressing the reset switch returns D-Bug12 to its command line prompt.

restrictions:

When operating in POD mode, the LOAD command does not support standard baud rates above 38400. This is due to the overhead involved in the implementation of the custom serial protocol required by the single-wire Background Debug Mode interface.

example:

```
>LOAD 1000
*****
>
```

MD**Memory Display****MD****syntax:**

```
MD <StartAddress> [ <EndAddress> ]
```

where:

<StartAddress> is a 16-bit hexadecimal number.

<EndAddress> is an optional 16-bit hexadecimal number.

The Memory Display command displays the contents of memory as both hexadecimal bytes and ASCII characters, 16-bytes on each line. The <StartAddress> parameter must be supplied; the <EndAddress> parameter is optional. When the <EndAddress> parameter is not supplied, a single line is displayed.

The number supplied as the <StartAddress> parameter is rounded down to the next lower multiple of 16, while the number supplied as the <EndAddress> parameter is rounded up to the next higher multiple of 16 - 1. This causes each line to display memory in the range of \$xxx0 through \$xxxF. For example, if \$205 is entered as the start address and \$217 as the ending address, the actual memory range displayed would be \$200 through \$21F.

restrictions:

None.

example:

```
>MD 800
0800 AA 04 37 6A - 00 06 27 F9 - 35 AE 78 0D - B7 56 78 20 ..7j...'5.x..Vx

>MD 800 87f
0800 AA 04 37 6A - 00 06 27 F9 - 35 AE 78 0D - B7 56 78 20 ..7j...'5.x..Vx
0810 B6 36 27 F9 - 35 AE 27 F9 - 35 9E 27 F9 - 35 BE B5 28 .6'.5.'.5.'.5..(
0820 27 F9 35 D6 - 37 B8 00 0F - 37 82 01 0A - 37 36 FF F0 '.5.7...7...76..
0830 7C 10 37 B3 - 00 00 37 B6 - 00 0F AA 04 - A5 02 37 B6 |.7...7.....7.
0840 00 0F 27 78 - 37 6A 00 06 - 27 F9 35 78 - 27 F9 35 56 ..'x7j...'5x'.5V
0850 78 0D B7 10 - 78 3B 37 86 - 00 DC 27 F9 - 35 48 78 57 x...xi7...'5HxW
0860 37 86 00 DE - F5 01 EA 09 - 37 B5 0D 0A - 27 F9 36 2A 7.....7...'6*
0870 A5 00 37 65 - 00 02 27 F9 - 35 E8 37 9C - 37 4C F5 02 ..7e...'5.7.7L..
>
```

MDW**Memory Display, Word****MDW****syntax:**

```
MDW <StartAddress> [<EndAddress>]
```

where:

<StartAddress> is a 16-bit hexadecimal number.

<EndAddress> is an optional 16-bit hexadecimal number.

The Memory Display Word command displays the contents of memory as hexadecimal words and ASCII characters, 16-bytes on each line. The <StartAddress> parameter must be supplied; the <EndAddress> parameter is optional. When the <EndAddress> parameter is not supplied, a single line is displayed.

The number supplied as the <StartAddress> parameter is rounded down to the next lower multiple of 16, while the number supplied as the <EndAddress> parameter is rounded up to the next higher multiple of 16 - 1. This causes each line to display memory in the range of \$xxx0 through \$xxxF. For example, if \$205 is entered as the start address and \$217 as the ending address, the actual memory range displayed would be \$200 through \$21F.

restrictions:

None.

example:

```
>MDW 800
0800 AA04 376A - 0006 27F9 - 35AE 780D - B756 7820 ..7j..'5.x..Vx

>MDW 800 87f
0800 AA04 376A - 0006 27F9 - 35AE 780D - B756 7820 ..7j..'5.x..Vx
0810 B636 27F9 - 35AE 27F9 - 359E 27F9 - 35BE B528 .6'.5.'.5.'.5..(
0820 27F9 35D6 - 37B8 000F - 3782 010A - 3736 FFF0 '.5.7...7...76..
0830 7C10 37B3 - 0000 37B6 - 000F AA04 - A502 37B6 |.7...7.....7.
0840 000F 2778 - 376A 0006 - 27F9 3578 - 27F9 3556 ..'x7j..'5x'.5V
0850 780D B710 - 783B 3786 - 00DC 27F9 - 3548 7857 x...xi7...'5HxW
0860 3786 00DE - F501 EA09 - 37B5 0D0A - 27F9 362A 7.....7...'6*
0870 A500 3765 - 0002 27F9 - 35E8 379C - 374C F502 ..7e..'5.7.7L..
>
```

MM**Memory Modify****MM****syntax:**

```
MM <Address> [ <Data> ]
```

where:

<Address> is a 16-bit hexadecimal number.
<Data> is an optional 8-bit hexadecimal number.

The Memory Modify command allows the contents of memory to be examined and/or modified as 8-bit hexadecimal data. If the 8-bit data parameter is present on the command line, the byte at memory location <Address> is replaced with <Data> and the command is terminated. If not, D-Bug12 enters the interactive memory modify mode. In the interactive mode, each byte is displayed on a separate line following the data's address. Once the memory modify command has been entered, single-character sub-commands are used for the modification and verification of memory contents. These sub-commands have the following format:

[<Data>] <CR> Optionally update current location and display the next location.
[<Data>] </> or <=> Optionally update current location and redisplay the current location.
[<Data>] <^> or <-> Optionally update current location and display the previous location.
[<Data>] <.> Optionally update current location and exit Memory Modify.

With the exception of the carriage return, the sub-command must be separated from any entered data with at least one space character. If an invalid sub-command character is entered, an appropriate error message is issued and the contents of the current memory location are redisplayed.

restrictions:

While there are no restrictions on the use of the MM command, caution should be used when modifying target memory while user code is running. Accidentally modifying target memory containing program code could lead to program runaway.



example:

```
>MM 800
0800 00 <CR>
0801 F0 FF
0802 00 ^
0801 FF <CR>
0802 00 <CR>
0803 08 55 /
0803 55 .
>
```

MMW**Memory Modify, Word****MMW****syntax:**

```
MMW <Address> [ <Data> ]
```

where:

<Address> is a 16-bit hexadecimal number.
<Data> is an optional 16-bit hexadecimal number.

The Memory Modify Word command allows the contents of memory to be examined and/or modified as 16-bit hexadecimal data. If the 16-bit data parameter is present on the command line, the word at memory location <Address> is replaced with <Data> and the command is terminated. If not, D-Bug12 enters the interactive memory modify mode. In the interactive mode, each word is displayed on a separate line following the data's address. Once the memory modify command has been entered, single-character sub-commands are used for the modification and verification of memory contents. These sub-commands have the following format:

[<Data>] <CR> Optionally update current location and display the next location.
[<Data>] </> or <=> Optionally update current location and redisplay the current location.
[<Data>] <^> or <-> Optionally update current location and display the previous location.
[<Data>] <.> Optionally update current location and exit Memory Modify.

With the exception of the carriage return, the sub-command must be separated from any entered data with at least one space character. If an invalid sub-command character is entered, an appropriate error message is issued and the contents of the current memory location are redisplayed.

restrictions:

While there are no restrictions on the use of the MMW command, caution should be used when modifying target memory while user code is running. Accidentally modifying target memory containing program code could lead to program runaway.



example:

```
>MMW 800
0800 00F0 <CR>
0802 0008 AA55 /
0804 843F ^
0802 AA55 <CR>
0804 843F <CR>
0806 C000 .
>
```

MOVE**Move Memory Block****MOVE****syntax:**

```
MOVE <StartAddress> <EndAddress> <DestAddress>
```

where:

<StartAddress> is a 16-bit hexadecimal number.

<EndAddress> is a 16-bit hexadecimal number.

<DestAddress> is a 16-bit hexadecimal number.

The MOVE command is used to move a block of memory from one location to another, one byte at a time. The number of bytes moved is one more than the <EndAddress> - <StartAddress>. The block of memory beginning at the destination address may overlap the memory block defined by the <StartAddress> and <EndAddress>.

One of the uses of the MOVE command might be to copy a program from RAM into the on-chip EEPROM memory.

restrictions:

A minimum of one byte may be moved if the <StartAddress> is equal to the <EndAddress>. The maximum number of bytes that may be moved is $2^{16} - 1$.

Caution should be exercised when moving target memory while user code is running. Accidentally modifying target memory containing program code could lead to program runaway.

example:

```
>MOVE 800 8ff 1000  
>
```

NOBR**Remove Breakpoints****NOBR****syntax:**

```
NOBR [<Address> <Address> ...]
```

where:

<Address> is an optional 16-bit hexadecimal number.

The NOBR command can be used to remove one or more previously entered breakpoints. If the NOBR command is entered without any arguments, all user breakpoints are removed from the breakpoint table.

restrictions:

When operating in the POD mode, breakpoints may not be removed with the NOBR command when the "R>" prompt is displayed.

example:

```
>BR 800 810 820 830  
Breakpoints: 0800 0810 0820 0830
```

```
>NOBR 810 820  
Breakpoints: 0800 0830
```

```
>NOBR  
All Breakpoints Removed
```

```
>
```

RD**Register Display****RD****syntax:**

RD

The Register Display command is used to display the CPU12's registers.

restrictions:

When operating in POD mode, the CPU registers may not be displayed when the "R>" prompt is displayed.

example:

```
>RD
 PC      SP      X      Y      D = A:B      CCR = SXHI NZVC
0206    03FF    1000    3700      27:FF          1001 0001
>
```

REGBASE

Specify Target EEPROM
Register Address

REGBASE**syntax:**

```
REGBASE <Address>
```

where:

<Address> is a 16-bit hexadecimal number.

Because D-Bug12 supports the ability to transparently program the on-chip EEPROM of the target MCU, it must know the base address of the I/O registers. Because user code may change the register block's base address by writing to the INITRG register, D-Bug12 must be informed of the register block's base address for transparent EEPROM writes to occur. The REGBASE command is used to specify the base address of the target processor's on-chip registers.

The REGBASE command does not check to ensure that the <Address> parameter is a valid base address for the selected M68HC12 family member. If an improper register base address is provided, automatic programming of the on-chip EEPROM will not operate properly.

When operating in EVB mode, the default register base address is specified in the customization data variable `CustomData.IOBase`. This value is used by the startup code to remap the I/O registers. The REGBASE command may not be used to relocate the I/O registers.

NOTE

The REGBASE command does not automatically modify the INITRG register. It is the responsibility of the user to ensure that the INITRG register is modified either manually or through the execution of user code.

restrictions:

The REGBASE command may not be used when D-Bug12 is operated in the EVB mode.

example:

```
S>>DEVICE
```

```
Device: 912B32  
EEPROM: $0D00 - $0FFF  
Flash: $8000 - $FFFF  
RAM: $0800 - $0BFF  
I/O Regs: $0000
```

```
S>>REGBASE 2000
```

```
Device: 912B32  
EEPROM: $0D00 - $0FFF  
Flash: $8000 - $FFFF  
RAM: $0800 - $0BFF  
I/O Regs: $2000
```

```
S>
```

RESET

Reset Target MCU

RESET

syntax:

```
RESET
```

The RESET command is used to reset the target system processor when operating in D-Bug12's POD mode. The target processor's reset pin is held byte-erasable for approximately 2 mS. When the reset line is released, BDM commands are sent to the target processor to place it in active background mode. The target processor's registers are initialized with the same values used for the registers when operating in EVB mode.

The effects of the RESET command may be different from a user assertion of the target's RESET* pin:

- When the RESET command is issued, the host EVB controls the state of the target's BKGD pin, placing the target processor in Special mode and active background execution.
- When a user assertion of the target's RESET* pin occurs, the target processor may enter either Special or Normal mode, depending on the state of its BKGD pin. D-Bug12 displays a message indicating that the target processor has been reset.

restrictions:

When operating in the EVB mode, the RESET command cannot be used. If the RESET command is entered while in EVB mode, an error message is displayed and command execution is terminated.

example:

```
S>>RESET
Target Processor Has Been Reset
S>>G 4000
R>>RESET
Target Processor Has Been Reset
S>
```

RM**Register Modify****RM****syntax:**

RM

The Register Modify command is used to examine and/or modify the contents of the CPU12's registers in an interactive manner. As each register and its contents is displayed, D-Bug12 allows the user to enter a new value for the register in hexadecimal. If modification of the displayed register is not desired, entering a carriage return will cause the next CPU12 register and its contents to be displayed on the next line. When the last of the CPU12's registers has been examined and/or modified, the RM command displays the first register, giving the user an opportunity to make additional modifications to the CPU12's register contents. Typing a period (.) as the first non space character on the line will exit the interactive mode of the register modify command and return to the D-Bug12 prompt. The registers are displayed in the following order, one register per line: PC, SP, X, Y, A, B, CCR.

restrictions:

When operating in POD mode, the CPU registers may not be modified when the "R>" prompt is displayed.

example:

```
>RM
PC=0206 200
SP=03FF <CR>
X=1000 1004
Y=3700 <CR>
A=27 <CR>
B=FF <CR>
CCR=D0 D1
PC=0200 .
>
```

STOP**Stop Execution on Target
MCU****STOP****syntax:**

```
STOP
```

When operating in D-Bug12's POD mode, the STOP command is used to halt target program execution and place the target processor in active Background Debug Mode.

restrictions:

When operating in the EVB mode, the STOP command cannot be used. If the STOP command is entered while in EVB mode, an error message is displayed and command execution is terminated.

example:

```
S>ASM 4000
4000 CCFFFF          LDD    #$FFFF
4003 830001          SUBD   #$0001
4006 26FB           BNE    $4003
4008 20F6           BRA    $4000
400A 00             BGND
S>G 4000
R>STOP
Target Processor Has Been Stopped

   PC    SP    X    Y    D = A:B    CCR = SXHI NZVC
4003 0A00 0000 0000    37:3F    1101 0000
4003 830001          SUBD   #$0001
S>
```

T**Trace****T****syntax:**

```
T [<Count>]
```

where:

<Count> is an optional 8-bit decimal number in the range 1 to 255.

The Trace command is used to execute one or more user program instructions beginning at the current Program Counter (PC) location. As each program instruction is executed, the CPU12's register contents are displayed and the *next* instruction to be executed is displayed. A single instruction may be executed by entering the trace command immediately followed by a carriage return.

restrictions:

Because of the method used to execute a single instruction, branch instructions (Bcc, LBcc, BRSET, BRCLR, DBEQ/NE, IBEQ/NE, TBEQ/NE) that contain an offset that branches back to the instruction opcode DO NOT execute. D-Bug12 appears to become stuck at the branch instruction and does not execute the instruction even if the condition for the branch instruction is satisfied. This limitation can be overcome by using the GT (Go Till) command to set a temporary breakpoint at the instruction following the branch instruction.

In EVB mode, the Trace command may only be used for code located in alterable memory.

These restrictions *do not* apply when using D-Bug12 on a target system in POD mode.

example:

>T

| PC | SP | X | Y | D=A:B | CCR= | SXHI | NZVC |
|------|--------|------|------|---------|------|------|------|
| 0803 | 09FE | 057C | 0000 | 10:00 | | 1001 | 0000 |
| 0803 | 830001 | | SUBD | #\$0001 | | | |

>T 3

| PC | SP | X | Y | D=A:B | CCR= | SXHI | NZVC |
|------|------|------|------|--------|------|------|------|
| 0806 | 09FE | 057C | 0000 | 0F:FF | | 1001 | 0000 |
| 0806 | 26FB | | BNE | \$0803 | | | |

| PC | SP | X | Y | D=A:B | CCR= | SXHI | NZVC |
|------|--------|------|------|---------|------|------|------|
| 0803 | 09FE | 057C | 0000 | 0F:FF | | 1001 | 0000 |
| 0803 | 830001 | | SUBD | #\$0001 | | | |

| PC | SP | X | Y | D=A:B | CCR= | SXHI | NZVC |
|------|------|------|------|--------|------|------|------|
| 0806 | 09FE | 057C | 0000 | 0F:FE | | 1001 | 0000 |
| 0806 | 26FB | | BNE | \$0803 | | | |

>

UPLOAD**Display Memory in S-Record Format****UPLOAD****syntax:**

```
UPLOAD <StartAddress> <EndAddress>
```

where:

<StartAddress> is a 16-bit hexadecimal number.

<EndAddress> is a 16-bit hexadecimal number.

The **UPLOAD** command is used to display the contents of memory in Motorola S-Record format. In addition to displaying the specified range of memory, the **UPLOAD** command also outputs an **S9** end-of-file record. The output of this command may be captured by the users terminal program and saved to a disk file.

restrictions:

None.

example:

```
>UPLOAD 400 5ff
S123040000F0000843FC0000F50F379F37BF43FCF50F27FA757F177AFA047504177AFA21C5
S123042037B500FF37FAFB0437B5400037FAFB061735FB0037B500C137FAFA003715379C01
S1230440F50F379D37BC012C37BD400085009A003C023D02377C0140B6EE7A0F400037B583
S1230460000337FAFA4C37FAFA5037FAFA5437B5502037FAFA4E37B5302037FAFA5237B58A
S1230480682037FAFA5637BD014037BC000095008A003C023D02377D0172B6EE37BD017259
S12304A037BC020095008A003C023D02377D018EB6EE27F937B0F50F379C37BC00CE27F901
S12304C000FC27F9104C27F90E68378000BE0A0D442D42756731362056312E3033202D20E3
S12304E04465627567204D6F6E69746F7220466F7220546865204D363848433136204661ED
S12305006D696C790A0D2843292031393932204D6F746F726F6C612053656D69636F6E64BD
S12305207563746F7220496E632E000037B5FF0237FAFA4837B578B037FAFA4A7A0F005E52
S12305400000000000000000020002040208020C0210000000000000000000000002144F
S1230560000000000000000000000000000000000000000000000002187A0F3BAC7A0F3BBC7A0F11E87A0F62
S12305803C727A0F3C847A0F3C967A0F3CA8F50F379C379D379E27FAF50F379F37BF43FCE8
S12305A07501177A4054173540523604361C27F90088B0D637BC01BC360227F70A0D3E00A9
S12305C04500B70427F936BC3C01B0F027F7277537BC400017BC405027F936CC780DB60477
S12305E027F936A0274A27F77803B6FEB03A7808B6162776B7DE3730000127F93686752002
S9030000FC
>
```

VERF**Verify S-Record File against Memory****VERF****syntax:**

```
VERF  [<AddressOffset>]  
{Send File}
```

where:

<AddressOffset> is an optional 16-bit hexadecimal number.

{*Send File*} is the host-computer communications program's utility for sending an ASCII (text) file. Refer to **Appendix B — Communications Program Examples**.

The VERF command is used to compare the data contained in an S-Record object file to the contents of EVB memory. The address offset, if supplied, is added to the load address of each S-Record before an S-Record's data bytes are compared to the contents of memory. Providing an address offset other than zero allows the S-Record's object code or data to be compared against memory other than that for which the S-Record was assembled.

During the verification process, an ASCII asterisk character (*) is sent to the control console for each ten S-Records that are successfully verified. When an S-Record file has been successfully verified, control returns to the D-Bug12 prompt.

If the contents of EVB memory do not match the corresponding data in the received S-Records, an error message is displayed and the Verify command is terminated. D-Bug12 then returns to its command-line prompt. If the host computer continues to send S-Records to the EVB, D-Bug12 tries to interpret each S-Record as a command and issues error message for each S-Record received.

If the contents of EVB memory match the contents of the received S-Records, the Verify command terminates when D-Bug12 receives an S9 end-of-file record. If the object file being verified does not contain an S9 record, D-Bug12 continues to wait for an S9 record without returning to the command-line prompt. Pressing the reset switch, S1, returns D-Bug12 to its command-line prompt.

restrictions:

None.

example:

```
>VERF 1000  
*****  
>
```

<Register Name> Modify Register Value <Register Name>

syntax:

<RegisterName> <RegisterValue>

where:

<RegisterName> is one of the CPU12 registers listed in Table 3-3.

<RegisterValue> is an 8- or 16-bit hexadecimal number.

Table 3-3. CPU12 Registers

| Register Name | Description | Legal Range |
|----------------------|-------------------------|--------------------|
| PC | Program Counter | \$0 to \$FFFF |
| SP | Stack Pointer | \$0 to \$FFFF |
| X | X-Index Register | \$0 to \$FFFF |
| Y | Y-Index Register | \$0 to \$FFFF |
| A | A Accumulator | \$0 to \$FF |
| B | B Accumulator | \$0 to \$FF |
| D | D Accumulator (A:B) | \$0 to \$FFFF |
| CCR | Condition Code Register | \$0 to \$FF |

Each of the fields in the Condition Code Register (CCR) may be modified by using the bit names in Table 3-4.

Table 3-4. Condition Code Register Bits

| CCR Bit Name | Description | Legal Values |
|---------------------|--------------------|---------------------|
| S | STOP Enable | 0 or 1 |
| H | Half Carry | 0 or 1 |
| N | Negative Flag | 0 or 1 |
| Z | Zero Flag | 0 or 1 |

Table 3-4. Condition Code Register Bits (continued)

| CCR Bit Name | Description | Legal Values |
|--------------|--------------------------------|--------------|
| V | Two's Complement Overflow Flag | 0 or 1 |
| C | Carry Flag | 0 or 1 |
| IM | IRQ Interrupt Mask | 0 or 1 |
| XM | XIRQ Interrupt Mask | 0 or 1 |

This set of "commands" uses a CPU12 register name as the command name to allow changing the register's contents. Each register name or CCR bit name is entered on the command line followed by a space, then followed by the new register or bit contents. After successful alteration of a CPU register or CCR bit, the entire CPU register set is displayed.

restrictions:

None.

example:

```
>PC 700e
PC      SP      X      Y      D=A:B  CCR= SXHI  NZVC
700E   0A00   7315   7D62   47:44   1001      0000
>X 1000
PC      SP      X      Y      D=A:B  CCR= SXHI  NZVC
700E   0A00   1000   7D62   47:44   1001      0000
>C 1
PC      SP      X      Y      D=A:B  CCR= SXHI  NZVC
700E   0A00   1000   7D62   47:44   1001      0001
>Z 1
PC      SP      X      Y      D=A:B  CCR= SXHI  NZVC
700E   0A00   1000   7D62   47:44   1001      0101
>D adf7
PC      SP      X      Y      D=A:B  CCR= SXHI  NZVC
700E   0A00   1000   7D62   AD:F7   1001      0101
>
```

3.7 OFF-BOARD CODE GENERATION

Code developed outside the EVB environment should be generated with an M68HC12-compatible assembler or C compiler that can generate object files in S-Record format. The recommended assembler, P&E Microcomputer Systems' IASM12, is supplied with the EVB package on the diskette labeled "IASM12." The IASM12 user's manual, IASM12.DOC, is also on the diskette.

S-Records are described in **Appendix A — S-Record Format**.

When the S-Record file has been generated, it may be loaded from the host computer into EVB memory in the following ways:

- into the host EVB's byte-erasable EEPROM or RAM, using the D-Bug12 commands BULK and LOAD when the host EVB is in **EVB mode**
- into the host EVB's byte-erasable or Flash EEPROM, using the EEPROM bootloader when the host EVB is in **BOOTLOAD mode**
- into a target MCU's byte-erasable EEPROM or RAM, using the D-Bug12 commands BULK and LOAD when the host EVB is in **POD mode**
- into a target MCU's Flash EEPROM, using the D-Bug12 commands FBULK and FLOAD when the host EVB is in **POD mode**

More information on the EVB operating modes, the D-Bug12 commands, and the EEPROM bootloader can be found in section 3.1, section 3.2.2, section 3.6, and **Appendix E**.

3.8 MEMORY USAGE

3.8.1 Description

The EVB's memory usage and requirements are described below and summarized in Table 3-5.

The monitor program, D-Bug12, occupies the 32 Kbyte Flash EEPROM area of the MCU's memory map. To use the Flash EEPROM area for custom programs, refer to **Appendix E EEPROM Bootloader**.

When operating in EVB mode, D-Bug12 requires 512 bytes of on-chip RAM, from \$0A00 to \$0BFF, for stack and variable storage. The remaining 512 bytes of on-chip RAM, from \$0800 to \$09FF, are available for variable storage and stack space by user programs.

NOTE

D-Bug12 sets the default value of the user's stack pointer to \$0A00. This is not a mistake. The M68HC12's stack pointer points to the last byte that was pushed onto the stack, rather than to the next available byte on the stack, as the M68HC11 does. The M68HC12 first decrements its stack pointer, then stores data on the stack. The M68HC11 stores data on the stack and then decrements its stack pointer.

3.8.2 Memory Map

Table 3-5. Factory-Configuration Memory Map

| Address Range | Usage | Description |
|--|---|-----------------------------------|
| \$0000 - \$01FF | CPU registers | on-chip registers |
| \$0800 - \$09FF \$0A00 - \$0BFF | user code/data reserved for D-Bug12 | 1K on-chip RAM |
| \$0D00 - \$0FFF | user code/data | 768 bytes on-chip EEPROM |
| \$8000 - \$F67F \$F680 - \$F6BF \$F6C0 - \$F6FF \$F700 - \$F77F \$F780 - \$F7FF \$F800 - \$FBFF \$FC00 - \$FFBF \$FFC0 - \$FFFF | D-Bug12 code user-accessible functions D-Bug12 customization data D-Bug12 startup code interrupt vector jump table reserved for bootloader expansion EEPROM bootloader reset and interrupt vectors | 32 Kbytes on-chip Flash EEPROM |

3.9 OPERATIONAL LIMITATIONS

In EVB mode, D-Bug12 requires many of the MC68HC912B32's resources for execution. In this mode, the EVB cannot provide true emulation of a target system. These limitations are described in the following sections.

If target-system emulation is required, the EVB may be reprogrammed and controlled via the BDM interface. Operation as a target is described in **3.1.3 POD (Probe) Mode**.

3.9.1 On-Chip RAM

D-Bug12 requires 512 bytes of on-chip RAM for stack and variable storage. This usage is shown in Table 3-5.

3.9.2 On-Chip EEPROM

D-Bug12 occupies Flash EEPROM starting at address \$8000, as shown in Table 3-5. This area is thus not available for emulation of a target application.

3.9.3 SCI Port Usage

D-Bug12 requires the MCU's Serial Communications Interface (SCI) port for the terminal interface. The SCI port is either connected (default) or disconnected from the RS-232C RXD and TXD signals by means of jumpers W1 and W2.

3.9.4 Dedicated MCU Pins

As used on the EVB with D-Bug12, the following MCU lines perform specific functions. If an application requires their use, the EVB hardware and/or operating software must be custom-configured, or special precautions must be taken in the application code to avoid conflicts with the D-Bug12 usage.

PAD0 — EVB mode select pin (W3)

PAD1 — EVB mode select pin (W4)

PE5/MODA, and PE6/MODB — Sets MCU chip mode, normally single chip.

3.9.5 Terminal Communications

High baud rates occasionally result in dropped characters on the terminal display. This is not the result of a baud rate mismatch; it is due to the host processor being too busy or too slow to process incoming data at the selected baud rate. The D-Bug12 MD, MDW, T, and HELP commands may be affected by this problem. Sometimes the problem can be ignored without harm. If it requires correcting, try the following:

- Use a slower baud rate.
- Try a different communications program.
- In multitasking environments such as Windows 3.1 and the MacIntosh System 7, the problem can occur when several applications are running at once. Try closing unnecessary applications or exiting Windows.
- When using the MD, MDW, or T commands, try displaying fewer address locations or tracing fewer instructions at a time.



CHAPTER 4

HARDWARE REFERENCE

4.1 PCB DESCRIPTION

The EVB printed circuit board (PCB) is a 5.15 by 3.4 inch (13.1 by 8.64 cm) board with two layers.

Most of the connection points on the EVB use headers spaced on 1/10-inch (2.54 mm) centers, with the following exceptions:

- Subminiature D connector for the RS-232C interface
- External power-supply connections

4.2 CONFIGURATION HEADERS AND JUMPER SETTINGS

For maximum flexibility, the EVB uses two types of jumper headers:

Factory-installed headers are those most likely to be used for configuration without major alteration of the EVB's hardware operation. These headers are populated, and the factory-installed jumpers on them are preset for the default EVB hardware and firmware (D-Bug12) configurations. Table 4-1 lists these headers by function and describes their default and optional jumper settings.

Cut-trace header footprints offer EVB hardware options that are less likely to be changed. These footprints are not populated. The default connection between pins is a trace on the PCB. To change a cut-trace footprint, the PCB trace must be cut. To return to the original configuration, a header and a jumper must be installed to re-establish the shunt.

NOTE

Use of the cut-trace header footprints requires a thorough understanding of the MCU and of the EVB hardware. Refer to the *MC68HC912B32 Technical Summary* and to the EVB schematic diagram for design information.

CAUTION

When cutting a PCB trace to customize a header footprint, use a sharp blade. Be careful to avoid personal injury and not to cut adjacent traces.

Key to Table 4-1: Headers are depicted as viewed from either the component side as shown in Figure 1-1 or the solder side as shown in Figure 1-2.



2-pin header with no jumper installed *or*
2-pin cut-trace header with trace cut



2-pin header with jumper installed



2-pin cut-trace header with default trace intact



3-pin header with no jumper installed



3-pin header with jumper installed on left 2 pins

1-2

bold pin numbers indicate factory-default settings

1-2, cut

italics indicate alternate settings

Table 4-1. Jumper and Header Functions







| Diagram | Pins | Description |
|--|--------------------------|--|
| W1 | | RS-232C TXD Connection to SCI PS1 |
| 1  2 | 1-2 <i>cut</i> | TXD enabled TXD disconnected from SCI port |
| W2 | | RS-232C RXD Connection to SCI PS0 |
| 1  2 | 1-2 <i>cut</i> | RXD enabled RXD disconnected from SCI port |

Table 4-1. Jumper and Header Functions (continued)

| Diagram | Pins | Description |
|--|--|---|
| W3, W4 EVB Mode Selection | | |
| | W3-0 W4-0 W3-1 W4-0 W3-0 W4-1 W3-1 W4-1 | EVB mode — execution from Flash EEPROM (D-Bug12 default) Jump to EEPROM mode POD mode — remote BDM BOOTLOAD mode |
| W5, W6 MCU Mode Selection: MODB (W5), MODA (W6) | | |
| | W5 in W6 in | MODB MODA 0 0 Single Chip mode NOTE: If cut, these headers must be wired to external circuitry that provides the desired levels for MODA and MODB. Refer to Table 4-2. CPU Mode Selection . |
| W7 Vpp / Vdd Selection | | |
| | 2-3 1-2 | Connects MCU's Vpp pin to Vdd (non-programming mode) Connects MCU's Vpp pin to Vpp input header (programming mode) |
| W8 Vpp Input Header | | |
| | 1 2 | Vpp input Ground |
| W9 BDM IN | | |
| | 1 2 3 4 5 6 | Input to MCU BKGD Ground NC RESET* input to MCU NC Vdd NOTE: At reset, the BKGD input serves with MODA and MODB to determine the CPU mode. Refer to Table 4-2. CPU Mode Selection. |

Table 4-1. Jumper and Header Functions (continued)

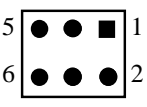
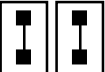
| Diagram | Pins | Description |
|---|----------------------------|--|
| W10 Vdd Connection to BDM OUT | | |
|  | 1-2 <i>cut</i> | Connects Vdd to BDM OUT pin 6 BDM OUT pin 6 open |
| W11 Reset Connection to BDM OUT | | |
|  | 1-2 <i>cut</i> | Connects MCU-generated reset (PT6) to BDM OUT pin 4 BDM OUT pin 4 open |
| W12 BDM OUT | | |
|  | 1 2 3 4 5 6 | BKGD output from MCU PT7 Ground NC Reset output from MCU PT6 NC Vdd |
| W13, W14 RS-232C Configuration (reserved) | | |
|  | in | reserved |
| W15 LVI Reset Enable | | |
|  | in <i>cut</i> | On-board low-voltage reset enabled On-board LVI reset disabled — provide external reset |
| W16 On-Board Crystal Enable | | |
|  | in <i>cut</i> | On-board crystal connected to MCU EXTAL On-board crystal disabled — use W16 to provide external clock to EXTAL |

4.3 POWER INPUT CIRCUITRY

The input power connector on the EVB is a 2-pin, lever-actuated connector (P5). Decoupling capacitors filter ripple and noise from the supply voltage.

4.4 TERMINAL INTERFACE

An RS-232C transceiver (U1A or U1B) links the MCU's Serial Communications Interface to the RS-232C DB-9 receptacle, P1. The communications parameters for this port are described in **2.5 Terminal Communications Setup**.

4.5 MICROCONTROLLER

The MC68HC912B32 is the first of a family of next generation M68HC11 microcontrollers with both on-chip memory and peripheral functions. The CPU12 is a high-speed, 16-bit processing unit. The programming model and stack frame are identical to those of the standard M68HC11 CPU. The CPU12 instruction set is a proper superset of the M68HC11 instruction set. All M68HC11 instruction mnemonics are accepted by CPU12 assemblers with no changes.

The EVB-resident MC68HC912B32 (U2) has seven modes of operation. These modes are determined at reset by the state of three mode pins — BKGD, MODB, and MODA — as shown in Table 4-2.

The EVB is factory-configured for MCU operation in the Normal Single Chip mode. In this mode of operation, all port pins are available to the user. On-chip Flash EEPROM is used for program execution, with byte-erasable EEPROM and some RAM available for user code/data. Although other MCU modes are available, the EVB was designed for the Single Chip mode of operation. There is no provision for external memory.

For more information on the CPU, refer to the *CPU12 Reference Manual*.

Table 4-2. CPU Mode Selection

| BKGD Through BDM IN | MODB Header W5 | MODA Header W6 | Mode Description |
|-------------------------------|--------------------------|--------------------------|--|
| 0 | 0 | 0 | Special Single Chip |
| 0 | 0 | 1 | Special Expanded Narrow |
| 0 | 1 | 0 | Special Peripheral |
| 0 | 1 | 1 | Special Expanded Wide |
| 1 | 0 | 0 | Normal Single Chip |
| 1 | 0 | 1 | Normal Expanded Narrow |
| 1 | 1 | 0 | Reserved (currently defaults to peripheral mode) |
| 1 | 1 | 1 | Normal Expanded Wide |

4.6 CLOCK CIRCUITRY

The EVB comes with a 16-MHz crystal, Y1, with appropriate startup capacitors. The board should be able to accommodate most crystals and ceramic resonators.

Header W16 may be used to disconnect Y1 from the MCU's on-chip oscillator. An external clock may then be supplied to EXTAL through W16.

4.7 RESET

The reset circuit includes a pull-up resistor, reset switch (S1), and a low-voltage inhibit device with a toggle voltage of 3.0 Vdc. This reset circuit drives the MCU's RESET* pin directly. Note that header W15 may be used to provide an alternate reset input.

4.8 LOW-VOLTAGE INHIBIT

Low voltage inhibition (LVI) uses a Motorola undervoltage sensing device (U1) to automatically drive the MCU's RESET* pin low when Vdd falls below U1's threshold. This prevents the accidental corruption of EEPROM data if the power-supply voltage should drop below the allowable level.

Depending on the date of manufacture, the sensing device installed on the EVB may have either a 2.7-volt or 4.5-volt threshold. U1 may be identified by part number:

MC34164P-3 — 2.7 Vdc

MC34164P-5 — 4.5 Vdc

If operation below U1's threshold (but no less than 2.7 Vdc) is required, one of two methods can be used:

1. Replace U1 with a device that has the required threshold voltage.
2. Cut the trace on header W15 to disconnect U1 from the RESET* line. If this is done, an external reset signal should be provided via W15 in case the supply voltage falls below the acceptable level.

4.9 BACKGROUND DEBUG MODE (BDM) INTERFACE

The MCU's serial BDM interface can be accessed through two 2x3 headers, BDM IN (W9) and BDM OUT (W12). The pin assignments are shown in Table 4-3.

The BDM interface may serve in two ways:

- as the "probe" interface through which a host EVB in POD mode controls a target system (see section 3.1.3)
- as the user interface with the EVB. This requires a development tool such as Motorola's Serial Debug Interface. For more information, refer to the *Motorola Serial Debug Interface User's Manual*.

Table 4-3. BDM Connector Pin Assignments

| Pin Number | Description | |
|---|---------------------|--|
| | W9 (in) | W12 (out) |
| 1 | BKGD input to MCU | BKGD output from MCU PT7 |
| 2 | Vss | Vss |
| 3 | no connection | no connection |
| 4 | RESET* input to MCU | Reset output from MCU PT6 ⁽¹⁾ |
| 5 | no connection | no connection |
| 6 | Vdd | Vdd ⁽¹⁾ |
| ⁽¹⁾ Refer to Table 4-1. Jumper and Header Functions . | | |

4.10 PROTOTYPE AREA

The EVB's prototype area allows construction of custom I/O circuitry that can be connected to the MCU's I/O lines through connectors P2, P3, P4, and P6. This area is a grid of holes (approximately 15 by 31) on 1/10-inch (2.54 mm) centers. This spacing accommodates most sockets, headers, and device packages.

Figure 1-1 shows the component-side view of the prototype area. Adjacent Vss (ground) and Vdd footprints are provided for wire-wrap pins.

4.11 MCU CONNECTORS

Four 2x20 header footprints, P2, P3, P4, and P6, surround the MCU and provide access to its I/O and bus lines. They may be populated with wire-wrap pins or strip headers for use as I/O connectors, connection points for instrumentation probes and target hardware, and connections to the prototype area described in section 4.10. Figure 4-1 and Figure 4-2 depict the pin assignments for these headers.

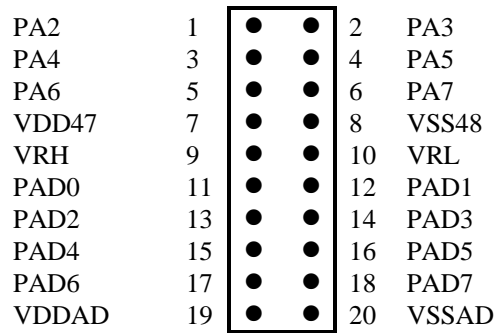

P2

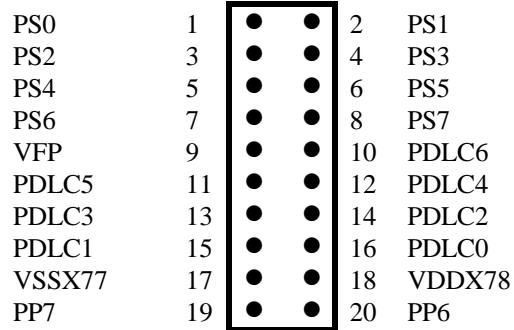

P3

Figure 4-1. MCU I/O Headers P2, P3

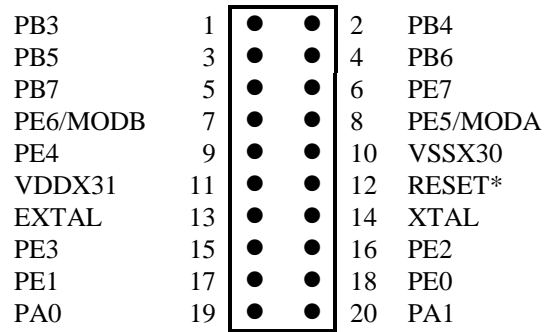
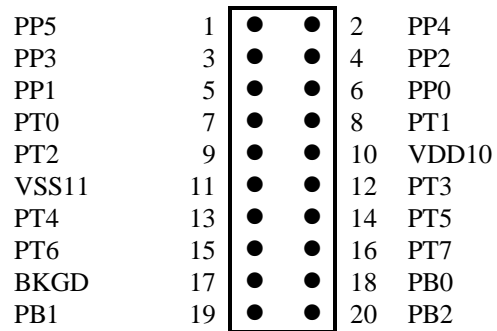
P4

P6
Figure 4-2. MCU I/O Headers P4, P6



APPENDIX A

S-RECORD FORMAT

DESCRIPTION

The S-Record format for output modules was devised for the purpose of encoding programs or data files in a printable format for transportation between computer systems. The transportation process can thus be visually monitored and the S-Records can be more easily edited.

S-RECORD CONTENT

When viewed by the user, S-Records are essentially character strings made of several fields that identify the record type, record length, memory address, code/data, and checksum. Each byte of binary data is encoded as a 2-character hexadecimal number: the first character represents the high-order 4 bits, and the second represents the low-order 4 bits of the byte.

The 5 fields that comprise an S-Record are shown below:

| TYPE | RECORD LENGTH | ADDRESS | CODE/DATA | CHECKSUM |
|------|---------------|---------|-----------|----------|
|------|---------------|---------|-----------|----------|

The S-Record fields are composed as follows:

| Field | Printable Characters | Contents |
|---------------|----------------------|--|
| Type | 2 | S-Record type - S0, S1, etc. |
| Record length | 2 | The count of the character pairs in the record, excluding the type and record length. |
| Address | 4, 6, or 8 | The 2-, 3-, or 4-byte address at which the data field is to be loaded into memory. |
| Code/data | 0-2n | From 0 to n bytes of executable code, memory-loadable data, or descriptive information. For compatibility with teletypewriters, some programs may limit the number of bytes to as few as 28 (56 printable characters in the S-Record). |
| Checksum | 2 | The least significant byte of the one's complement of the sum of the values represented by the pairs of characters making up the record length, address, and the code/data fields. |

Each record may be terminated with a CR/LF/NULL. Additionally, an S-Record may have an initial field to accommodate other data such as line numbers generated by some time-sharing systems.

Accuracy of transmission is ensured by the record length (byte count) and checksum fields.

S-RECORD TYPES

Eight types of S-Records have been defined to accommodate the several needs of the encoding, transportation, and decoding functions. The various Motorola upload, download, and other record transportation control programs, as well as cross assemblers, linkers, and other file-creating or debugging programs, utilize only those S-Records that serve the purpose of the program. For specific information on which S-Records are supported by a particular program, the user manual for that program must be consulted.

NOTE

D-Bug12 supports only the S1 and S9 records. All data before the first S1 record is ignored. Thereafter, all code/data records must be of type S1 until the S9 record terminates data transfer.

An S-Record format module may contain S-Records of the following types:

| | |
|-------|---|
| S0 | The header record for each block of S-Records. The code/data field may contain any descriptive information identifying the following block of S-Records. The address field is normally zeroes. <i>S0 records are ignored by the EVB.</i> |
| S1 | A record containing code/data and the 2-byte address at which the code/data is to reside |
| S2-S8 | <i>Ignored by the EVB</i> |
| S9 | The termination record for a block of S1 records. Address field may optionally contain the 2-byte address of the instruction to which control is to be passed. If not specified, the first entry point specification encountered in the object module input is used. There is no code/data field. |

Only one termination record is used for each block of S-Records. Normally, only one header record is used, although it is possible for multiple header records to occur.

S-RECORD EXAMPLE

Shown below is a typical S-Record format module, as printed or displayed:

```

S00600004844521B
S1130000285F245F2212226A000424290008237C2A
S11300100002000800082629001853812341001813
S113002041E900084E42234300182342000824A952
S107003000144ED492
S9030000FC
  
```

The above module consists of an S0 header record, four S1 code/data records, and an S9 termination record.

The S0 header record is comprised of the following character pairs:

| | |
|----------------|---|
| S0 | S-Record type S0, indicating a header record. |
| 06 | Hexadecimal 06 (decimal 6), indicating six character pairs (or ASCII bytes) follow. |
| 00 00 | Four-character 2-byte address field, zeroes. |
| 48 44 52 | ASCII H, D, and R - "HDR". |
| 1B | Checksum of S0 record. |

The first S1 code/data record is explained as follows:

| | |
|----------|---|
| S1 | S-Record type S1, indicating a code/data record to be loaded/verified at a 2-byte address. |
| 13 | Hexadecimal 13 (decimal 19), indicating 19 character pairs, representing 19 bytes of binary data, follow. |
| 00 00 | Four-character 2-byte address field; hexadecimal address 0000, indicates location where the following data is to be loaded. |

APPENDIX B

COMMUNICATIONS PROGRAM EXAMPLES

INTRODUCTION

In all of these examples, first follow the EVB startup procedure in section 3.2. When the startup procedure calls for setting up the host computer's communications program for terminal emulation, follow the steps in the examples.

Keyboard entries are illustrated in this appendix using the following conventions:

| | |
|------------|--|
| <ENTER> | Press the keyboard's Enter, Carriage Return, or Return key. |
| <ALT-P> | While holding down the ALTERNATE key, press the P key. |
| <CTL-\> | While holding down the CONTROL key, press the backslash key. |
| <filename> | Supply the appropriate file name when required. |

The stepwise procedures in this appendix are as accurate as possible. However, it is not feasible to document all of the communications programs that are available or to guarantee that a newer revision of a program behaves in exactly the same way as the version used to develop the procedure. For this reason, the steps are as generic as possible in their descriptions. They can thus serve as guidelines for programs not exemplified in this manual. *Always consult the documentation for the program being used.*

PROCOMM FOR DOS — IBM PC

Setup

To set up Procomm using DOS on an IBM-compatible PC for use as the EVB terminal, first refer to section 3.2 for the EVB startup procedure, which is inter-related with this example. Then follow these steps:

1. At the DOS prompt, Invoke the Procomm program by typing:

PROCOMM<RETURN>

2. Enter the Setup menu by pressing <ALT-S>.
3. From the TERMINAL SETUP submenu, select the following:

| | |
|--------------------|----------|
| Terminal emulation | WYSE 100 |
| Duplex | FULL |

| | |
|----------------------|------|
| Flow control | NONE |
| CR translation (in) | CR |
| CR translation (out) | CR |
| BS translation | DEST |
| BS key definition | BS |
| Line wrap | OFF |
| Scroll | ON |
| Break Length (ms) | 350 |
| Enquiry (CTRL-E) | OFF |

4. From the ASCII TRANSFER SETUP submenu, select the following:

| | |
|--------------------|-------------------|
| Echo locally | YES |
| Expand blank lines | YES |
| Pace character | 0 (ASCII) |
| Character pacing | 25 (1/1000th sec) |
| Line pacing | 10 (1/10th sec) |
| CR translation | NONE |
| LF translation | NONE |

5. Enter the Line Settings menu by pressing <ALT-P>. Select the following:

| | |
|-----------|--|
| baud rate | 9600 (or the customized EVB setting) |
| data bits | 8 |
| stop bits | 1 |
| parity | none |
| COM port | the host port used as the EVB terminal interface |

6. Reset the EVB by pressing S1 or by activating the appropriate custom reset circuitry.
7. Press <ENTER>. The D-Bug12 prompt should appear on the display. Continue with the startup procedure in section 3.2.

S-Record Transfers to EVB Memory

To load an S-Record file from the host computer into EVB memory using Procomm on an IBM-compatible host computer, first verify that the host is correctly configured and operating as the EVB terminal. Then follow these steps:

1. At the D-Bug12 prompt, enter the LOAD or VERF command with any parameters.

2. Instruct Procomm to send the S-Record file by pressing the <Page Up> key. Follow the onscreen instructions to select the S-Record file for transfer, using ASCII transfer protocol.

Upon completion of the S-Record file transfer, the D-Bug12prompt is displayed.

KERMIT FOR DOS — IBM PC

Setup

To set up Kermit using DOS on an IBM-compatible PC for use as the EVB terminal, first refer to section 3.2 for the EVB startup procedure, which is inter-related with this example. Then follow these steps:

1. At the DOS prompt, invoke Kermit by typing:

```
kermit<ENTER>
```
2. Set the baud rate to 9600 (or the customized EVB setting) by typing:

```
set baud 9600<ENTER>
```
3. Connect to the EVB by typing:

```
connect<ENTER>
```
4. Reset the EVB by pressing S1 or by activating the appropriate custom reset circuitry. The D-Bug12 prompt should appear on the display. Continue with the startup procedure in section 3.2.

S-Record Transfers to EVB Memory

To load an S-Record file from the host computer into EVB memory using Kermit on an IBM-compatible host computer, first verify that the host is correctly configured and operating as the EVB terminal. Then follow these steps:

1. At the D-Bug12 prompt, enter the LOAD or VERF command with any parameters.
2. "Escape" from the D-Bug12 prompt and start the Kermit file transfer by typing:

```
<CTL- ]>c  
push<ENTER>  
type <filename> > com1<ENTER>
```

Upon completion of the S-Record file transfer, the D-Bug12 prompt is displayed.

KERMIT — SUN WORKSTATION

Setup

To set up Kermit on the Sun Workstation for use as the EVB terminal, first refer to section 3.2 for the EVB startup procedure, which is inter-related with this example. Then follow these steps:

1. In a shell window, invoke Kermit by typing:

```
kermit<ENTER>
```

2. Set the serial port to the one in use for the EVB (ttya, ttyb, etc.) by typing:

```
set line /dev/ttya<ENTER>
```

3. Set the baud rate to 9600 (or the customized EVB setting) by typing:

```
set speed 9600<ENTER>
```

4. Connect to the EVB by typing:

```
connect<ENTER>
```

5. Reset the EVB by pressing S1 or by activating the appropriate custom reset circuitry. The D-Bug12 prompt should appear on the display. Continue with the startup procedure in section 3.2.

S-Record Transfers to EVB Memory

To load an S-Record file from the host computer into EVB memory using Kermit on a Sun Workstation, first verify that the host is correctly configured and operating as the EVB terminal. Then follow these steps:

1. In the shell window being used for the EVB terminal interface, at the D-Bug12 prompt, enter the LOAD or VERF command with any parameters.
2. Open a shell window separate from the one being used for the EVB terminal interface. In this window, type:

```
cat <filename> > /dev/ttya<ENTER>
```

Upon completion of the S-Record file transfer, the D-Bug12 prompt is displayed in the shell window being used for the EVB terminal interface.

MACTERMINAL — APPLE MACINTOSH

Setup

To set up MacTerminal on an Apple MacIntosh computer for use as the EVB terminal, first refer to section 3.2 for the EVB startup procedure, which is inter-related with this example. Then follow these steps:

1. Select the following from the Terminal Settings menu:

| | |
|---------------|------------------------|
| Terminal: | TTY |
| Cursor Shape: | Underline |
| Line Width: | 80 Columns |
| Select: | On Line Auto Repeat |
| Click on: | OK |

2. Select the following from the Compatibility Settings menu:

| | |
|---------------------|--------------------------------------|
| Baud Rate: | 9600 (or the customized EVB setting) |
| Bits per Character: | 8 Bits |
| Parity: | None |
| Handshake: | None |
| Connection: | Modem or Another Computer |
| Connection Port: | Modem or Printer |
| Click on: | OK |

3. Reset the EVB by pressing S1 or by activating the appropriate custom reset circuitry.
4. Press <ENTER>. The D-Bug12 prompt should appear on the display. Continue with the startup procedure in section 3.2.

S-Record Transfers to EVB Memory

To load an S-Record file from the host computer into EVB memory using MacTerminal, first verify that the host is correctly configured and operating as the EVB terminal. Then follow these steps:

1. At the D-Bug12 prompt, enter the LOAD or VERF command with any parameters.
2. From the MacIntosh File menu, select Send File - ASCII.
3. From the dialog box, select the S-Record file to be transferred.

4. Click on Send.

NOTES

1. S-Records are not displayed during the file transfer.
2. Following the file transfer, MacTerminal sends a carriage return-line feed pair, which D-Bug12 interprets as an erroneous command. To return to the D-Bug12 prompt, reset the EVB.

RED RYDER — APPLE MACINTOSH

Setup

To set up Red Ryder on an Apple MacIntosh computer for use as the EVB terminal, first refer to section 3.2 for the EVB startup procedure, which is inter-related with this example. Then follow these steps:

1. Launch the Red Ryder program.
2. Set up the Red Ryder parameters as follows:
 - 9600 baud (or the customized EVB setting)
 - 8 data bits
 - 1 stop bit
 - no parity
 - full duplex
3. Reset the EVB by pressing S1 or by activating the appropriate custom reset circuitry.
4. Press <ENTER>. The D-Bug12 prompt should appear on the display. Continue with the startup procedure in section 3.2.

S-Record Transfers to EVB Memory

To load an S-Record file from the host computer into EVB memory using Red Ryder, first verify that the host is correctly configured and operating as the EVB terminal. Then follow these steps:

1. At the D-Bug12 prompt, enter the LOAD or VRF command with any parameters.
2. From the MacIntosh File menu, select Send File - ASCII.
3. From the dialog box, select the S-Record file to be transferred.
4. Click on Send.



NOTE

S-Records are not displayed during the file transfer.

Upon completion of the S-Record file transfer, the D-Bug12 prompt is displayed.



APPENDIX C

D-BUG12 STARTUP CODE

The D-Bug12 startup code is located in Flash EEPROM starting at address range \$F700, as shown in Table 3-5.

To customize this startup code, it is necessary to alter the startup code in Flash EEPROM. For more information, refer to **Appendix E — EEPROM Bootloader**.

```
;
MAP_PAGE:    equ    $0000
;
;
PORTE:       equ    $0008+MAP_PAGE
DDRE:        equ    $0009+MAP_PAGE
PEAR:        equ    $000a+MAP_PAGE
MODE:        equ    $000b+MAP_PAGE
INITRG:      equ    $0011+MAP_PAGE
INITEE:      equ    $0012+MAP_PAGE
COPCTL:      equ    $0016+MAP_PAGE
CSCTL0:      equ    $003c+MAP_PAGE
CSCTL1:      equ    $003d+MAP_PAGE
CSSTR0:      equ    $003e+MAP_PAGE
PORTAD:      equ    $006f+MAP_PAGE
EEMCR:       equ    $00f0+MAP_PAGE
BPROT:       equ    $00f1+MAP_PAGE
FEELCK:      equ    $00f4+MAP_PAGE
;
MonRAMStart: equ    $0A00
MonRAMSize:  equ    $0200

RAM_START:   equ    $0800

RAMSize:     equ    $0400

STACKTOP:    equ    RAM_START+RAMSize ; stack at top of internal RAM

EE_START:    equ    $0d00              ; EEPROM located here out of reset

CustData:    equ    $f6c0
IOBase:      equ    CustData+15       ; location of user supplied base address
; of I/O registers
EEBase:      equ    CustData+19       ; location of user supplied base
; address of EEPROM

;
; xref    _BootLoad, _UserFnTable
; xdef    __MonStartup, _EEDelay
;
; switch .text
;
```

```

;*****
**
; INITIALIZATION
;
; The code in this section is initialization for the monitor on the EVB12B32
;*****
**

__MonStartup:
    lds    #STACKTOP                ; initialize monitor stack pointer
;
; Disable the COP watchdog by CR2:CR1:CR0 = 0:0:0
; COPCTL = $07 when reset in normal modes
; FCME and CRx bits are write once in normal modes
; COPCTL [ CME :FCME : FCM : FCOP ! DISR : CR2 : CR1 : CR0 ] $--16
;
    clr    COPCTL                    ; disable watchdog
;
; Clear all monitor RAM to start from a known state
;
    ldx    #MonRAMStart
ClrRAM:   clr    1,x+                  ; clear one and inc pointer
    cpx    #MonRAMStart+MonRAMSize
    bne    ClrRAM                    ; loop till RAM clear

; Enable pipe signals, E, low strobe and read/write in port E
; PIPEOE, NECLK, LSTRE and RDWE are write once in normal modes
; PEAR [ARSIE :CDLTE :PIPEOE :NECLK !LSTRE : RDWE : 0 : 0 ] $--0A
;
    ldaa   #$2c                      ; prevent later protection lock
    staa   PEAR                      ; PROTLK is write-once

; Without changing modes, enable internal visibility
; MODE [SMODN : MODB : MODA : ESTR ! IVIS : 0 : EMD : EME ] $--0B
;
    bset   MODE,$08                   ; set IVIS

; Enable EEPROM so monitor can program/erase bytes
; EEMCR [ 1 : 1 : 1 : 1 ! 1 : 1 : PROTLK: EERC ] $--F0
; BPROT [ 1 :BPROT6:BPROT5:BPROT4!BPROT3:BPROT2:BPROT1:BPROT0] $--F1
;
    ldaa   #$fc                      ; prevent later protection lock
    staa   EEMCR                    ; PROTLK is write-once
    clr    BPROT                    ; allow EE program and erase
;
; Disable writing to the on-chip Flash EEPROM
; FEELCK [ 0 : 0 : 0 : 0 : 0 : 0 : 0 : 0 : LOCK] $--F4
;
    ldaa   #$01                      ; write a 1 to the Flash LOCK bit to
;                                     ; disable accidental reprogramming of
    staa   FEELCK                    ; the flash memory (where we're located)
;
    ldd    EEBase                    ; get the user supplied base address of the
;                                     ; on-chip EEPROM
    oraa   #1                        ; make sure that the EEON bit remains set.
    staa   INITEE                    ; re-map the on-chip EEPROM.
;
    ldd    IOBase                    ; get the user supplied base address of the
;                                     ; on-chip I/O registers

```



```
    staa  INITRG           ; re-map the on-chip registers.

    ldx   #_UserFnTable    ; point to the table of user accessible
                          ; routines.
    jmp   [0,x]           ; the first entry is a pointer to main.
                          ; GO.....

;
;
;
;   This small subroutine is used to produce a delay of approximately 10 mS.
;   This delay is based on the following conditions:
;
;       1.) An 8.00 MHz E-clock
;       2.) Subroutine located in internal memory
;
;   This routine is called by D-Bug12's WriteEEByte() function (through a
;   pointer stored in the Customization Data Table).
;
_EEDelay:
    ldx   #20000           ; load delay count into x
DlyLoop:
    dex                       ; decrement count
    bne   DlyLoop          ; loop till done.
    rts                       ; return.

;
;

    end
```



APPENDIX D

D-BUG12 CUSTOMIZATION DATA

The customization data area, located in Flash EEPROM from \$FC60 to \$F6FF, allows users to change default data parameters used by D-Bug12. The data contained in this area is described by C data structure. The CustomData typedef is shown below. For those unfamiliar with C, an assembly language equivalent is also shown. The purpose of each field is explained in the following paragraphs.

C Format

```
typedef struct {
    Byte UserCCR;           /* User CPU Condition Code Register */
    Byte UserB;            /* User CPU B-accumulator */
    Byte UserA;            /* User CPU A-accumulator */
    Address UserX;         /* User CPU X-index register */
    Address UserY;         /* User CPU Y-index register */
    Address UserPC;        /* User CPU Program Counter */
    Address UserSP;        /* User CPU Stack Pointer */
    unsigned long SysClk;  /* System Clock frequency (in Hz) */
    Address IOBase;        /* Base address of I/O registers */
    unsigned int SCIBaudRegVal; /* Initial SCI BAUD reg. value */
    Address EEBase;        /* Base address of on-chip EEPROM */
    unsigned int EESize;   /* Size of the on-chip EEPROM */
    void (*Delay)(void);   /* Pointer to EEPROM delay routine */
    int AuxCmdCount;       /* No. of commands in aux cmd table */
    CmdTblEntryP AuxCmdTableP; /* Pointer to auxiliary cmd table */
} CustomData;
```

Assembly Format

```
org    $F6C0
;
CustData    equ    *
UserCCR     dc.b   $90      ; User CPU Condition Code Register
UserB       dc.b   $00      ; User CPU B-accumulator
UserA       dc.b   $00      ; User CPU A-accumulator
UserX       dc.w   $0000    ; User CPU X-index register
UserY       dc.w   $0000    ; User CPU Y-index register
UserPC      dc.w   $0000    ; User CPU Program Counter
UserSP      dc.w   $0A00    ; User CPU Stack Pointer
SysClk      dc.l   8000000   ; System Clock frequency (in Hz)
IOBase      dc.w   $0000    ; Base address of the I/O registers
SCIBaudRegVal dc.w   52      ; Initial SCI BAUD register value
EEBase      dc.w   $0D00    ; Base address of the on-chip EEPROM
EESize      dc.w   768      ; size of the on-chip EEPROM
EEDelay     dc.w   _EEDelay ; address of EEPROM program/erase delay routine
AuxCmdCount dc.w   0        ; number of commands in auxiliary command table
AuxCmdTableP dc.w   $0000   ; pointer to the auxiliary command table
;
```

INITIAL USER CPU REGISTER VALUES

The first seven fields in the `CustomData typedef struct` are used to provide default values for the user CPU12 registers. In this version of D-Bug12, the user CCR value is set to 0x90. This sets the S-bit, disabling the STOP instruction, and the I-bit, inhibiting IRQ interrupts. The X-bit is cleared to allow the use of the XIRQ interrupt as a user-supplied programmer's switch when operating in EVB mode. The user SP value is set to 0x0a00 when operating in EVB mode, which is one byte beyond the last on-chip RAM location available to the user. The CPU12 stack pointer points to the last byte pushed onto the stack.

When operating the M68EVB912B32 in POD mode, the values in the table for the CCR and the Stack Pointer are not used. Instead, when the target processor is reset by using the RESET command, the target's CCR is set to 0xd0. The stack pointer is set to one byte beyond the end of the target system's RAM, as specified by the DEVICE command.

In both operating modes, all of the other registers are initialized with the values contained in the customization data table.

SysClk FIELD

The `SysClk` field is used to inform D-Bug12 of the system clock frequency, M. Its value, in Hz, is set to 8,000,000. In this implementation, the E-clock frequency is the same as the system clock frequency, M. `SysClk` is used by the D-Bug12 BAUD command in calculating the new value of the SCI Baud register for the requested baud rate.

NOTE

It is the responsibility of the startup code to perform any actions necessary to set the system clock frequency. D-Bug12 *does not* set or change the system clock frequency using the `SysClk` value.

IOBase FIELD

The `IOBase` field defines the base address of the I/O registers. This address is used by D-Bug12 when accessing the I/O registers associated with the SCI and when programming or erasing the on-chip EEPROM. On the MC68HC912B32, the I/O registers are mappable to any 2-Kbyte memory space. Therefore, the `IOBase` entry should only be a multiple of 2048. The value of `IOBase` is set to 0x0000, which is the default address of the I/O registers for the MC68HC912B32.

NOTE

It is the responsibility of the startup code to set the base address of the I/O registers. D-Bug12 *does not* set or change the I/O register base address.

SCIBaudRegVal FIELD

The SCIBaudRegVal field is used to set the initial baud rate of the SCI used for console I/O by D-Bug12. Note that the value in SCIBaudRegVal is written directly to the Baud register of the EVB being used for the SCI terminal interface..

Note that the value in SCIBaudRegVal is *not* the desired baud rate. The calculation of the actual baud rate is not made by D-Bug12 because of the possibility of an invalid Baud register value. Without a valid Baud register value during SCI initialization, D-Bug12 would have no way to inform the user that a problem exists. Not all combinations of baud rates and system clock frequencies produce a valid Baud register value. The formula used to calculate the Baud register value is:

$$\text{SCIBaudRegVal} = \text{MCLK} \div (16 * \text{SCIBaudRate})$$

The initial Baud register value for this version of D-Bug12 is 52 (0x0034). At a system clock frequency of 8.0 MHz, this sets the EVB-to-terminal baud rate at 9600 baud.

NOTE

D-Bug12 takes care of initializing the SCI registers. The startup code should *not* initialize the SCI. The SCI data format is set to 8 data bits, 1-start bit, 1-stop bit, and no parity.

EEBase AND EESize FIELDS

The EEBase and EESize fields are used to describe the base address and range of the M68HC12's on-chip byte-erasable EEPROM. This information is used by D-Bug12's WriteMem() function to determine when a byte is being written to the on-chip EEPROM. D-Bug12 then calls its WriteEEByte() function to program the data into the on-chip EEPROM. On the MC68HC912B32, the EEPROM base address is mappable to any 4-Kbyte memory space and resides in the upper 768 bytes of the 4k block. Therefore, the EEBase entry should only be a multiple of 0x1000. The value of EEBase is set to 0x0d00, which is the default base address of the on-chip EEPROM for the MC68HC912B32. The value of EESize is also set to 0x0300 (768), which is the size of the on-chip EEPROM. Setting the value of EESize to zero disables the WriteMem() function's ability to write to on chip EEPROM.

NOTE

It is the responsibility of the startup code to set the base address of the EEPROM. D-Bug12 *does not* set or change the EEPROM base address.

EEPROM ERASE/PROGRAM DELAY FUNCTION POINTER FIELD

The (void)(* Delay)(void) field is a function pointer that points to an EEPROM program/erase delay routine. For the MC68HC912B32, the routine should produce a delay of 10 ms before it returns. The current implementation of the delay routine is nothing more than a software delay loop. The subroutine is located in the startup code area of the D-Bug12 Flash EEPROM from \$F700 to \$F77F.

AUXILIARY COMMAND TABLE ENTRIES

The last two entries in this table provide a mechanism to extend D-Bug12's command set. The `AuxCmdTableP` points to an auxiliary command table, and `AuxCmdCount` contains the number of entries in the auxiliary command table. The table is an array of entries of type `CmdTblEntry`. Each `CmdTblEntry` in the auxiliary command table has the following structure:

```
typedef struct {
    /* pointer to the command string */
    const char *CommandStr;

    /* pointer to the function that implements the command */
    int (*ExecuteCmd)(int argC, char *argv[]);

} CmdTblEntry, *CmdTblEntryP;
```

The first field is a character pointer to a null-terminated character array containing the command name. The command name string *must be in upper case*. The second field, a function pointer, points to a function that implements the new D-Bug12 command. The first parameter to this function is a count of the number of arguments that the command-line interpreter found on the command line. This count *includes* the command name itself. The command line may contain no more than a total of 10 arguments. The second function parameter is a pointer to an array of type `char *`. Each element points to one of the command-line parameters parsed by the command line interpreter.

The function implementing the new command can report any error conditions to the user in one of two ways:

If the error condition can be described by one of the error messages in the enumerated constant list below, the user-defined command should return the appropriate constant.

If some other message text needs to be conveyed to the user, the command should communicate the error message directly to the user by using the `printf()` function, which is one of the available user-callable C functions. In this case, the user-defined command should return an error code of `noErr`.

```
enum Error {
    noErr = 0,          /* Define No Error */
    WrongNumArgs = 6,  /* Wrong Number of Arguments */
    BadStartAddress = 7, /* Invalid Starting Address */
    BadEndAddress = 8,  /* Invalid Ending Address */
    StartEndError = 9,  /* Start Address Greater Than End Address */
    BadHexData = 10,   /* Invalid Hex Data */
    DataSizeError = 11, /* Data Out Of Range */
    NoTargetWrite = 12, /* Can't Write Target Memory */
};
```



APPENDIX E

EEPROM BOOTLOADER

The EEPROM bootloader occupies 1 Kbyte of erase-protected Flash EEPROM starting at address \$FC00. It is invoked when the EVB is started in BOOTLOAD mode (W3-1 and W4-1).

The bootloader may be used to program user code into byte-erasable (byte-erasable) EEPROM starting at address \$0D00 and/or Flash EEPROM starting at address \$8000. The user program in Flash EEPROM may then serve as the "boot" (startup) code when the board is placed in EVB mode (W3-0 and W4-0) or POD mode (W3-0 and W4-1) and reset.

D-Bug12 is overwritten when using Flash EEPROM for user code. But since the bootloader itself cannot be overwritten, it is always available for loading new user code or reloading D-Bug12.

NOTES

An additional 1 Kbyte of Flash EEPROM, starting at address \$F800, is reserved for future expansion of the bootloader. Thus, user code may only occupy the 30 Kbytes from \$8000 to \$F7FF.

Programs loaded and used in this manner cannot be used for true emulation of an application. Refer to the restrictions in section 3.9.

Use of the EEPROM bootloader is described in the following sections.

SERIAL S-RECORD BOOTLOADER

The bootloader contains a serial S-Record loader that can load assembled code from the host computer into either Flash EEPROM or byte-erasable EEPROM. It uses the SCI for communications with the host computer via the EVB's RS-232C interface. The only special requirements for the host computer's communications program are:

- It must operate at 9600 baud.
- It must wait for the prompt string '*' (the ASCII asterisk character) before sending a line of text to the EVB. This "handshaking" is necessary because of the variable amount of time required to program each S-Record into byte-erasable or Flash EEPROM. Byte-erasable EEPROM requires 10 ms per byte. Flash EEPROM typically requires less than 180 μ s per byte but can take as long as 3.5 ms.

When the EVB is restarted with jumpers W3 and W4 set for BOOTLOAD mode, the EEPROM

bootloader executes immediately. The bootloader's prompt appears on the host terminal:

```
(E)rase, (P)rogram or (L)oadEE:
```

Select the desired function by typing an upper- or lower-case "E", "P", or "L".

NOTES

Before selecting the Erase or Program function, apply Vpp to the EVB via header W8. Then move the jumper on header W7 to position 1-2. After programming is completed, remove Vpp and return W7 to position 2-3.

The starting address of the user code *must* be placed in the reset vector position (\$F7FE) of the alternate reset/interrupt vector jump table. For more information, see **Vector Jump Table: Interrupt and Reset Addresses** on page E-4.

The bootloader cannot be used with S-Records containing a code/data field longer than 64 bytes (S-Record length field greater than 67 bytes). Longer S-Records will cause the bootloader to crash and/or program incorrect data into EEPROM.

S-Records may contain ASCII "CR" and/or "LF" characters.

CAUTION

If an Erase or Program operation is unsuccessful after one or two attempts, check the Vpp connection on header W8 and measure the value of Vpp to verify compliance with the *MC68HC912B32 Electrical Specifications Supplement*. A Vpp voltage lower than that specified may cause the erase or program operation to fail. A Vpp voltage higher than that specified *may cause permanent damage to the device*.

(E)rase

This selection causes a bulk erase of Flash EEPROM except for the erase-protected area starting at address \$F800, which contains the bootloader program, the area reserved for bootloader expansion, and the reset/interrupt vector table. After the erase operation, a verify operation checks for proper erasure of all locations.

If the erase operation was successful, the message "Erased" is displayed, and the bootloader's prompt is redisplayed.

If any locations were found to contain a value other than \$FF, the message "Not Erased" is displayed, and the bootloader's prompt is redisplayed. If an error occurs, see the above **CAUTION**.

(P)rogram

In Flash programming mode, the bootloader sends an ASCII "*" (asterisk character) to the host computer, indicating that it is ready to receive an S-Record. The host then sends a single S-Record and waits for the "*" prompt from the bootloader before sending the next S-Record.

This process is repeated until the bootloader receives an end-of-file (S9) record from the host computer. If no S9 record is received, the bootloader continues to wait for another S-Record indefinitely. In this situation, the EVB must be reset to return to the bootloader's prompt (S-Records already loaded into Flash EEPROM are unaffected by the missing S9 record; reprogramming is not necessary).

If a Flash EEPROM location fails to program properly, the message "Not Programmed" is displayed, and the bootloader's prompt is redisplayed.

If an error occurs during programming, see the **CAUTION** on page E-3. If errors persist, the problem may be caused by an S-Record containing data that is outside the range of the available Flash EEPROM. The S-Record data must be within the range \$8000 - \$F7FF.

(L)oadEE

This selection causes a bulk erase of byte-erasable EEPROM in the address range \$0D00 - \$0FFF. After the erase operation, a verify operation checks for proper erasure of all locations. If any locations were found to contain a value other than \$FF, the message "Not Erased" is displayed, and the bootloader's prompt is redisplayed.

If the erase operation was successful, the bootloader sends an ASCII "*" (asterisk character) to the host computer, indicating that it is ready to receive an S-Record. The host then sends a single S-Record and waits for the "*" prompt from the bootloader before sending the next S-Record.

This process is repeated until the bootloader receives an end-of-file (S9) record from the host computer. If no S9 record is received, the bootloader continues to wait for another S-Record indefinitely. In this situation, the EVB must be reset to return to the bootloader's prompt (S-Records already loaded into EEPROM are unaffected by the missing S9 record; reprogramming is not necessary).

In case of errors during the (L)oadEE procedure, repeat the process several times. If the errors persist, it is possible that the MCU may be damaged.

VECTOR JUMP TABLE: INTERRUPT AND RESET ADDRESSES

The CPU's interrupt and reset vectors are located in the erase-protected area of Flash EEPROM and thus cannot be reprogrammed with the S-Record bootloader.

To allow the user code to specify interrupt and reset addresses, each member of the erase-protected vector table starting at address \$FFC0 contains a *pointer* to a vector jump table, which is located in user-programmable Flash EEPROM starting at address \$F7C0.

Each entry in the vector jump table occupies two bytes of memory, which is adequate for the addresses of user reset and interrupt service routines. The interrupt vector mapping is shown in the table below.

| Vector Address | CPU Interrupt | Jump Table Address |
|-----------------|-----------------------|--------------------|
| \$FFC0 - \$FFCF | reserved | \$F7C0 - \$F7CF |
| \$FFD0 | BDLC (J1850) | \$F7D0 |
| \$FFD2 | ATD | \$F7D2 |
| \$FFD4 | reserved | \$F7D4 |
| \$FFD6 | SCI0 | \$F7D6 |
| \$FFD8 | SPI | \$F7D8 |
| \$FFDA | Pulse Acc. Input Edge | \$F7DA |
| \$FFDC | Pulse Acc. Overflow | \$F7DC |
| \$FFDE | Timer Overflow | \$F7DE |
| \$FFE0 | Timer Channel 7 | \$F7E0 |
| \$FFE2 | Timer Channel 6 | \$F7E2 |
| \$FFE4 | Timer Channel 5 | \$F7E4 |
| \$FFE6 | Timer Channel 4 | \$F7E6 |
| \$FFE8 | Timer Channel 3 | \$F7E8 |
| \$FFEA | Timer Channel 2 | \$F7EA |
| \$FFEC | Timer Channel 1 | \$F7EC |
| \$FFEE | Timer Channel 0 | \$F7EE |
| \$FFF0 | Real Time Interrupt | \$F7F0 |
| \$FFF2 | IRQ | \$F7F2 |
| \$FFF4 | XIRQ | \$F7F4 |
| \$FFF6 | SWI | \$F7F6 |
| \$FFF8 | Illegal Opcode Trap | \$F7F8 |
| \$FFFA | COP Failure Reset | \$F7FA |
| \$FFFC | Clock Mon. Fail Reset | \$F7FC |
| \$FFFE | Reset | \$F7FE |

RELOADING AND CUSTOMIZING D-BUG12

D-Bug12 should be reloaded into Flash EEPROM when:

- user code has been programmed into Flash EEPROM, and it is desired to restore D-Bug12 as the boot program
- upgrading to a newer version of D-Bug12
- modifying the D-Bug12 startup code or customization data

Obtaining D-Bug12 Upgrades

Upgrades to D-Bug12 are made available for electronic downloading. S-Record files containing the latest version may be obtained from Motorola Advanced Microcontroller Division at the following locations:

BBS — (512) 891-3733 (FREE)

Telnet/FTP — freeware.aus.sps.mot.com

World Wide Web — <http://freeware.aus.sps.mot.com>

Reloading D-Bug12

Whether reloading D-Bug12 from an upgrade file or from the file shipped with the EVB package (on the IASM12 diskette), the S-Record file requires editing before programming it into Flash EEPROM. This is necessary to remove the S-Records containing the bootloader and vectors, which reside in erase-protected areas of Flash EEPROM. Failure to remove them will cause errors.

Using a text editor, prepare the D-Bug12 S-Record file as follows:

1. Search for the S-Record line that begins with "S123FC00".
2. Delete this line and *all* remaining S-Records *except for* the last line in the file, which is the S9 end-of-file record.

This removes the bootloader program and vector table from the file.

3. Make sure that no blank lines remain in the file, as they may cause the loading process to fail.

The S-Record file may now be programmed into Flash EEPROM, using the "E" and "P" bootloader procedures described in **Serial S-Record Bootloader** on page E-1.

Customizing D-Bug12

Two areas within D-Bug12 may be customized by the user:

customization data — located from \$F6C0 - \$F6FF. This area contains default data parameters that D-Bug12 uses for device initialization (e.g., baud rate for the communications interface).

startup code — from \$F700 - \$F77F. This area contains program code used by D-Bug12 to initialize the MC68HC912B32's hardware.

Appendix C — D-Bug12 Startup Code and **Appendix D — D-Bug12 Customization Data** contain detailed explanations and source listings for these two areas.

First, generate S-Record files for the new data, using an M68HC12-compatible assembler or C compiler.

Next, prepare the D-Bug12 S-Record file for loading and add the customized S-Records to it. Using a text editor, perform the following steps:

1. Search for the S-Record line that begins with "S123FC00".
2. Delete this line and *all* remaining S-Records *except for* the last line in the file, which is the S9 end-of-file record.

This removes the bootloader program and vector table from the file.

3. Search for the S-Record line that begins with "S120F6C0". *Replace* this line with the S-Record containing the new customization data.
4. Search for the S-Record line that begins with "S123F700". *Replace* this line *and* the next one, "S11FF720", with the S-Records containing the new startup code.
5. Make sure that no blank lines remain in the file, as they may cause the loading process to fail.

The S-Record file may now be programmed into Flash EEPROM, using the "E" and "P" bootloader procedures described in **Serial S-Record Bootloader** on page E-1.

INDEX

—A—

ASM command, 3-11
assembler
 program, 1-5, 2-4, 3-54
 single-line (D-Bug12), 3-11

—B—

background debug mode (BDM)
 as user interface, 1-5, 1-6, 2-3
 interface connectors, 4-6
 target-system interface, 3-2
BAUD command, 3-14
BF command, 3-15
BOOTLOAD mode, 3-3, 3-6, E-1
bootloader, EEPROM, E-1
BR command, 3-16
BULK command, 3-18
bulletin boards, 1-8, E-5
byte-erasable EEPROM. *See* EEPROM

—C—

CALL command, 3-19
clock
 external input, 4-6
 on-board, 4-6
code
 generation, 1-5, 3-54
 modifying D-Bug12, E-5
commands, D-Bug12
 ASM — Assembler/Disassembler, 3-11
 BAUD — Set Baud Rate, 3-14
 BF — Block Fill, 3-15
 BR — Breakpoint Set, 3-16
 BULK — Bulk Erase EEPROM, 3-18
 CALL — Call Subroutine, 3-19
 DEVICE — Specify Target MCU Device, 3-20
 EEBASE — Specify Target EEPROM Base Address, 3-23
 FBULK — Erase Target Flash EEPROM, 3-25
 FLOAD — Program Target Flash EEPROM, 3-27
 G — Go Execute a User Program, 3-29
 G — Go Till, 3-30
 HELP — Onscreen Help Summary, 3-31
 LOAD — Load S-Record File, 3-33
 MD — Memory Display, 3-34
 MDW — Memory Display, Word, 3-35
 MM — Memory Modify, 3-36
 MMW — Memory Modify, Word, 3-38
 MOVE — Move Memory Block, 3-40

NOBR — Remove Breakpoints, 3-41
RD — Register Display, 3-42
REGBASE — Specify Target EEPROM Register Address, 3-43
REGISTER NAME — Modify Register Value, 3-52
RESET — Reset Target MCU, 3-45
RM — Register Modify, 3-46
STOP — Stop Execution on Target MCU, 3-47
T — Trace, 3-48
UPLOAD — Display Memory, S-Record Format, 3-50
VERF — Verify S-Record File against Memory, 3-51
communications, BDM, 1-5, 1-6, 2-3, 3-2, 4-6
communications, EVB-host
 baud rate, 2-5, 3-14
 limitations, 3-57
 parameters, 2-4
 SCI port, 2-2
 software, 1-6, 2-4, B-1
configuration
 D-Bug12, D-1, E-5
 EVB, 2-1
 jumpers, 4-1
connectors
 locations, 1-3, 1-4
 P1 — SCI RS-232C port, 2-2, 2-3
 P2, P3, P4, P6 — MCU access, 1-5, 4-7
 P5 — power input, 2-2, 4-4
 types, 4-1
 W15 — external reset, 4-6
 W16 — external clock, 4-6
 W8 — Vpp, E-2
 W9, W12 — BDM interface, 4-6
CPU
 instruction translation, 3-11, 3-12
 modes, 4-5
 registers. *See* registers
 type. *See* MCU
customer support, 1-8

—D—

D-Bug12
 aborting a user program, 3-6
 command set, 3-8, 3-10
 command-line format, 3-7
 commands. *See* commands, D-Bug12
 configuration requirements, 1-5, 2-1
 customization data, D-1
 customizing, E-5
 description, 1-4, 1-6, 3-7
 generating user code, 1-5, 3-11, 3-54
 limitations imposed by, 3-55
 memory usage, 3-54, 3-55

operating, 3-4
 reloading, E-5
 resetting, 3-6
 stack pointer, 3-55
 starting, 3-3
 startup code, C-1
 startup modes, 1-5, 2-1, 3-3
 terminal interface, 1-5
 upgrades, E-5
 DEVICE command, 3-20

—E—

EEPROM. *See also* memory
 bootloader, E-1
 byte-erasable
 defined, 1-5
 map, 3-55
 erasing, 3-18, 3-25, E-1
 Flash
 defined, 1-5
 map, 3-55
 low-voltage protection, 4-6
 operating modes, 1-4, 1-5, 2-1
 programming, 3-27, 3-33, 3-54, E-1
 starting execution from, 3-1, 3-3, E-1
 usage, 3-54, 4-5

evaluation board. *See* EVB

EVB

component placement, 1-3
 configuring, 2-1
 description, general, 1-1
 description, hardware, 4-1
 features, 1-1
 firmware. *See* D-Bug12
 functional overview, 1-4
 operating modes
 BOOTLOAD, 3-3, 3-6
 EVB, 3-1, 3-4
 JUMP-EEPROM, 3-1, 3-4
 POD, 3-2, 3-5
 operating procedures, 3-4
 packing list, 2-1
 restrictions on use, 3-55
 specifications, 1-7
 startup procedure, 3-3
 unpacking, 2-1

EVB mode, 3-1, 3-4

—F—

FBULK command, 3-25
 file transfers, 3-33, 3-51, 3-54, B-1
 firmware. *See* D-Bug12
 Flash EEPROM. *See* EEPROM
 FLOAD command, 3-27

—G—

G command, 3-29
 GT command, 3-30

—H—

headers
 connector, 4-1. *See also* connectors
 cut-trace, 4-1
 description, 4-1, 4-2
 jumper, 4-1. *See also* jumper settings
 HELP command, 3-31

—I—

IASM12 assembler, 1-5, 2-4, 3-54

—J—

JUMP-EEPROM mode, 3-1, 3-4
 jumper settings, 1-2, 4-1, 4-2

—L—

LOAD command, 3-33
 low voltage inhibit (LVI), 4-6

—M—

M68EVB912B32 Evaluation Board. *See* EVB
 MC68HC912B32 Microcontroller Unit. *See* MCU
 MCU
 access interface, 1-5, 4-7
 description, 4-5
 location, 1-3
 modes, 4-5
 restrictions on use, 1-6, 3-54, 3-55
 type, 1-7, 4-5
 MCUasm assembler, 1-5, 2-4
 MD command, 3-34
 MDW command, 3-35
 memory. *See also* EEPROM, RAM
 limitations, 3-54, 3-56
 map, 3-54, 3-55
 microcontroller unit. *See* MCU
 MM command, 3-36
 MMW command, 3-38
 modes, CPU, 4-5
 modes, operating. *See* EVB modes
 monitor program. *See* D-Bug12
 MOVE command, 3-40

—N—

NOBR command, 3-41

—P—

P1 — SCI RS-232C port, 2-2, 2-3
P2, P3, P4, P6 — MCU access, 1-5, 4-7
P5 — power input, 2-2, 4-4
packing list, 2-1
POD mode, 3-2, 3-5
power
 distribution, 4-4, 4-7
 input circuit and protection, 4-4
 input connector, P5, 2-2
 low-voltage inhibit, 4-6
 supply, connecting to, 2-2
 supply, requirements, 1-6, 1-7
printed circuit board
 description, 4-1
 layout, 1-3, 1-4
program abort, 3-6, D-2
prototype area, 1-5, 4-7

—R—

RAM. *See also* memory
 map, 3-55
 usage, 3-54, 4-5
RD command, 3-42
REGBASE command, 3-43
REGISTER NAME command, 3-52
registers, 3-16, 3-19, 3-29, 3-30, 3-42, 3-46, 3-48, 3-52, 3-55, D-1
reset, 1-5, 2-1, 2-5, 3-6, 4-5, 4-6
RESET command, 3-45
RM command, 3-46
ROM. *See* EEPROM
RS-232C interface, 2-2, 3-56

—S—

S1. *See* switches
SCI port
 baud rate, 3-14
 configuration, 2-2
 usage, 1-5, 1-6, 2-2, 2-3, 3-56
serial communications interface. *See* SCI port
Serial Debug Interface (SDI), 1-5, 1-6, 2-3, 4-7
specifications, EVB, 1-7
S-Records, 3-33, 3-51, A-1
STOP command, 3-47
switches, 1-5
 locations, 1-3
 S1 — reset, 3-6

—T—

T command, 3-48
target
 BDM interface, 3-2
 execution control, 3-3
 MCU type, 3-2

parameters, 3-2
programming, 3-3
terminal
 baud rate, 2-5, 3-14
 cabling, 2-3
 communications parameters, 2-4
 communications software, 1-6, 2-4, B-1
 connectors, 2-2
 interface circuitry, 4-5
 limitations, 3-57
 requirements, 1-6
 SCI port, 1-5, 2-2, 4-5
 setup, 2-2, 2-4, 4-5

—U—

UPLOAD command, 3-50

—V—

vectors
 jump table, E-3
 memory area, 3-55
VERF command, 3-51

